

Pack 10

LaFerrari

1:8 SCALE

THE ULTIMATE HYPERCAR
ULTIMATE PERFORMANCE
ULTIMATE STYLE

AGORA
MODELS®



STAGE 73 THE FRONT RIGHT WHEEL ARCH PANEL

DESIGNED FOR EXCEPTIONAL AERODYNAMIC FEATURES AND TO ENHANCE FRESH AIR INFLUENCE FROM OUTSIDE, THE FRONT OF THE LAFERRARI HAS AN AGGRESSIVE APPEARANCE.

PARTS LIST

NO.	PART	QUANTITY	MATERIAL
1	Front right wheel arch panel	1	Metal
2	Cover	2	ABS
3	Screw type A	10	Metal
4	Screw type B	1	Metal
5	Screw type FF*	2	Metal
6	Screw type X	2	Metal
7	Screw type D	2	Metal
8	Screw type G	2	Metal
9	Screw type GG	1	Metal
10	Replacement bonnet hinges	2	Metal

* Screws type FF are provided with this stage



THE CIRCUIT BOARD

In this stage you will start to connect the wiring to the circuit board. The table opposite and the image below give a reference for plugging the labelled wires into the sockets. Sockets A and B have extensions pre-fitted.

PART	LABEL	CIRCUIT BOARD SOCKET	PINS
Dashboard LED	Unlabelled	A	2
Rear boot LED	B	B	2
Cooling system speaker	C	C	2
Interior light LED	D	D	2
Brake light LEDs	E	E	4
Headlight LEDs	G	G	4
Accelerator switch	H	H	2
Brake pedal switch	I	I	2
Battery compartment	K	K	2
Power switch	P	P	2
Door switches	L	L/R/CLOSE	4
Right door motor	M2/R	M1/R	4
Left door motor	M1/L	M2/L	4

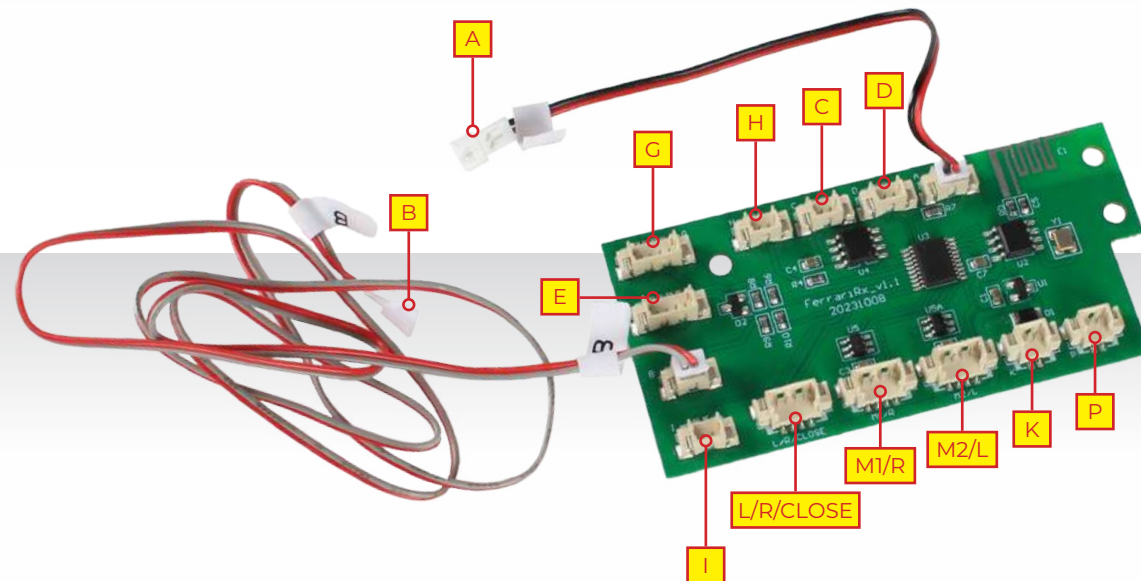

THE CIRCUIT BOARD

You can also refer to this diagram to check the correct connections for the different electronic parts.

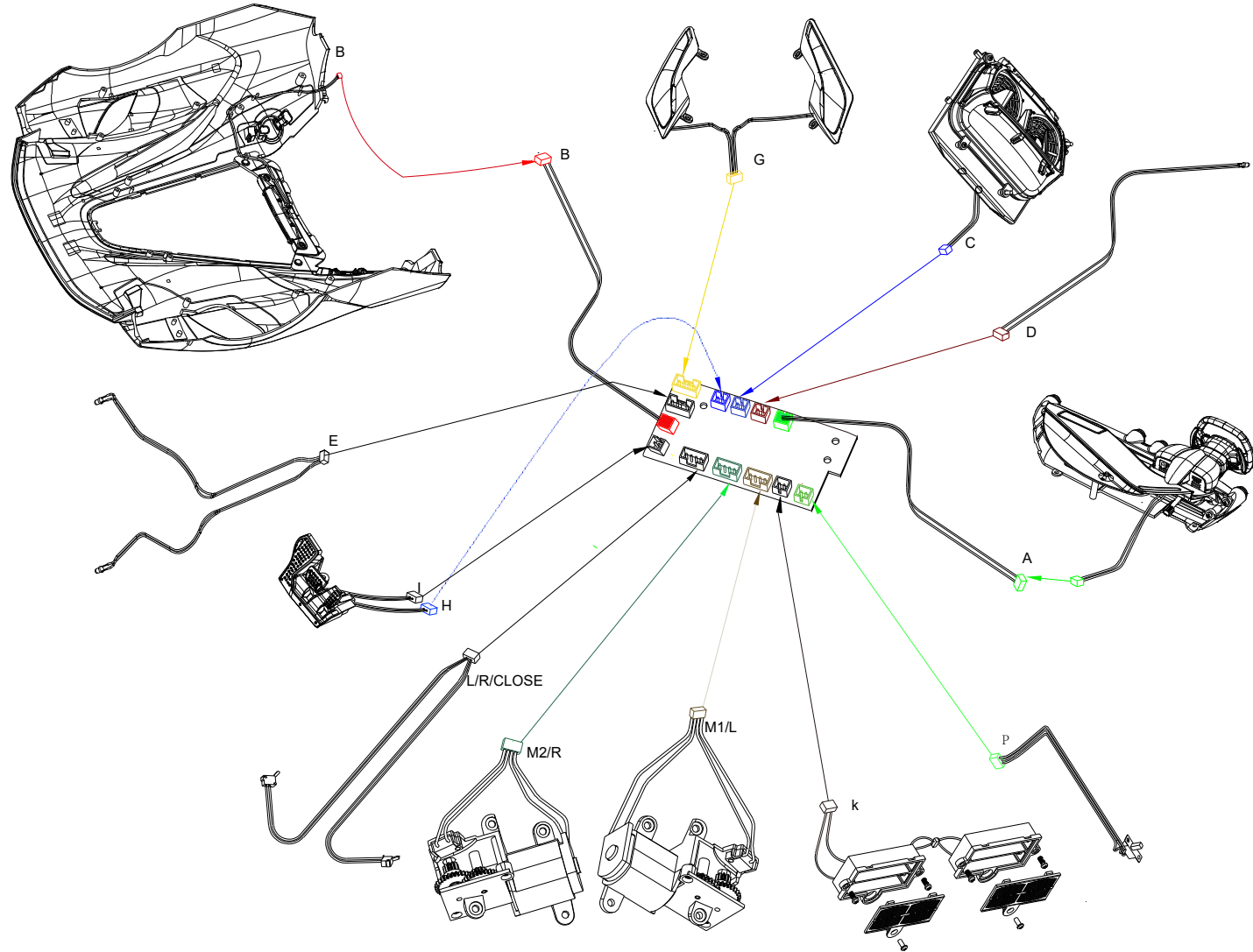

STEP 1

Fit the dashboard assembly (stage 15) over the steering shaft and into position as shown. Secure with two type G screws (8) at the points indicated by the white arrows and a type GG screw (9) at the point circled in yellow.

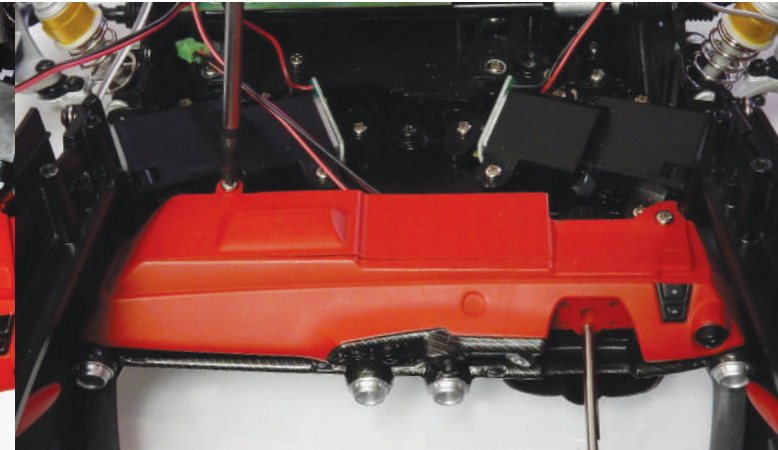
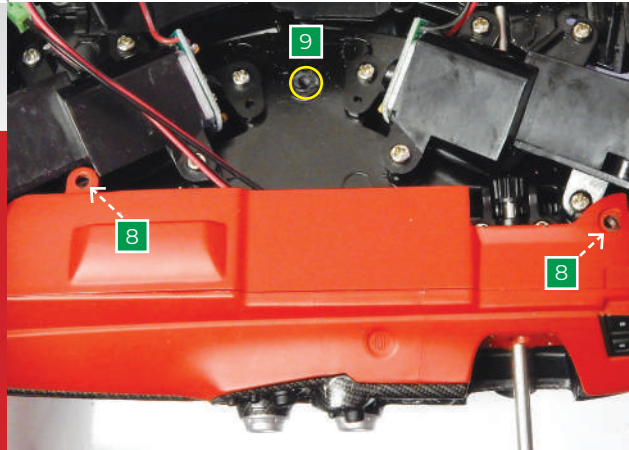

STEP 2

Fit the steering wheel onto the steering shaft and test the steering by turning the wheel left and right.



STEP 3

Connect the dashboard plug to the wire on the circuit board labelled 'A' as indicated by the yellow circle.

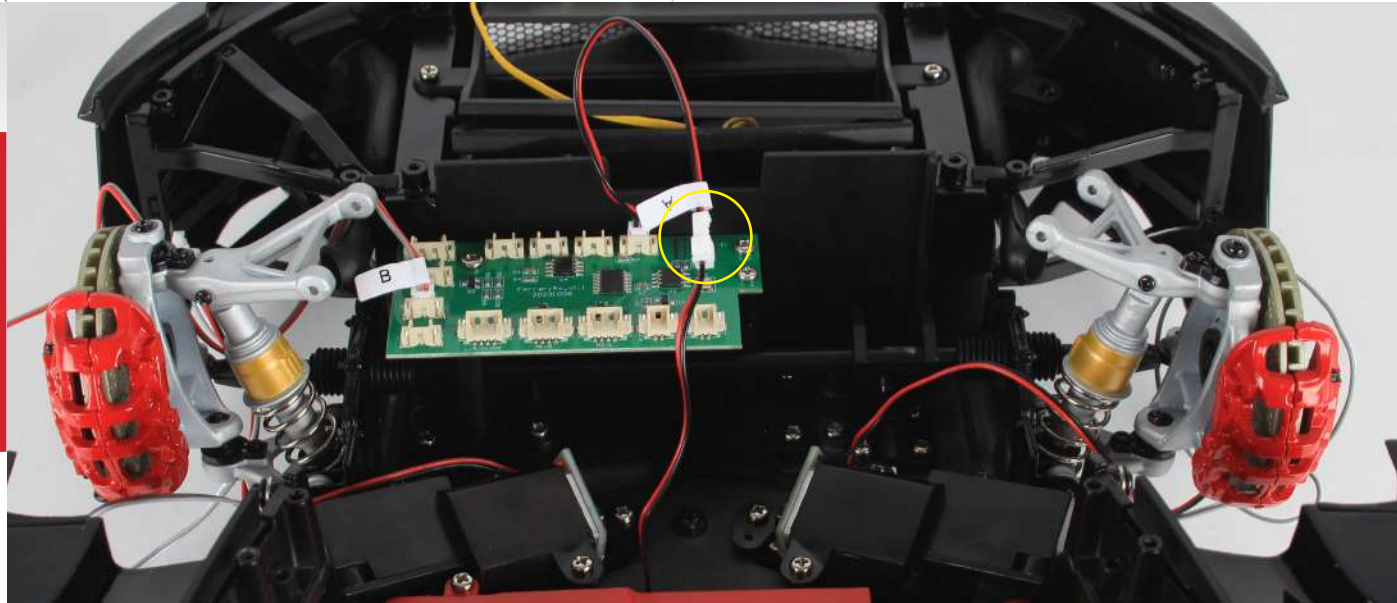

STEP 4

Take the front bonnet assembly (stage 11) and remove the cylinder from the piston and set it aside.



STEP 5

Unscrew the two hinges and piston (circled).



STEP 6

Fix the replacement hinges (10) using the same two type C screws, then fit the piston back in place using the same type D screw.



STEP 7

Fit the cylinder into the bonnet cylinder bracket (stage 71).



STEP 8

Peel the backing from the double-sided tape and stick the bracket in place on the chassis as shown.



STEP 9

Align the bonnet and fit the piston into the cylinder as shown, then secure the left hinge using a type D screw (7).

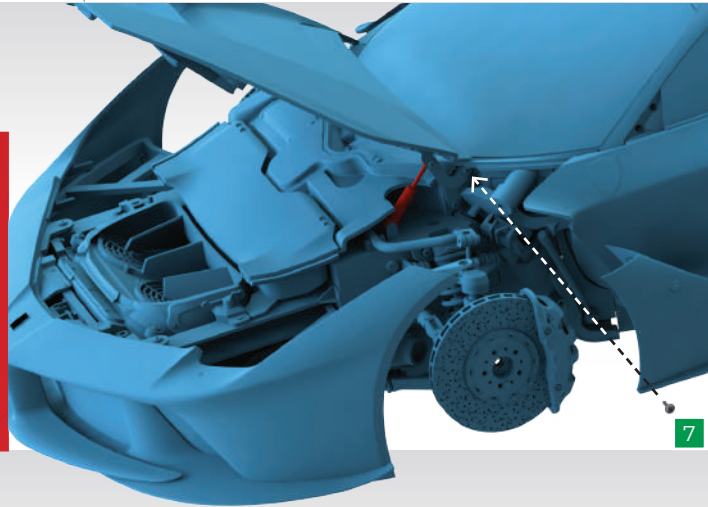

STEP 10

Secure the right hinge with a type D screw (7).

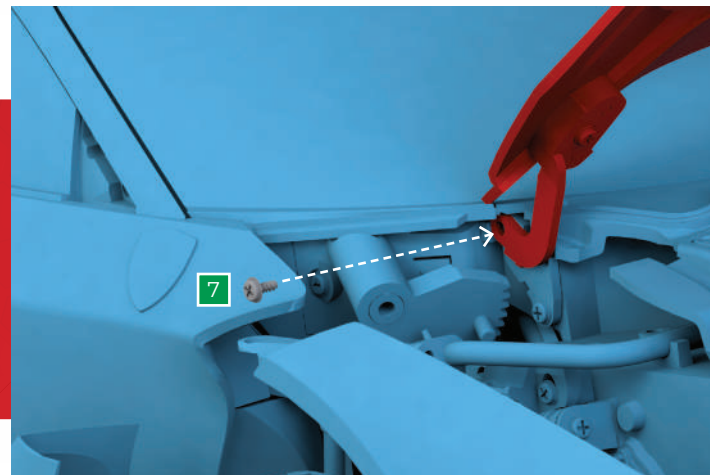

STEP 11

Position the front left wheel arch panel (stage 72) and secure using two type A screws (3) and a type X screw (6) as shown.

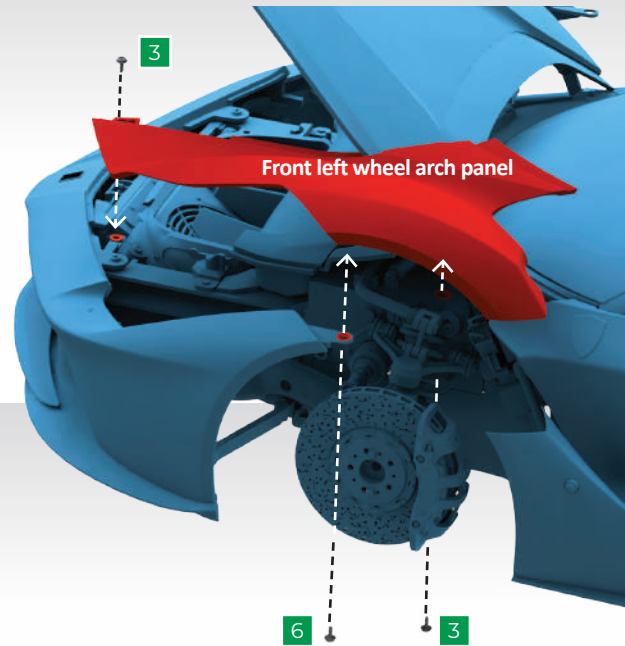

STEP 12

Position the passenger seat (stage 13) into the cockpit cradle (stage 26) and secure it with a type B screw (4).

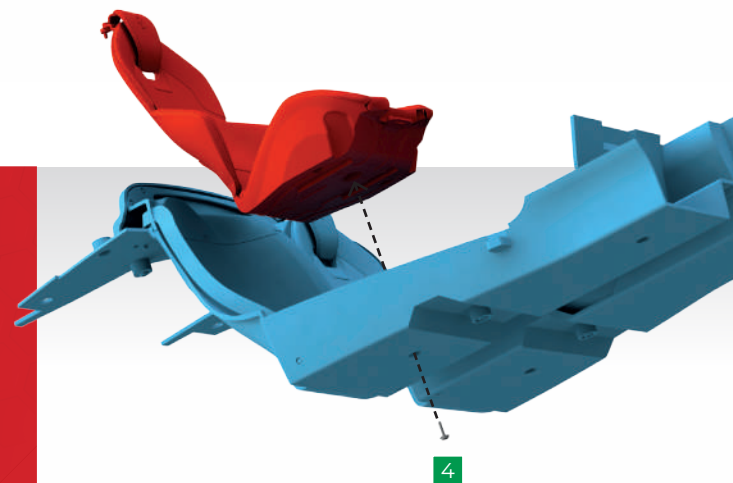

STEP 13

Fit the cockpit cradle onto the model. Secure it with four type A screws (3) at the front and two type FF screws (5) at the rear. Take care with the wires as indicated in the images below.

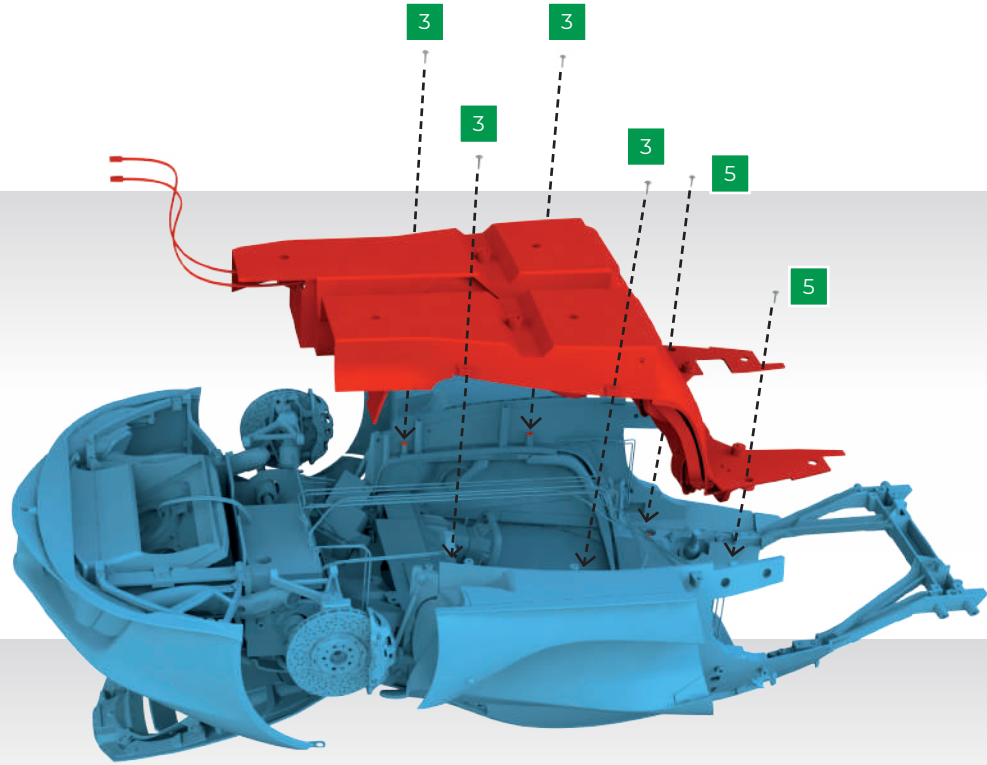

Make sure not to trap the rear wires underneath the cockpit cradle. There is a gap (circled yellow) in the cradle for the interior LED wire and recharging socket cable to fit through.

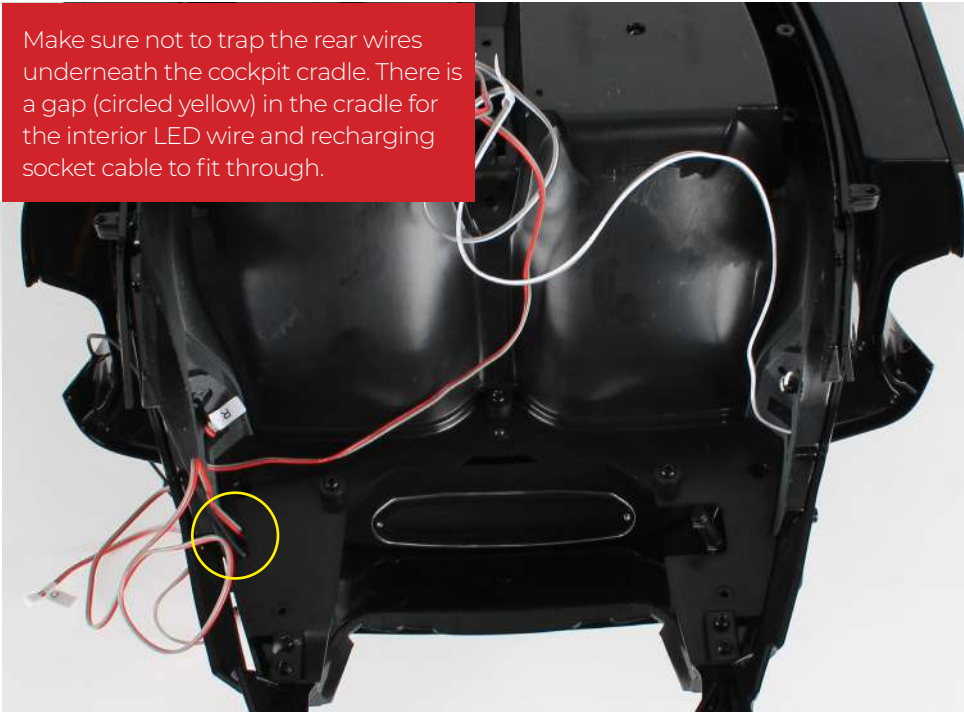

Fit the white and grey wire of the left door motor into the gap (circled yellow), hiding it underneath the driver's footwell and out to the front.

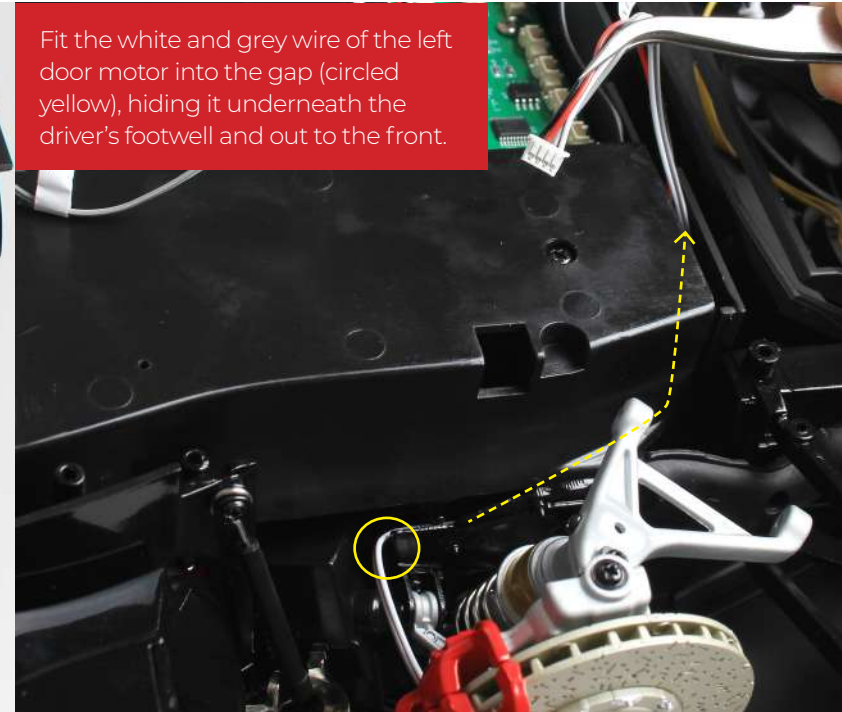

STEP 14

Connect the accelerator and brake pedal plugs (labelled "H" and "I") into the corresponding sockets on the circuit board.

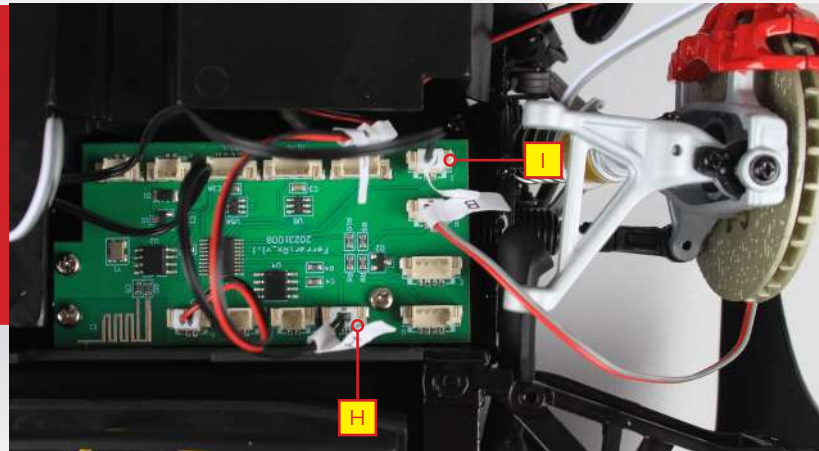

STEP 15

Connect the four-pin door motor plugs (labelled "M2/R" and "M1/L") into the sockets as shown.

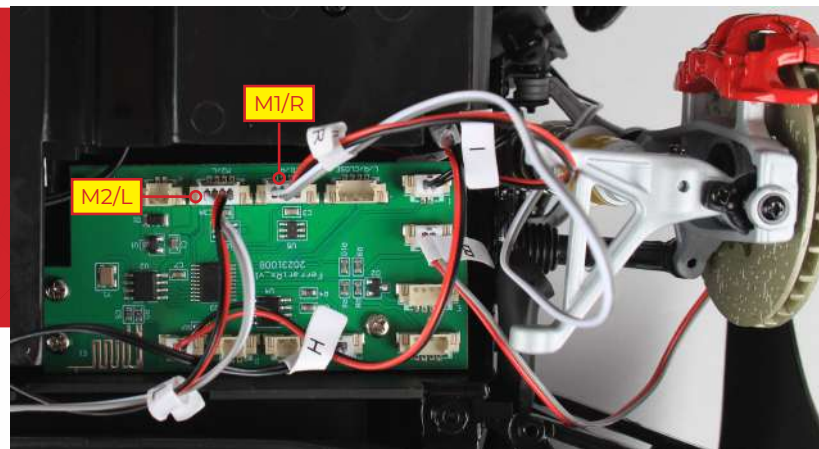

STEP 16

Connect the two-pin plug from the cooling system (labelled "C") into the corresponding socket.

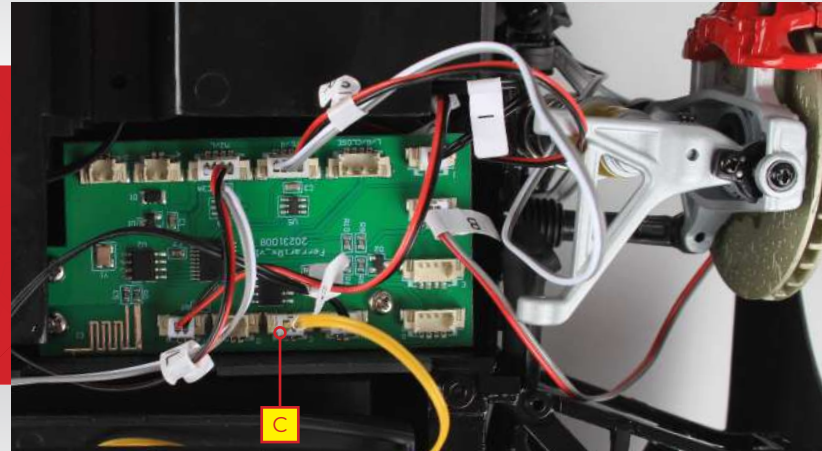

STEP 17

Take the wires at the rear of the assembly and connect the four-pin door switch plug (labelled "L") into the L/R/CLOSE socket and interior LED plug (labelled "D") into its corresponding socket.

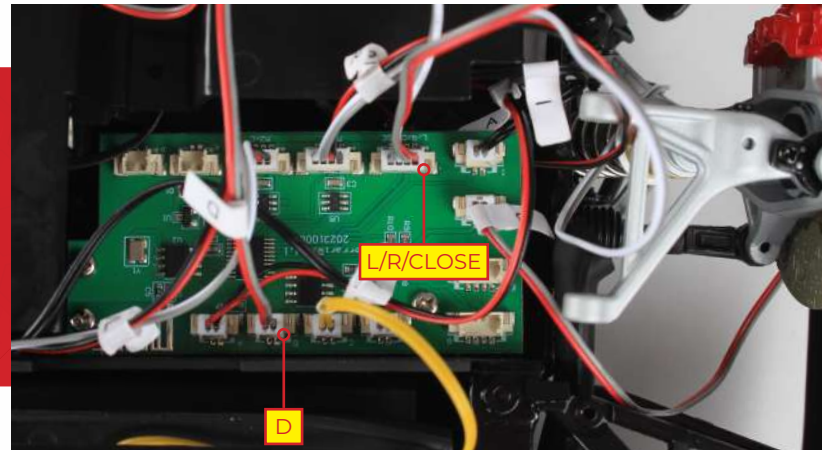

STEP 18

Once the plugs are all connected, route the wires through the tunnel in the cockpit cradle for the next step.

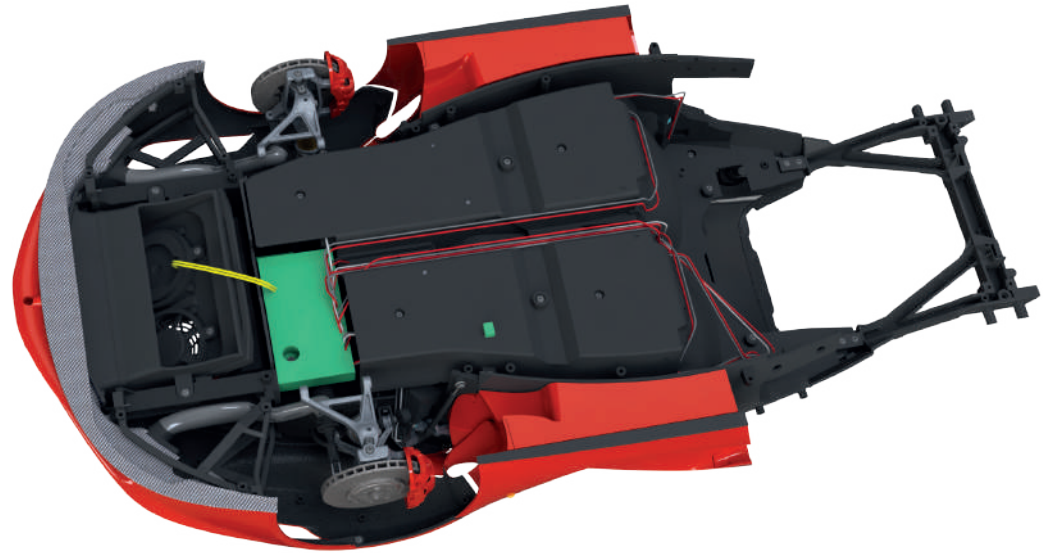

STEP 19

Fit the insulating bulkhead (supplied in stage 68) and fix it to the model using two type A screws (3).

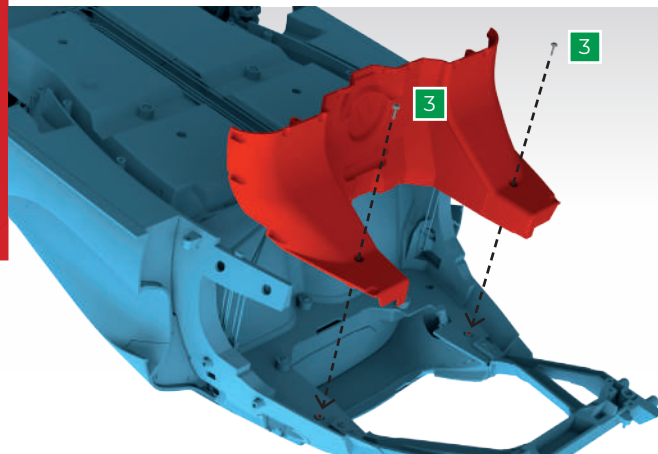

STEP 20

Fit the front right wheel arch panel (1) in position and secure it using two type A screws (3) and one type X screw (6).

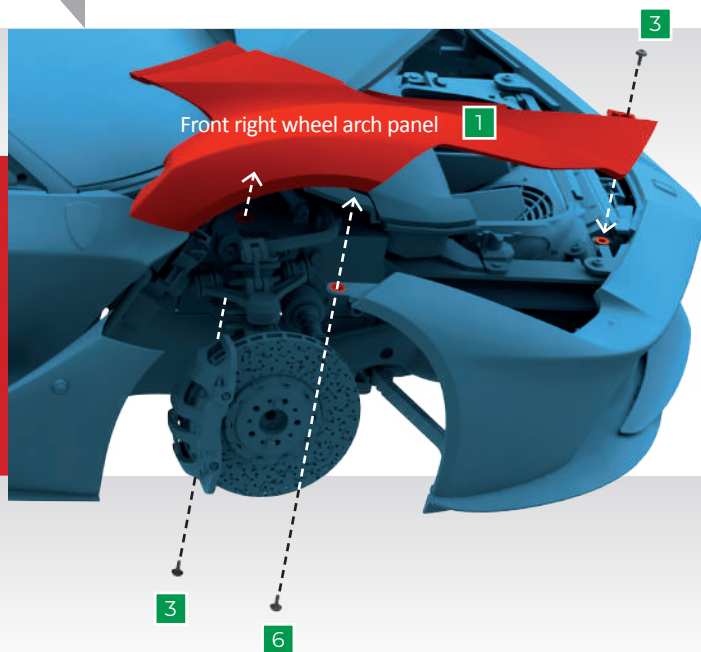

STEP 21

Fit the two covers (2) at the front of the model as shown.

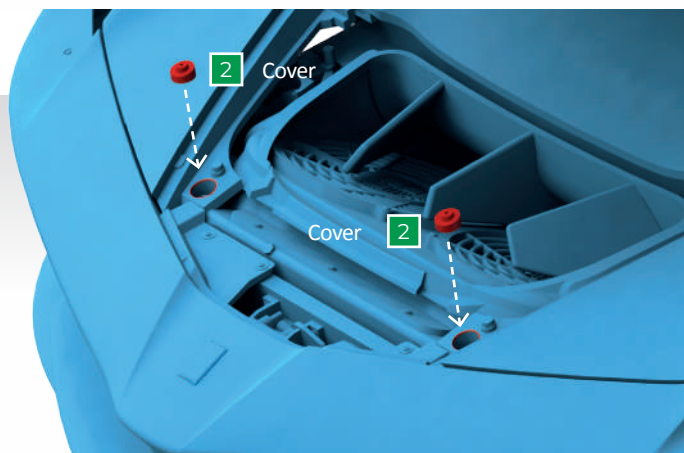

STAGE COMPLETE

With these parts installed, the front section of your LaFerrari is almost complete.



STAGE 74 THE FRONT LEFT MUDGUARD LINING

EVERY DETAIL OF THE 1:8 SCALE LAFERRARI IS REPRESENTED, INCLUDING BARELY VISIBLE COMPONENTS SUCH AS THE LINING OF THE MUDGUARDS

PARTS LIST

NO.	PART	QUANTITY	MATERIAL
1	Mesh	1	Metal
2	Front left mudguard lining	1	ABS
3	Screw type H	2	Metal
4	Screw type P	1	Metal
5	Screw type A	2	Metal
6	Screw type O	2	Metal

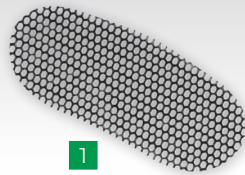

1



2



3

4



5



6



1

2

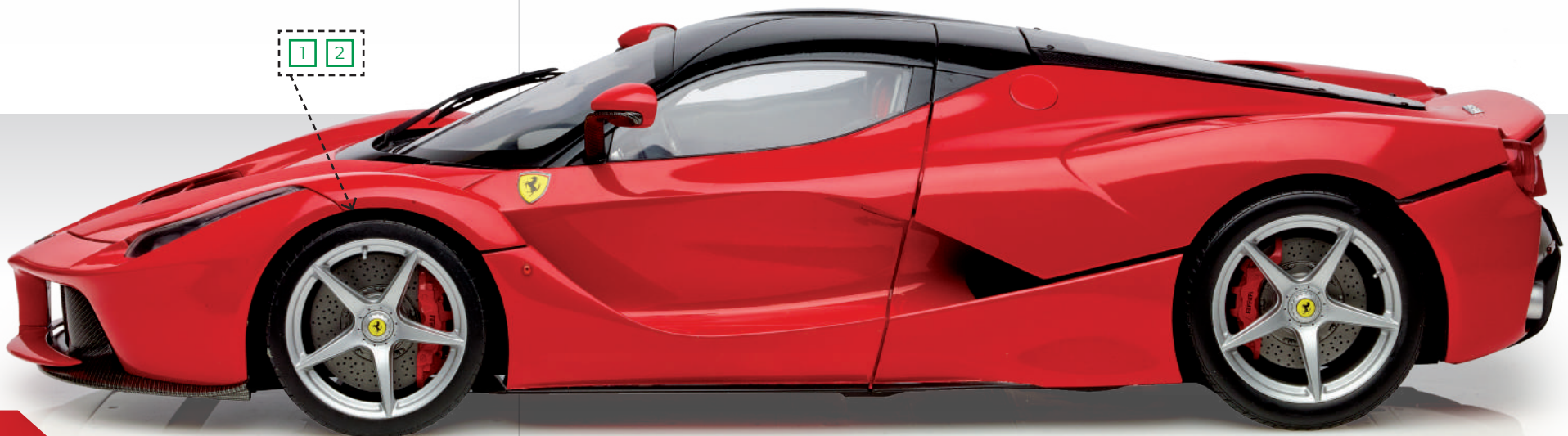

STEP 1

Fit the front left side panel (from stage 54) to the underside of the model and secure with two type A screws (5).

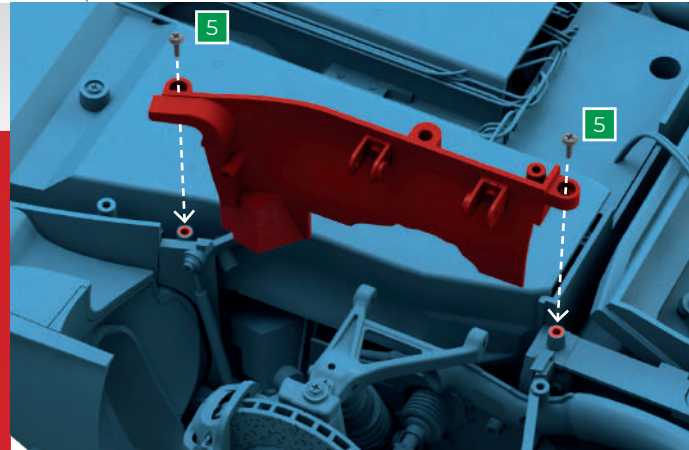

STEP 2

Fit the lower arm of the front left suspension into the brackets on the side panel and secure with two type O screws (6).

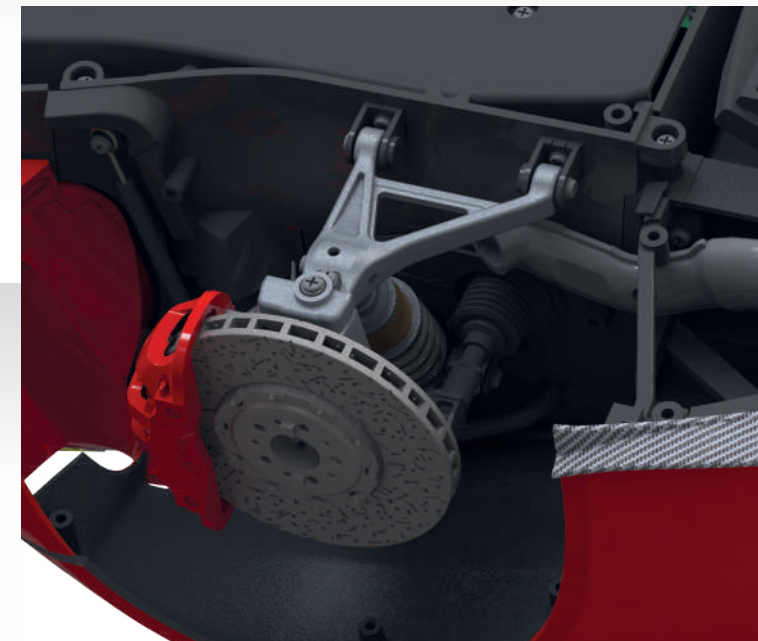
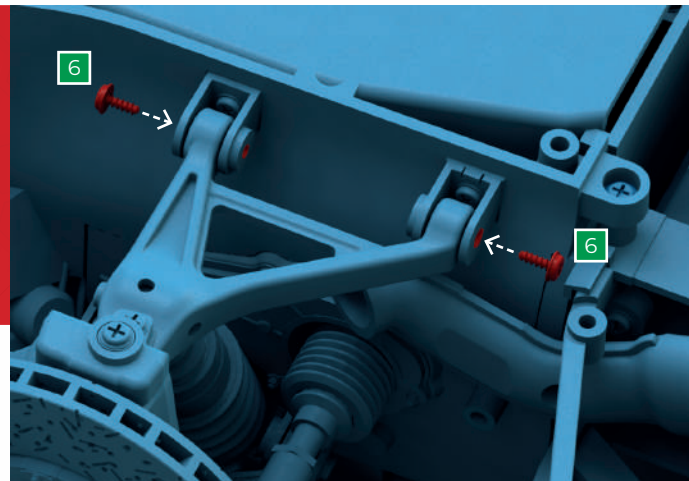

STEP 3

Position the front left mudguard lining (2) in position and secure using two type H screws (3) from the top and one type P screw from the side (4).

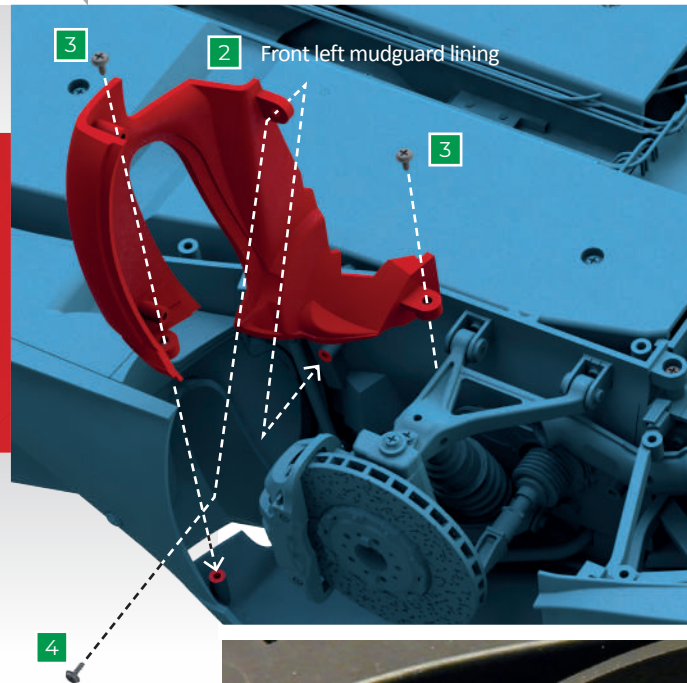

STAGE COMPLETE

The front left suspension is now complete. The mesh will be used in stage 76, so store it safely until needed.

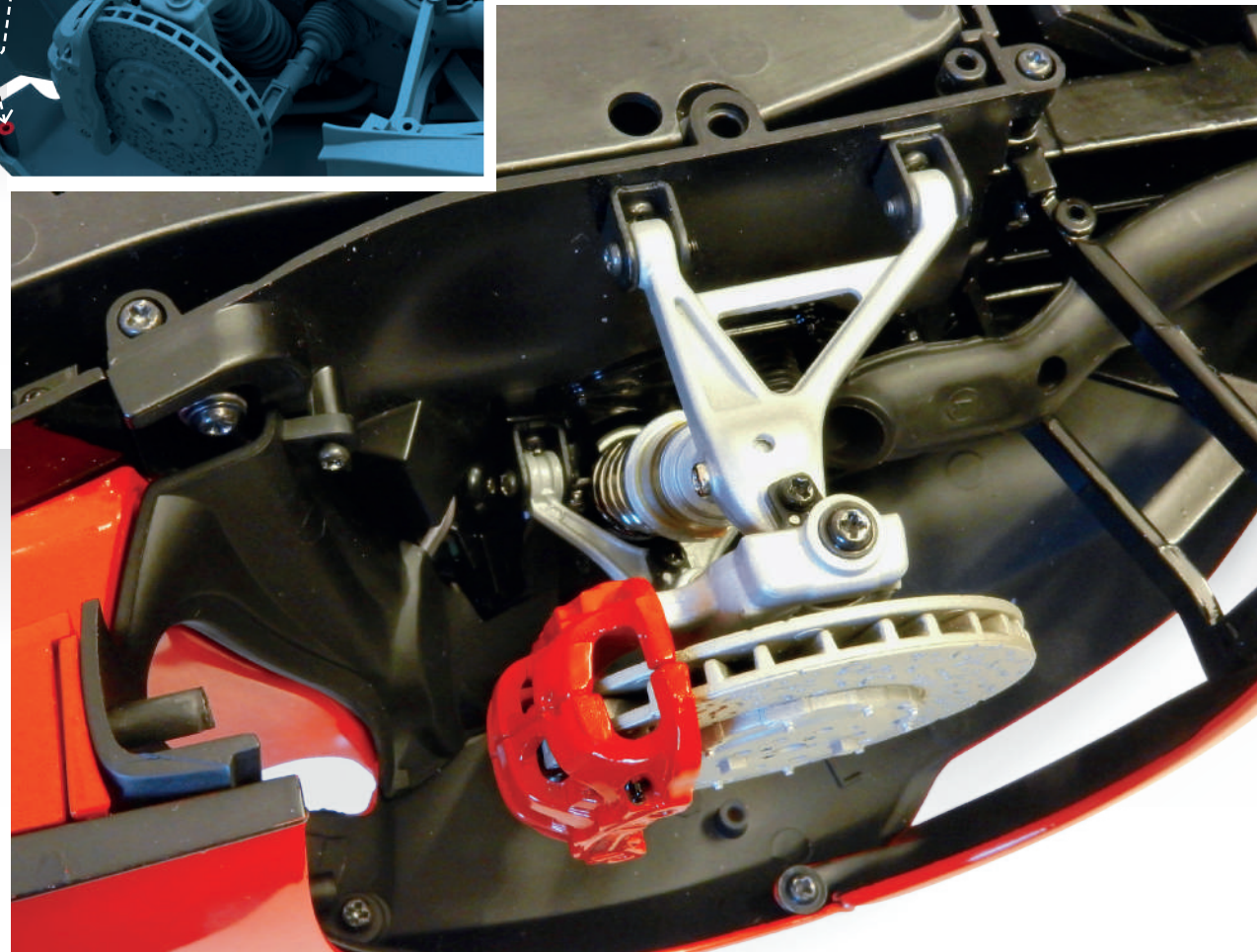

STAGE 75 THE FRONT RIGHT MUDGUARD LINING

YOUR MODEL IS CHARACTERISED
BY ITS ATTENTION TO DETAIL,
WITH A WIDE RANGE OF COLOURS,
MATERIALS AND FINISHES -
EVEN FOR THE HIDDEN DETAILS

PARTS LIST

NO.	PART	QUANTITY	MATERIAL
1	Front right mudguard lining	1	ABS
2	Mesh	1	Metal
3	Screw type A	2	Metal
4	Screw type O	2	Metal
5	Screw type H	2	Metal
6	Screw type P	1	Metal

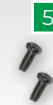
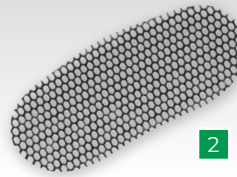

STEP 1

Fit the front right side panel (from stage 54) to the underside of the model and secure with two type A screws (3).

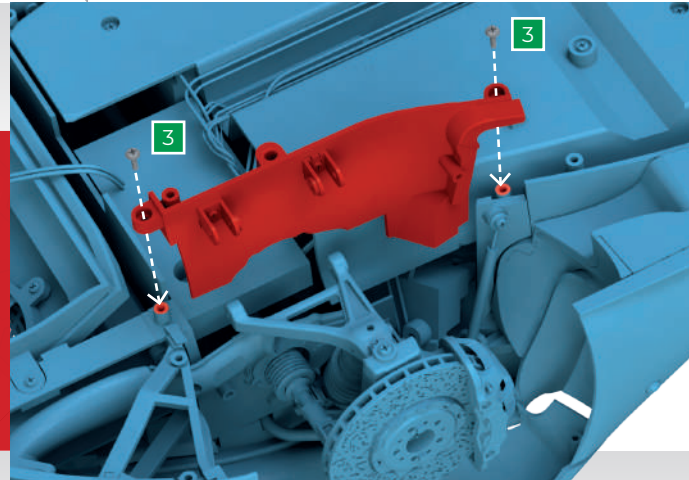

STEP 2

Fit the lower arm of the front right suspension into the brackets on the side panel and secure with two type O screws (4).

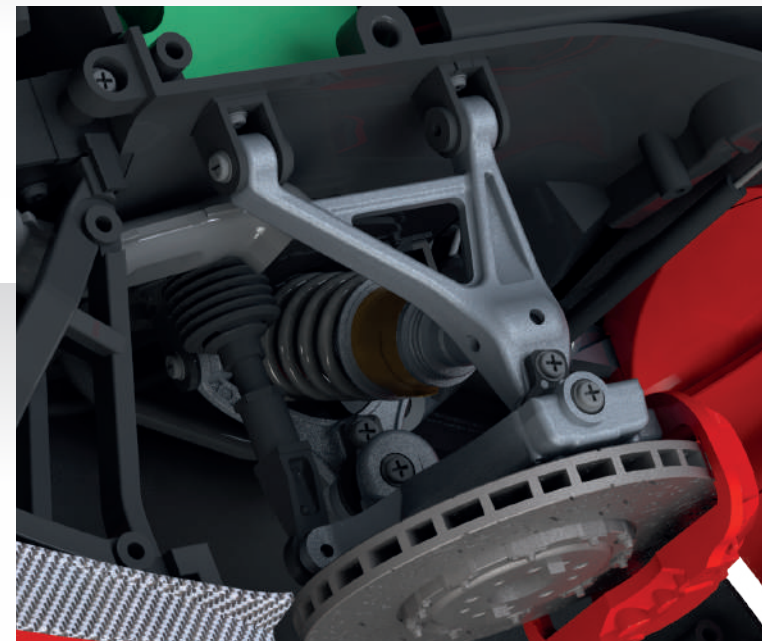
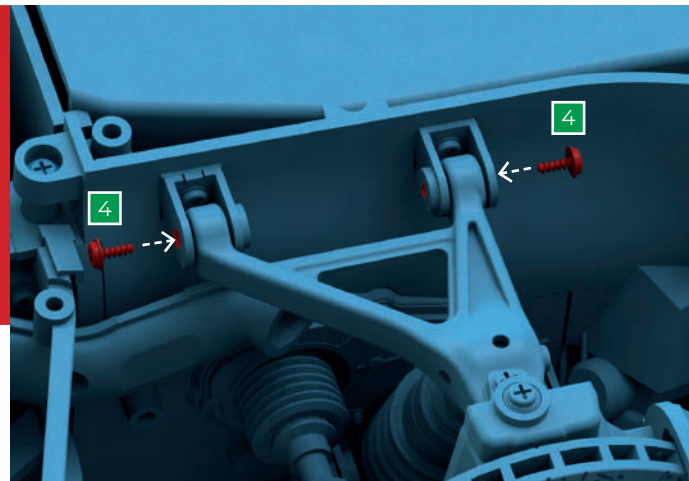

STEP 3

Position the front right mudguard lining (1) and secure using two type H screws (5) from above and one type P screw (6) from the side.

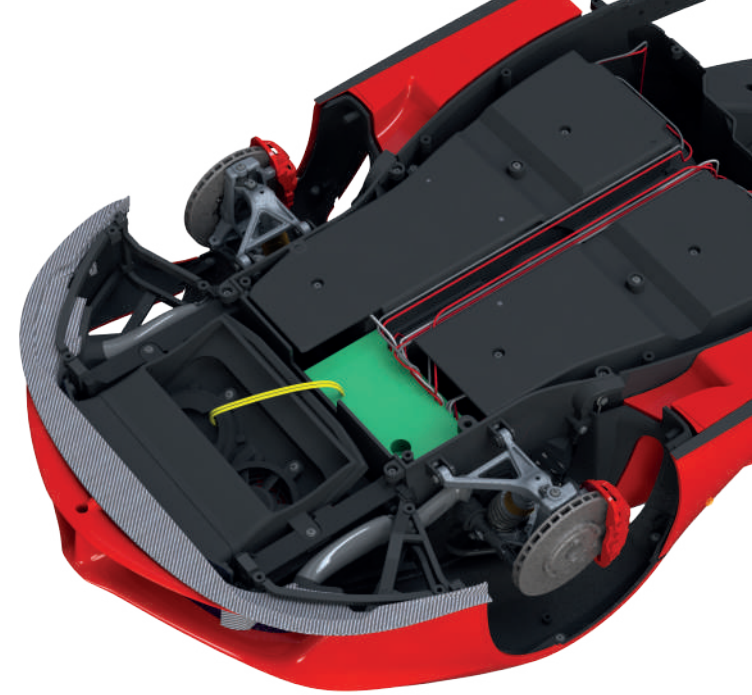
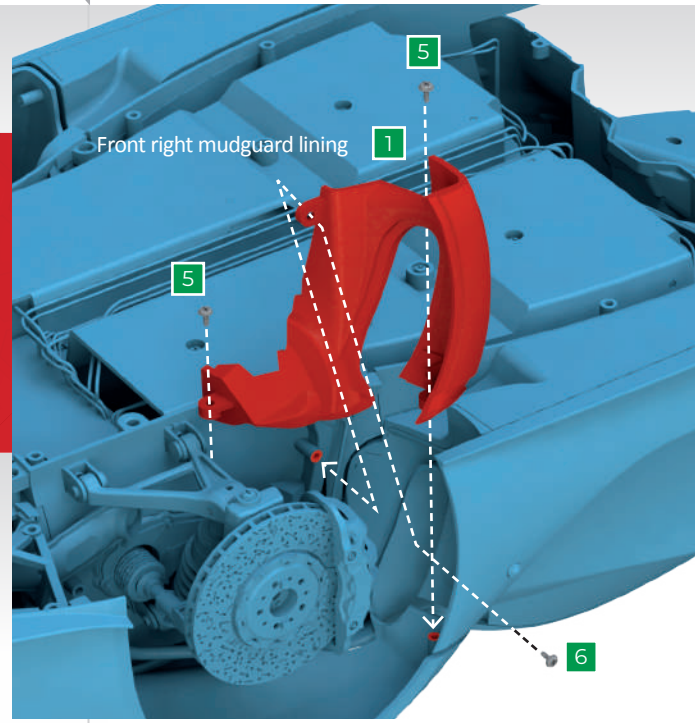

STAGE COMPLETE

The front right suspension is complete. You can test the working suspension by manually lowering and raising the brake disc.

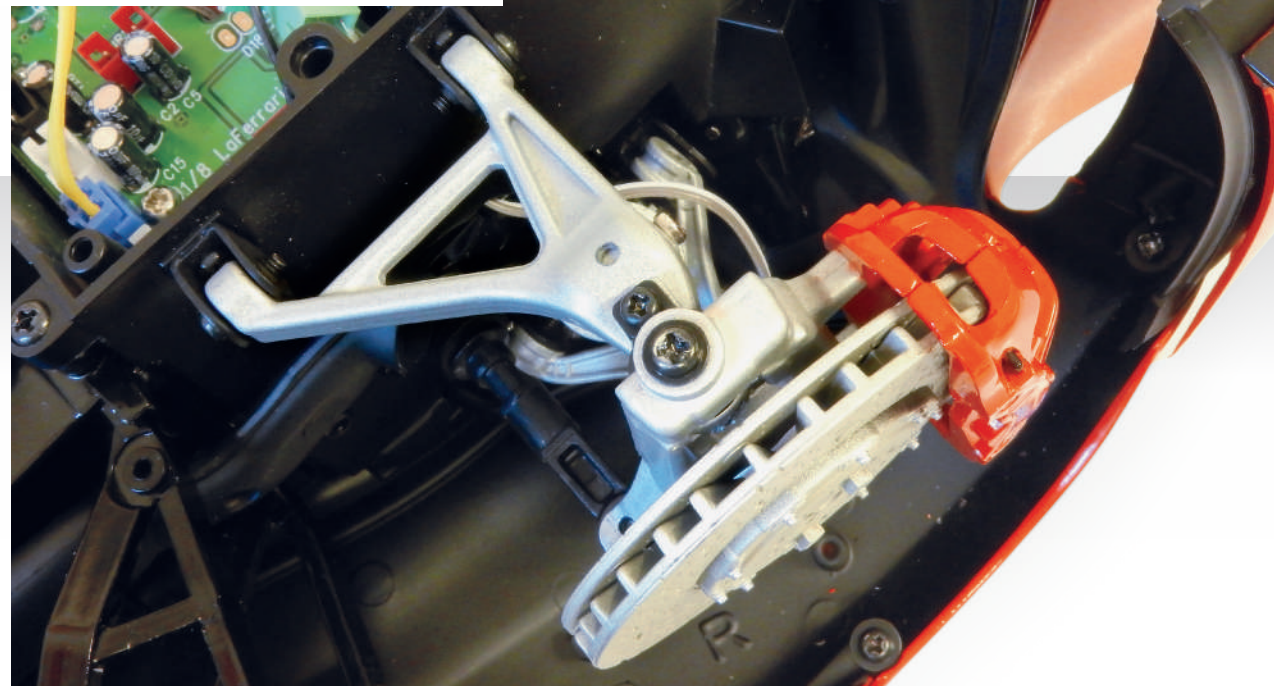

STAGE 76 THE FRONT MUDGUARD MESH FRAMES

THE FRONT MUDGUARDS ARE ALSO PART OF A SOPHISTICATED EXTERNAL AIR INTAKE SYSTEM, DESIGNED TO ACHIEVE THE NECESSARY COOLING OF THE INTERNAL COMPONENTS

PARTS LIST

NO.	PART	QUANTITY	MATERIAL
1	Front right mudguard mesh frame	1	ABS
2	Front left mudguard mesh frame	1	ABS
3	Screw type K	4	Metal



STEP 1

Fit the mesh (from stage 74) in place followed by the front left mudguard mesh frame (2).

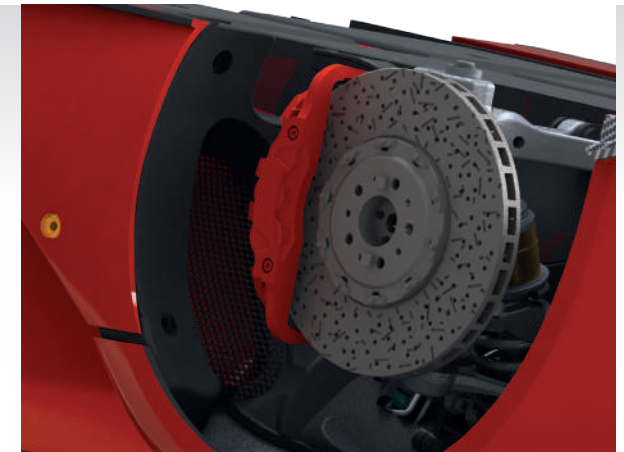
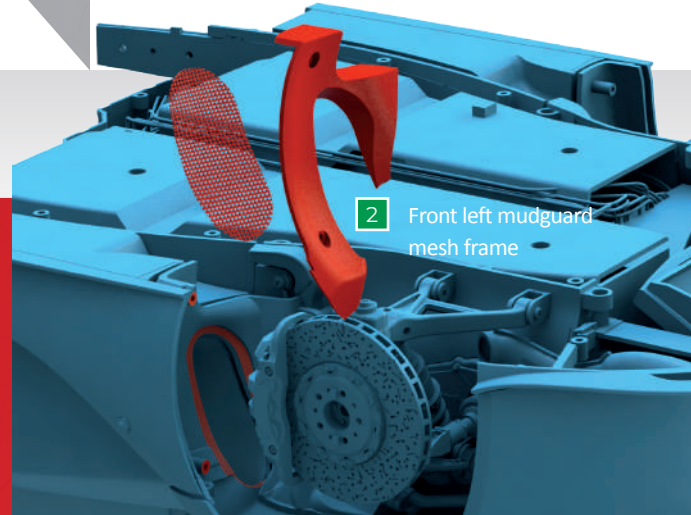

STEP 2

Secure the frame using two type K screws (3).

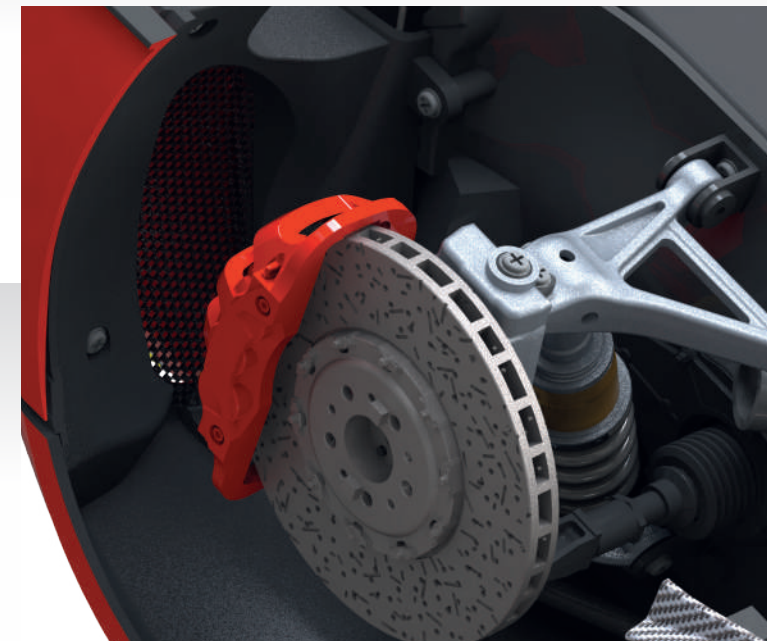
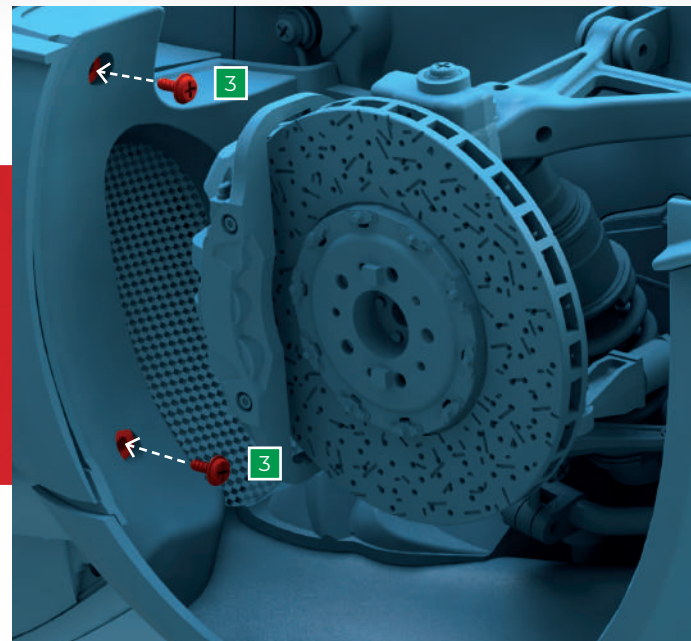

STEP 3

Fit the other mesh (stage 75) and front right mudguard mesh frame (1) in the same way, then secure with two type K screws (3).

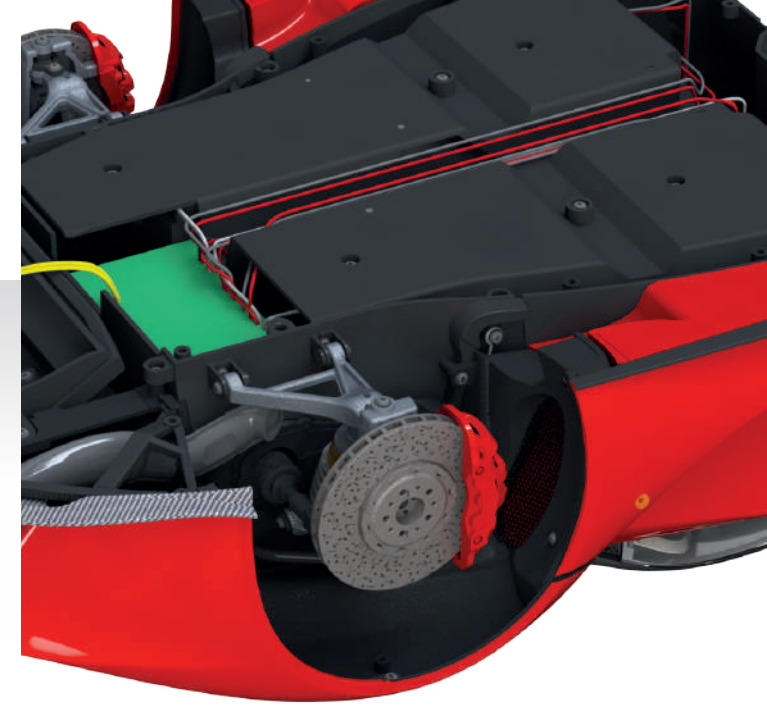
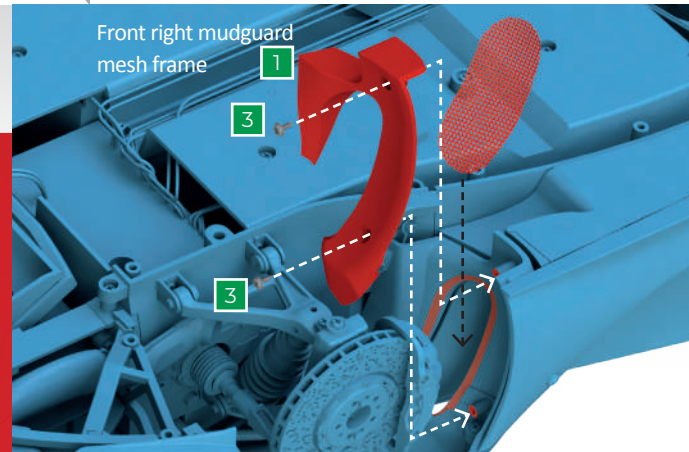

STAGE COMPLETE

The front mudguard mesh has been installed. The mudguards will be complete in a later stage, next you'll install the headlights.

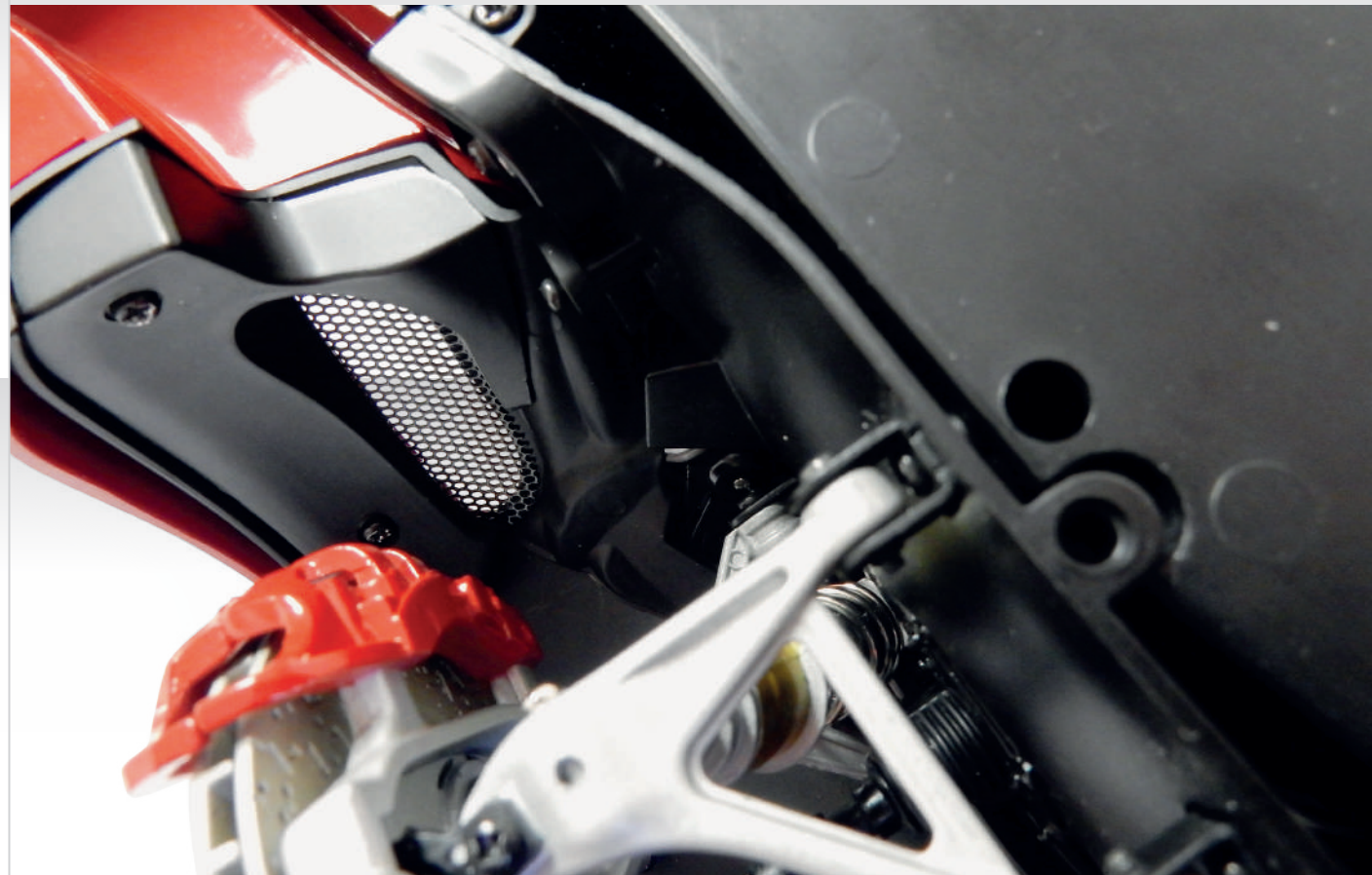

STAGE 77 THE HEADLIGHTS

ULTRA-HIGH-PERFORMANCE CARS LIKE THE LAFERRARI ARE DESIGNED TO BE DRIVEN AT THE LIMIT AT ALL TIMES. THEREFORE, WHEN DAYLIGHT FALLS, THE HEADLIGHTS MUST ENSURE MAXIMUM VISIBILITY

PARTS LIST

NO.	PART	QUANTITY	MATERIAL
1	Front right headlight	1	ABS
2	Front left headlight	1	ABS
3	Headlight LEDs	1	Varied
4	Screw type M	4	Metal

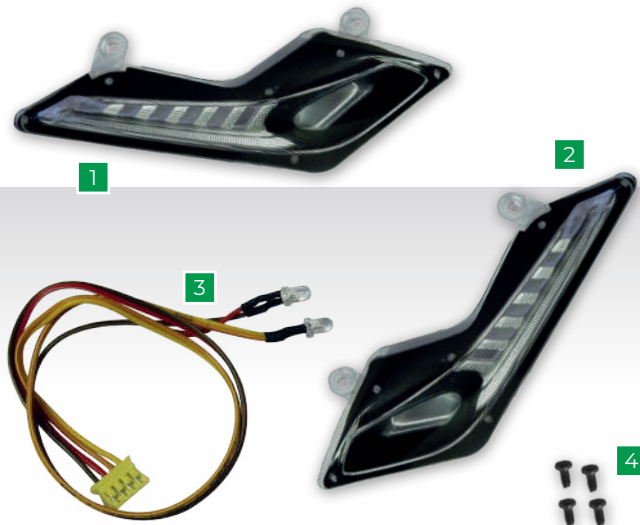

STEP 1

Plug the headlight LEDs (3) into socket G on the circuit board, then split the cables to the right and left of the model (arrows). Route the right LED through the frame then fit it into the front right headlight (1).

Front right headlight 1

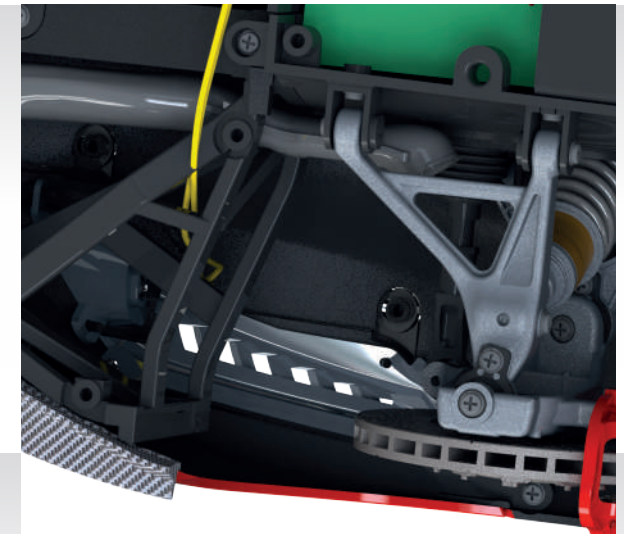
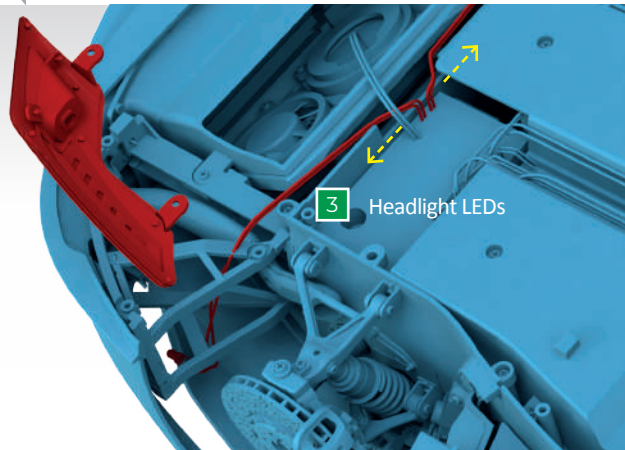

STEP 2

Fit the front right headlight and fix it in place using two type M screws (4).

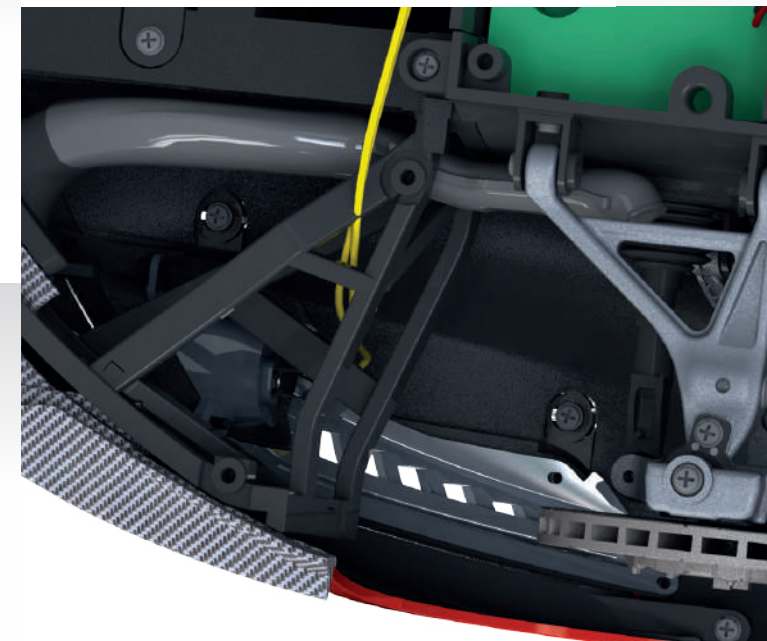
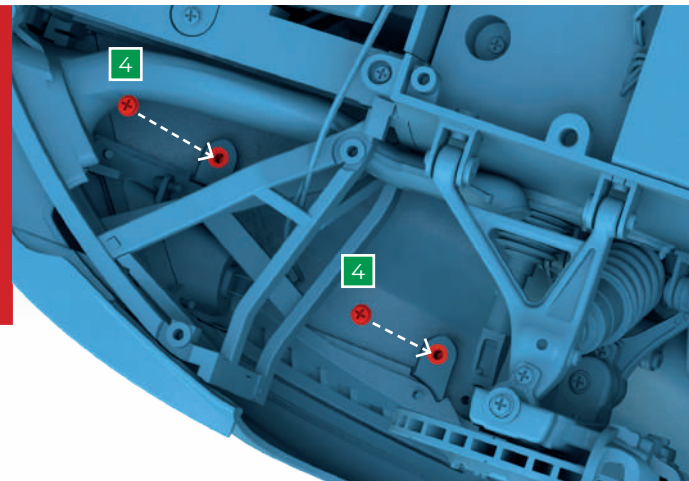

STEP 3

Fit the remaining LED (3) into the front left headlight (2) in the same way then fit in place. Secure with two type M screws (4).

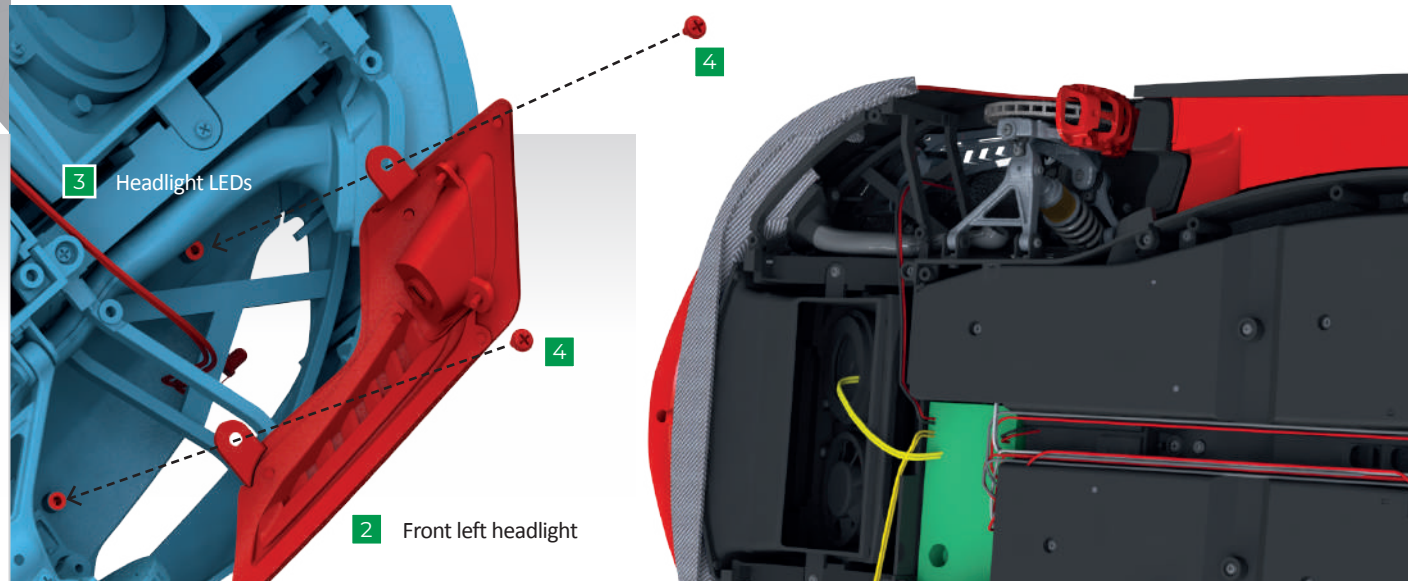

STAGE COMPLETE

With the headlights fitted onto your model, the front is now complete.



STAGE 78 THE FRONT MUDGUARDS

THE MUDGUARDS, WITH THEIR TYPICAL FINS, ARE ALSO PART OF THE AIR CIRCULATION SYSTEM THAT HELPS TO COOL THE PARTS MOST PRONE TO OVERHEATING

PARTS LIST

NO.	PART	QUANTITY	MATERIAL
1	Front right mudguard	1	ABS
2	Front left mudguard	1	ABS
3	Screw type AA	2	Metal
4	Screw type P	2	Metal
5	Screw type M	2	Metal



STEP 1

Place the front right mudguard (1) in position so that the three fixing holes are aligned.

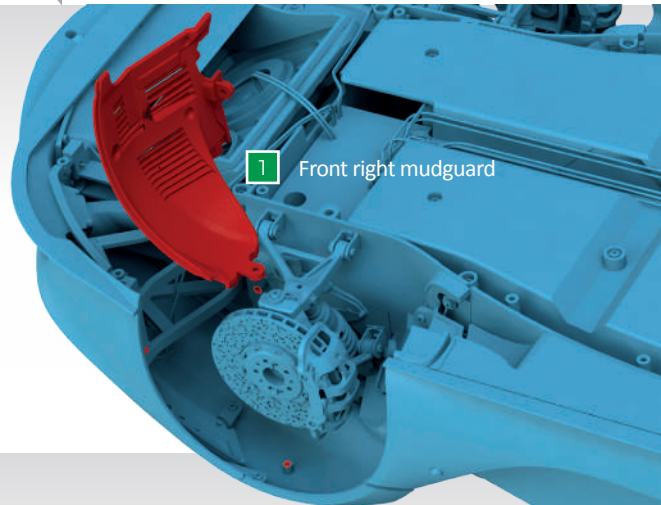

STEP 2

Each hole uses a different screw type, check the image carefully. Use a type AA (3), a type P (4) and a type M (5) to fix in place as shown.

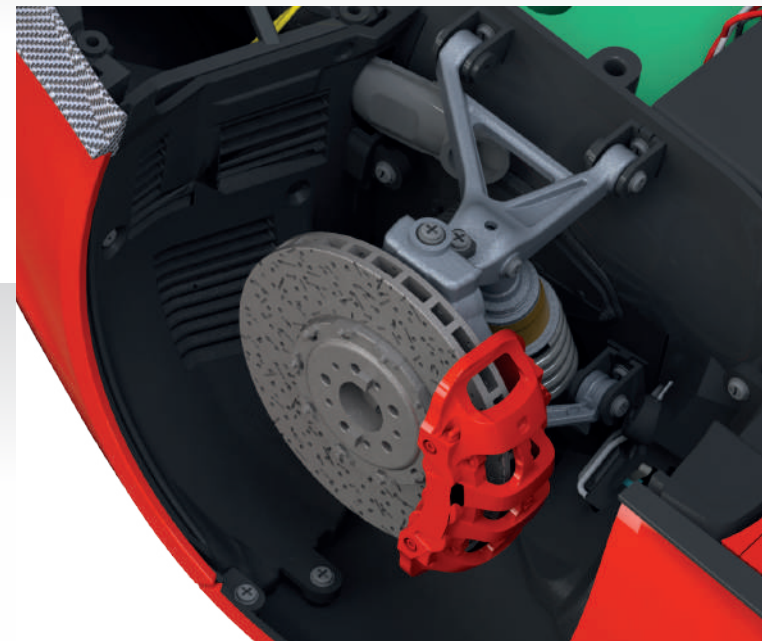
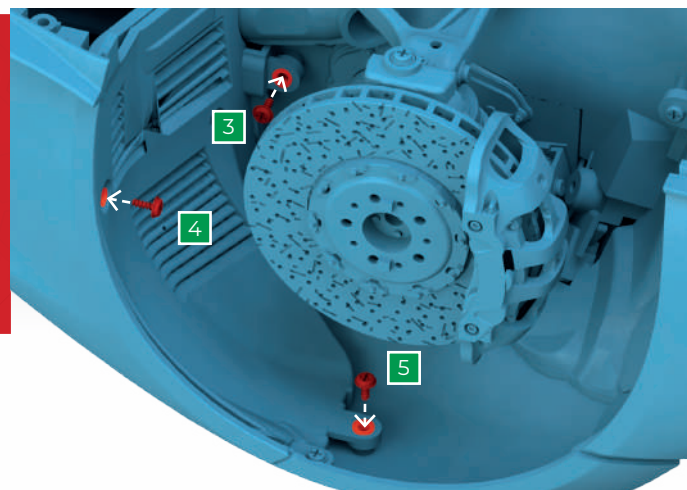

STEP 3

Fit the front left mudguard (2) and secure it using a type AA (3), a type P (4) and a type M screw (5) in the same way.

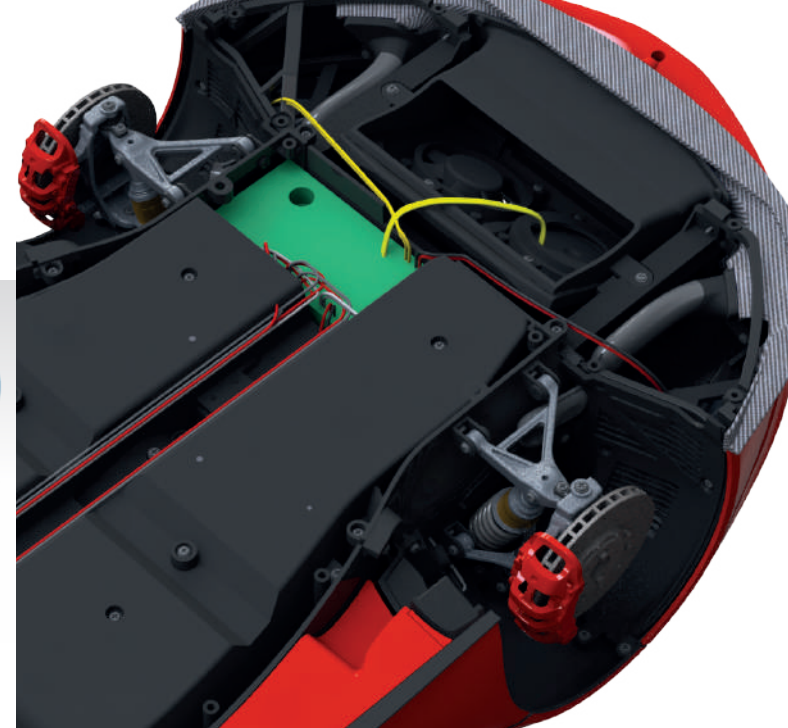
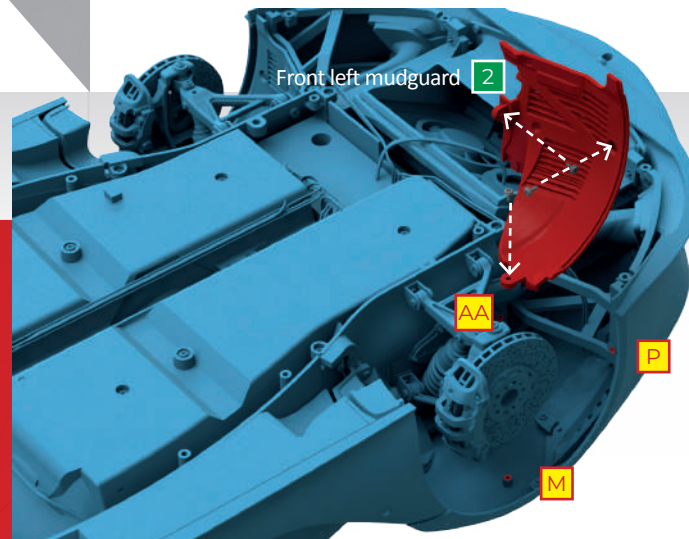

STAGE COMPLETE

The assembly of the front wheel arches of your 1:8 scale LaFerrari has been finished.

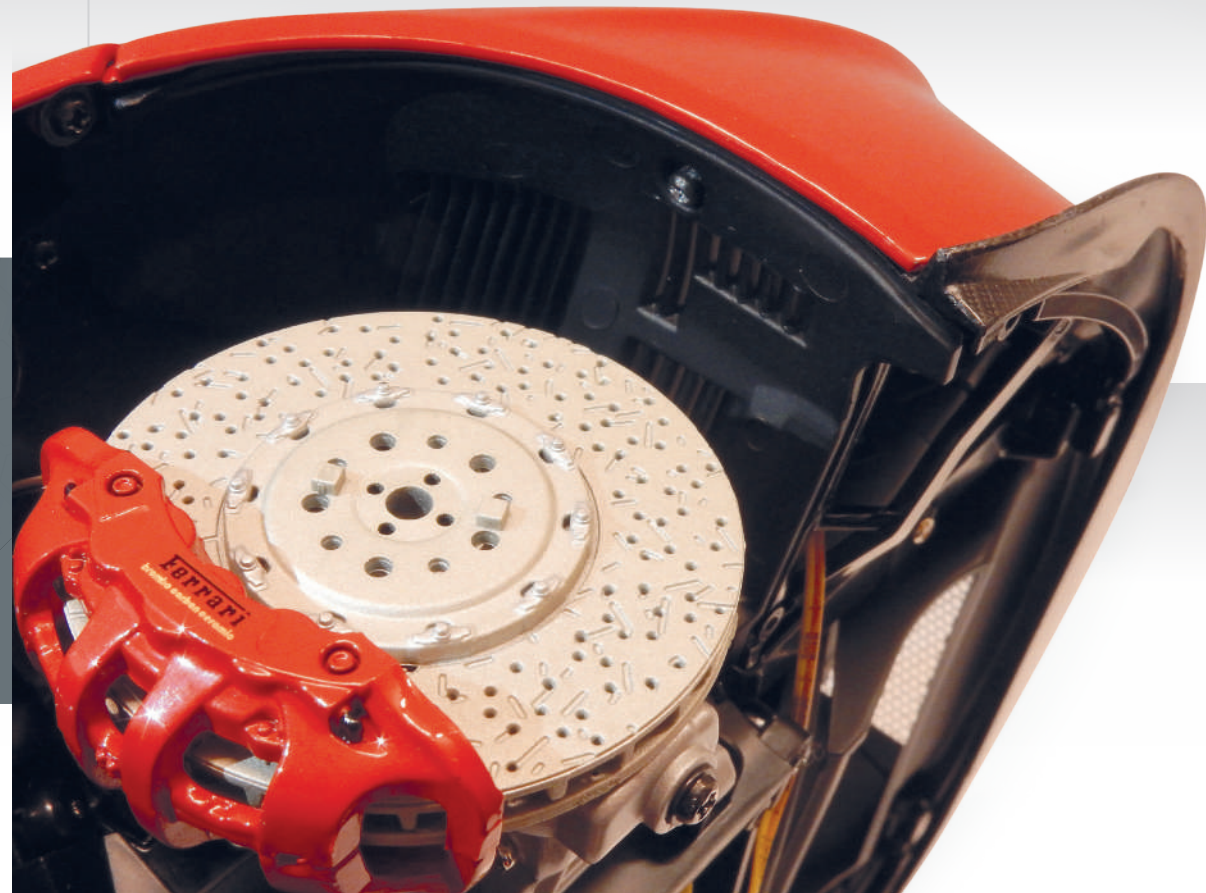

STAGE 79 THE TAIL

LIKE ALL OTHER BODY PARTS, THE TAIL OF THE LAFERRARI, WHICH FEATURES RED PAINTED SURFACES AND OTHERS IN CARBON FIBRE, HOUSES AND SUPPORTS THE AIR FLOW

PARTS LIST

NO.	PART	QUANTITY	MATERIAL
1	Grille frame	2	ABS
2	Grille	2	Metal
3	Tail	1	Varied
4	Ferrari emblem	1	ABS
5	Screw type H	8	Metal

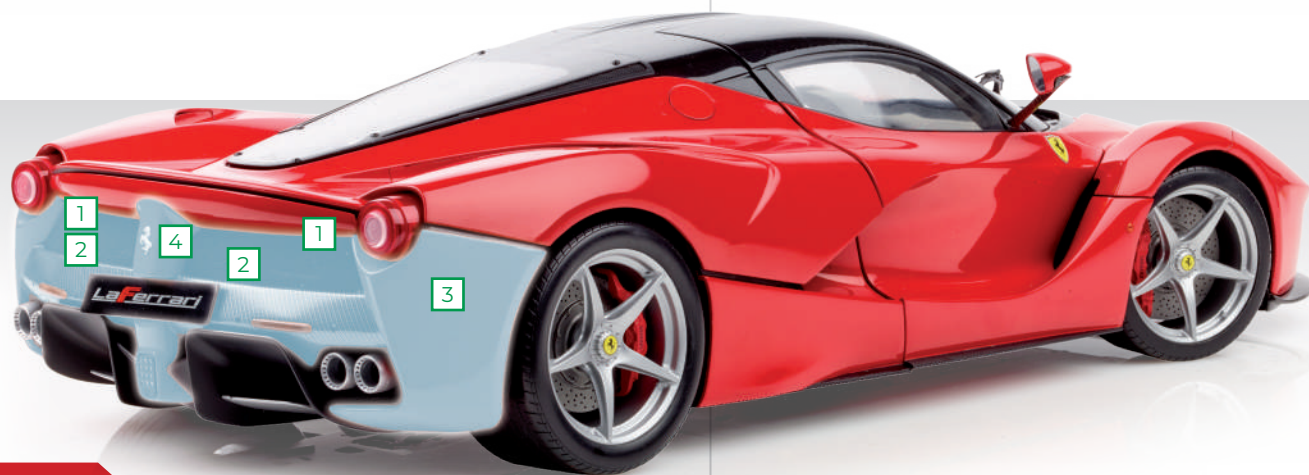
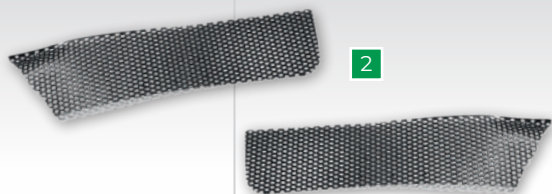

STEP 1

Note the grilles and frames are differently shaped. Use the image to help identify the right grille (2), then place it in position on the tail (3). Hold it in place by fitting the matching grille frame (1).

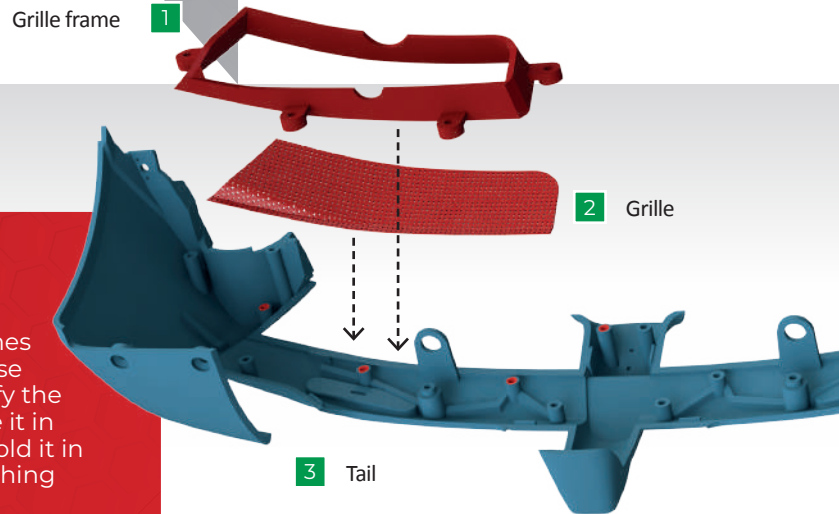

STEP 2

Fix the right grille and frame using four type H screws (5).

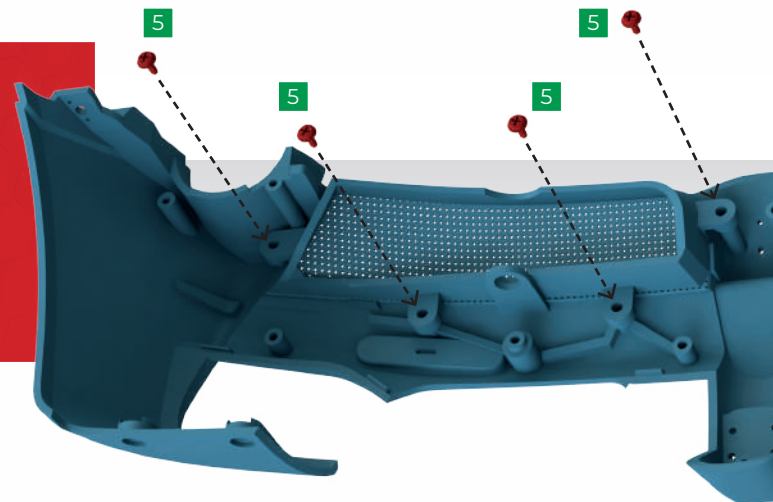

STEP 3

Fit the left grille (2) in place along with the remaining grille frame (1). Secure using four type H screws (5).

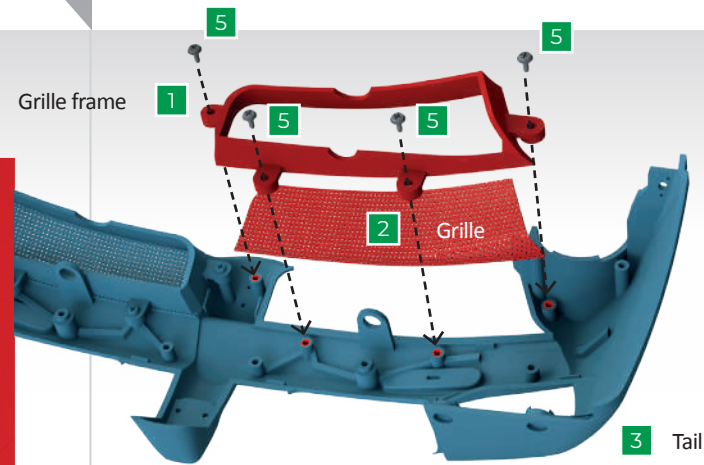

STAGE COMPLETE

Assembly on the tail for LaFerrari has begun. Keep the Ferrari emblem in a safe place until it is needed later.



STAGE 80 THE DIFFUSER TUNNELS

LAFERRARI, LIKE OTHER CARS IN ITS CLASS, HAS AN EXTRACTOR CHUTE. BY DIRECTING AIR INTO THE LOWER PART OF THE VEHICLE, IT GENERATES A DOWNFORCE THAT INCREASES GRIP ON THE GROUND

PARTS LIST

NO.	PART	QUANTITY	MATERIAL
1	Central diffuser part	1	ABS
2	Right diffuser part	1	ABS
3	Left diffuser part	1	ABS
4	Screw type X	2	Metal
5	Screw type P	4	Metal



STEP 1

Join the central (1) and left (3) diffuser parts together and fix using two type P screws (5).

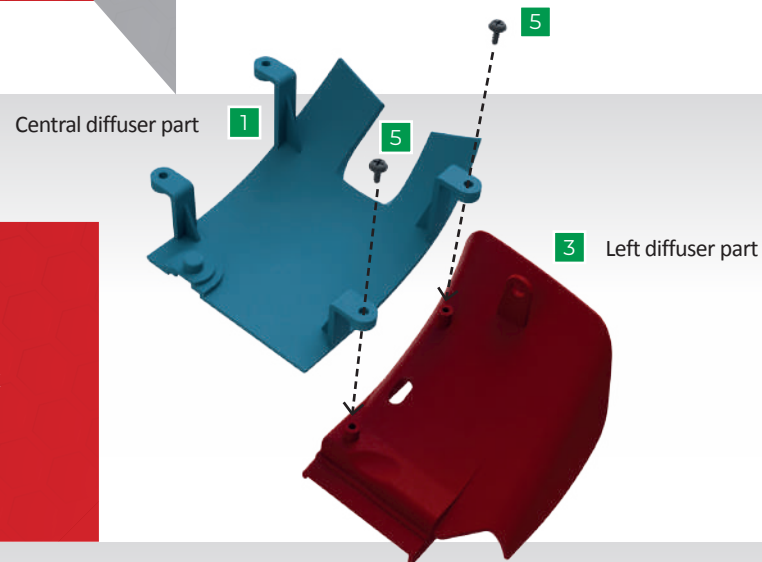

STEP 2

Fit the right (2) diffuser part onto the assembly and secure using two type P screws (5).

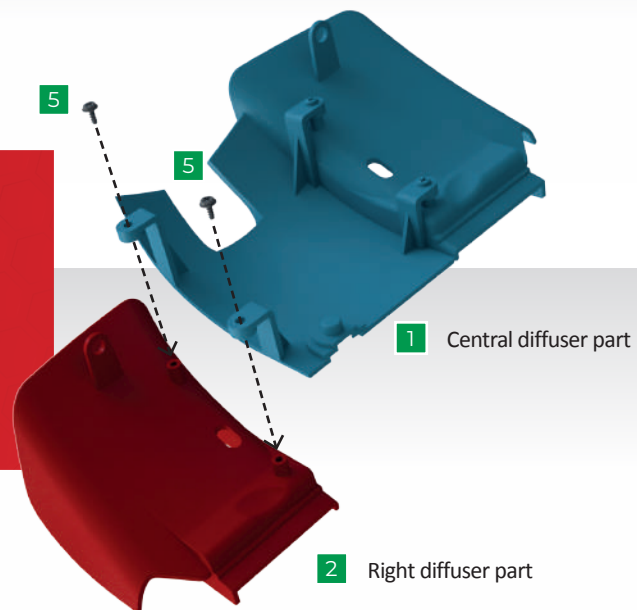

STEP 3

Fit the diffuser assembly onto the tail as shown then fix in place with two type X screws (4).

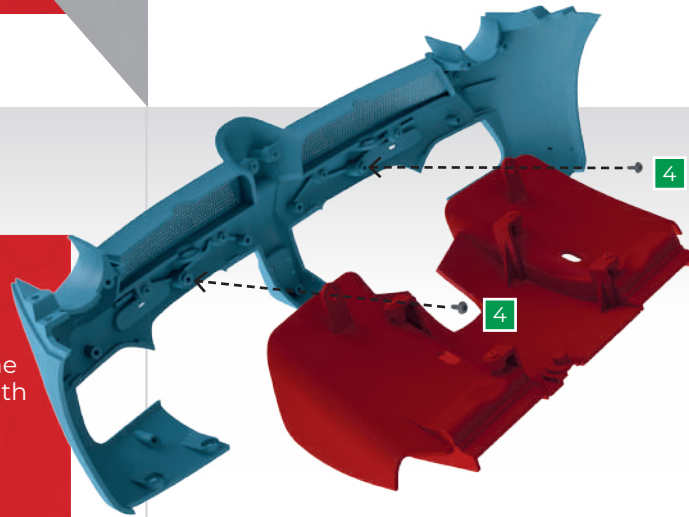

STAGE COMPLETE

Check the diffuser has been correctly fitted to the tail using the image opposite. Store the parts away safely until they are needed again.

