

**NO
TIME
TO
DIE** *007[™]*

DB5



Pack 06

BUILD INSTRUCTIONS

**STAGE 039VB: BUILDING A
REAR WHEEL RIM
(EASY-BUILD)**

**STAGE 039: BUILDING
THE OUTER WHEEL RIM
(REGULAR)**

**STAGE 040: BUILDING
THE INNER WHEEL RIM
(REGULAR)**

**STAGE 041: FITTING THE
TYRE AND TYRE SLASHER**

**STAGE 042: INSTALLING THE
EXHAUST PIPES**

**STAGE 043: DETAILING THE
COCKPIT FLOOR**

**STAGE 044: ASSEMBLING
THE GADGET CONTROL
PANEL**

**STAGE 045: FITTING THE
CIRCUIT BOARD AND WIRES**

**STAGE 046: PREPARING THE
DRIVER SEAT BASE**

**STAGE 047: ASSEMBLING
AND FITTING THE DRIVER
SEAT**

NO TIME TO DIE © Danjaq, LLC and Metro-Goldwyn-Mayer Studios Inc. NO TIME TO DIE, *007[™]* and related James Bond Indicia © 1962-2024 Danjaq, LLC and Metro-Goldwyn-Mayer Studios Inc. NO TIME TO DIE, *007[™]* and related James Bond Trademarks are trademarks of Danjaq, LLC. All Rights Reserved.



Aston Martin, the Aston Martin Wings logo and the model name "DB5" are trademarks owned, licensed or used by Aston Martin Lagonda Limited. All Rights Reserved.

Advice from the experts

Spare screws are included with each part. Occasionally, you may be instructed to keep spare or unused screws for a later stage. Keep these spares in a safe place and label them correctly.

Please make sure you don't mix up the screws. They look quite similar, but the threads do vary slightly. Using the wrong screws may damage the parts.

When securing parts together using multiple screws, fit each screw loosely to ensure all the parts are correctly aligned before gently tightening them firmly, but not overtight, in the order in which you placed them.

The screwdriver can be magnetized by stroking it with a magnet (fridge magnet, etc.) enabling it to hold the screws and make assembly easier.

If a screw is tight going into a metal part, do not force it as you may shear the head off. Remove it and put a tiny smear of Vaseline, soap or light oil on the thread. That will lubricate it and make it easier to drive home.

During the course of this build, you will receive many pieces that you will assemble immediately – following the instructions in the corresponding stage – and other pieces that you should store safely to one side, for use in future assembly stages.

Left and Right! When building your *No Time To Die* Aston Martin DB5, the left- or right-hand side refers to that side as if you are sitting in the car.



WARNING: Some parts are assembled using magnets. These magnets can cause serious injury if they are swallowed. Keep away from children. If you suspect a magnet has been swallowed, seek medical help straight away.

Stage 039VB: Building the Rear Wheel Rim (Easy-Build)

This stage is the easy-build version of the wheel rim. If you choose to use this version, move straight to Stage 041 after completing it.



STAGE 039VB PARTS LIST

Name	Name
39VB-A Outer spokes	39VB-H Spoke retainer ring
39VB-B Inner wheel rim	39VB-I Wheel hub front
39VB-C Outer ring	39VB-J Rear wheel mount
39VB-D Inner spokes	PS02 screws x9
39VB-E Outer wheel rim	PS03 screws x4
39VB-F Wheel hub back	PS32 screws x7
39VB-G Inner ring	



Stage 039VB: Building the Rear Wheel Rim (Easy-Build)



1
Line up the wheel hub front (39VB-I), outer spokes (39VB-A) and outer ring (39VB-C) as shown, then position the outer ring on top of the spokes.



2
Turn the spokes over and press the pins on the wheel hub front into the smaller holes on the outer ring.



3
Secure using 3x PS03 screws.

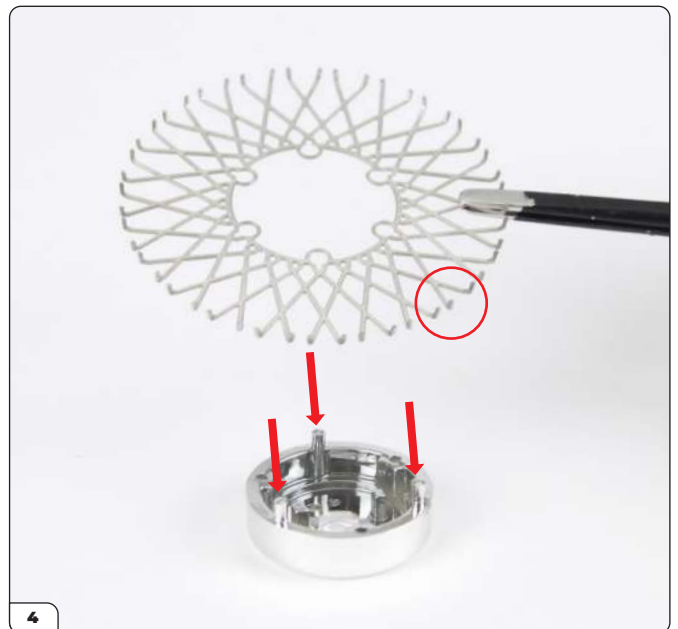

4
Place the inner spokes (39VB-D) with the ends pointing up (circled) onto the three pins on the wheel hub back (39VB-F).

Stage 039VB: Building the Rear Wheel Rim (Easy-Build)

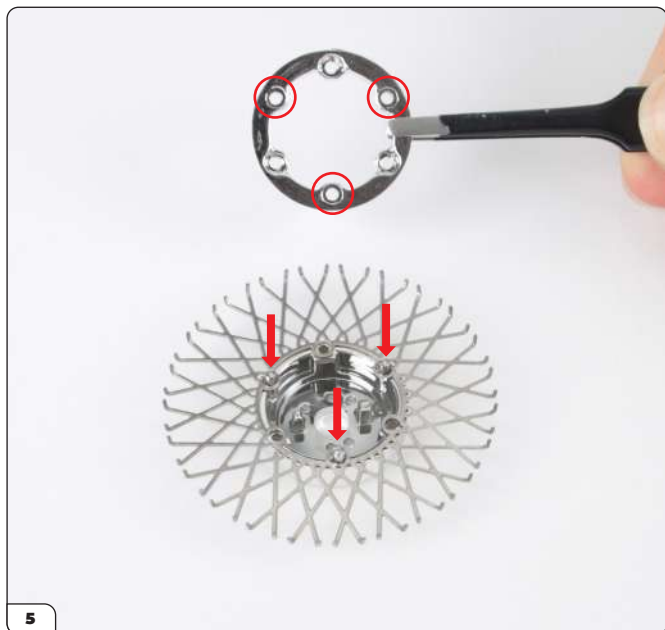

Press the inner ring (39VB-G) on top of the spokes using the three holes without a recess (circled). If any holes are covered with paint, simply poke through using a knife or needle.

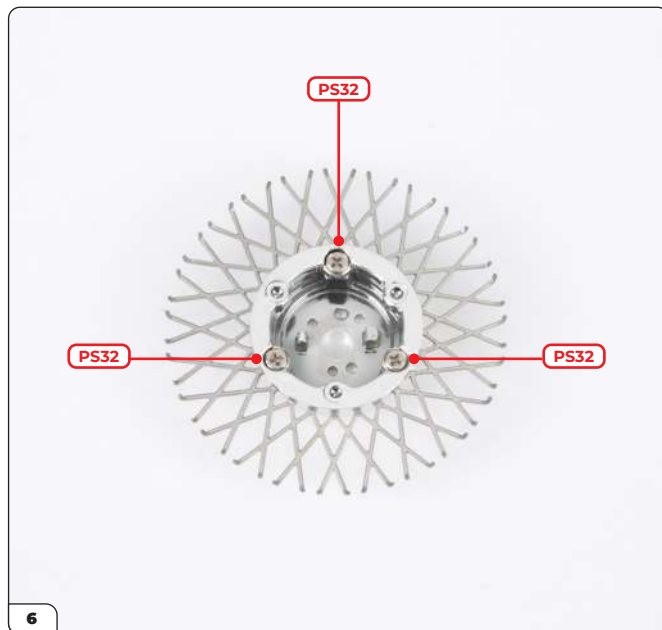

Secure using 3x PS32 screws.

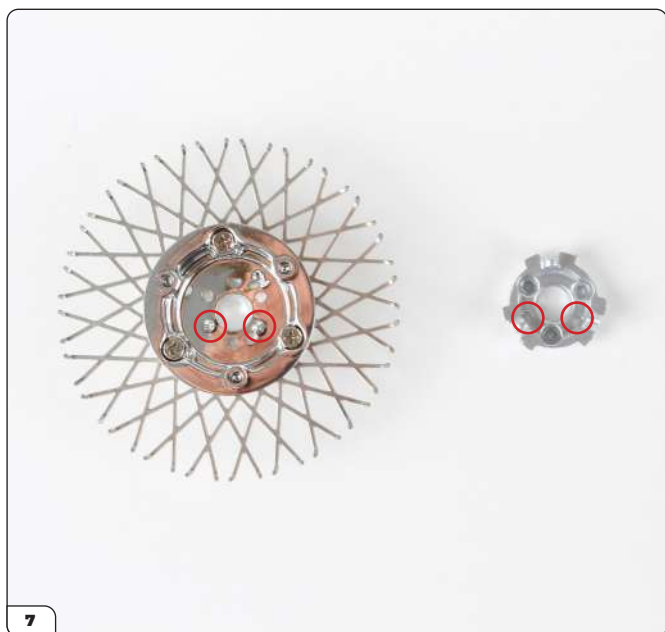

Align the rear wheel mount (39VB-J) holes with the wheel hub back pins as shown (circled).

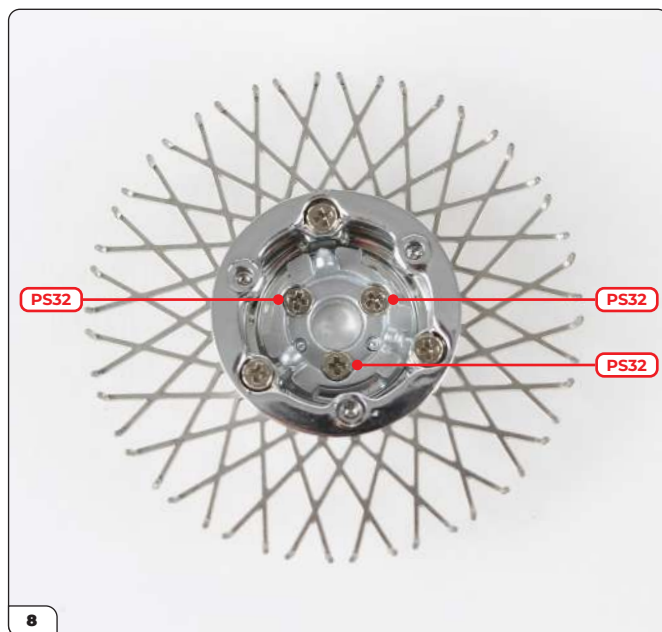

Fit the mount and secure using 3x PS32 screws.

Stage 039VB: Building the Rear Wheel Rim (Easy-Build)

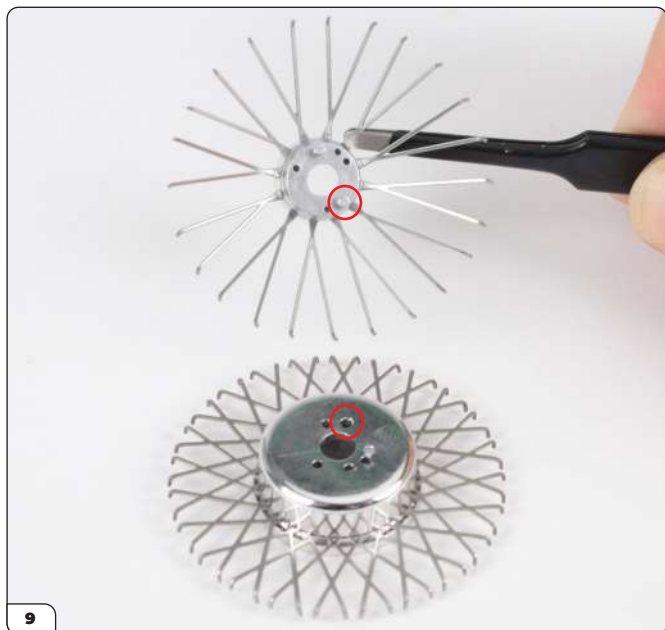

Turn the inner spokes over, then fit the outer spokes on top using the larger pin on the wheel hub front as a guide.



The ends of the outer spokes should sit in the 'V' of the inner spoke ends once in place.



Place the spoke retainer ring (39VB-H) over the assembly in the orientation shown.



Align the retainer ring so that the outer spokes fit into the recesses around the edge (inset). Check all the spokes are in place.

Stage 039VB: Building the Rear Wheel Rim (Easy-Build)

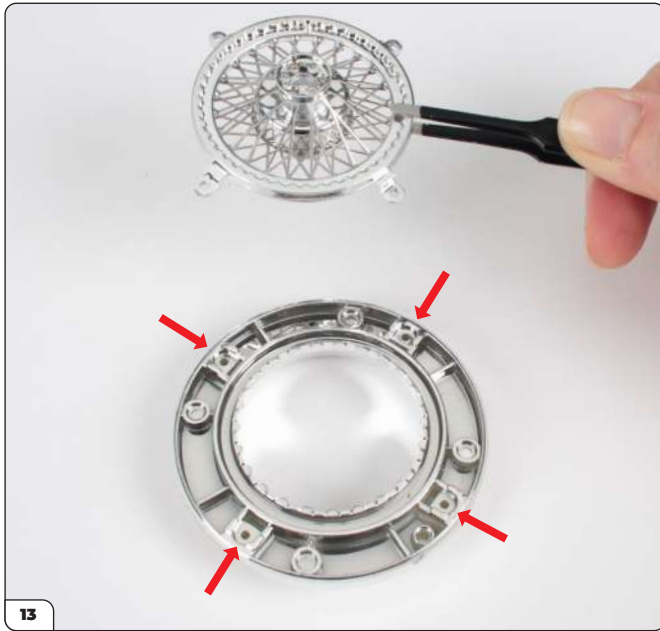

Fit the four tabs on the retainer ring into the recesses on the inner wheel rim (39VB-B).

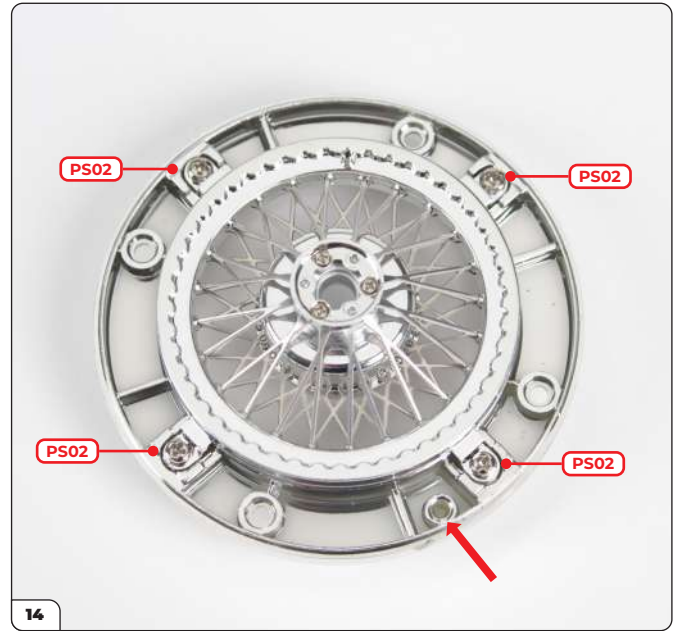

Secure using 4x PS02 screws. Note the indicated hole for the pin in the next step (arrow).

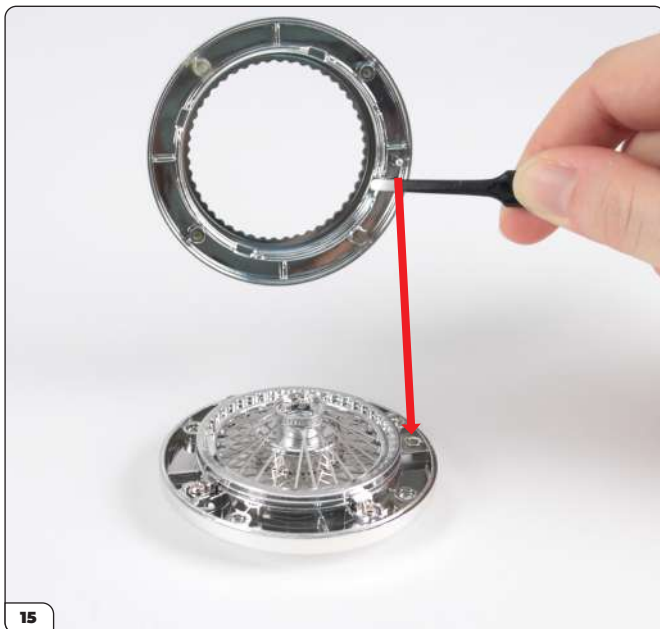

Fit the outer wheel rim (39VB-E) in place using the pin as a guide.



Press firmly around the edges.

Stage 039VB: Building the Rear Wheel Rim (Easy-Build)



Turn the assembly over and secure using 4x PS02 screws.



Stage 039: Building the Outer Wheel Rim (Regular)

This stage is for building the regular version of the wheel rims for the DB5. Go to Stage 041 if you are following the easy-build instructions.

Watch our video for extra guidance here: <https://youtu.be/iJAt2nvWEQw>



STAGE 039 PARTS LIST

Name
39-A Spoke retainer ring
39-B Rear wheel centre
39-C Outer wheel rim
39-D Spokes x24
39-D Spokes x24
PS01 screws x5

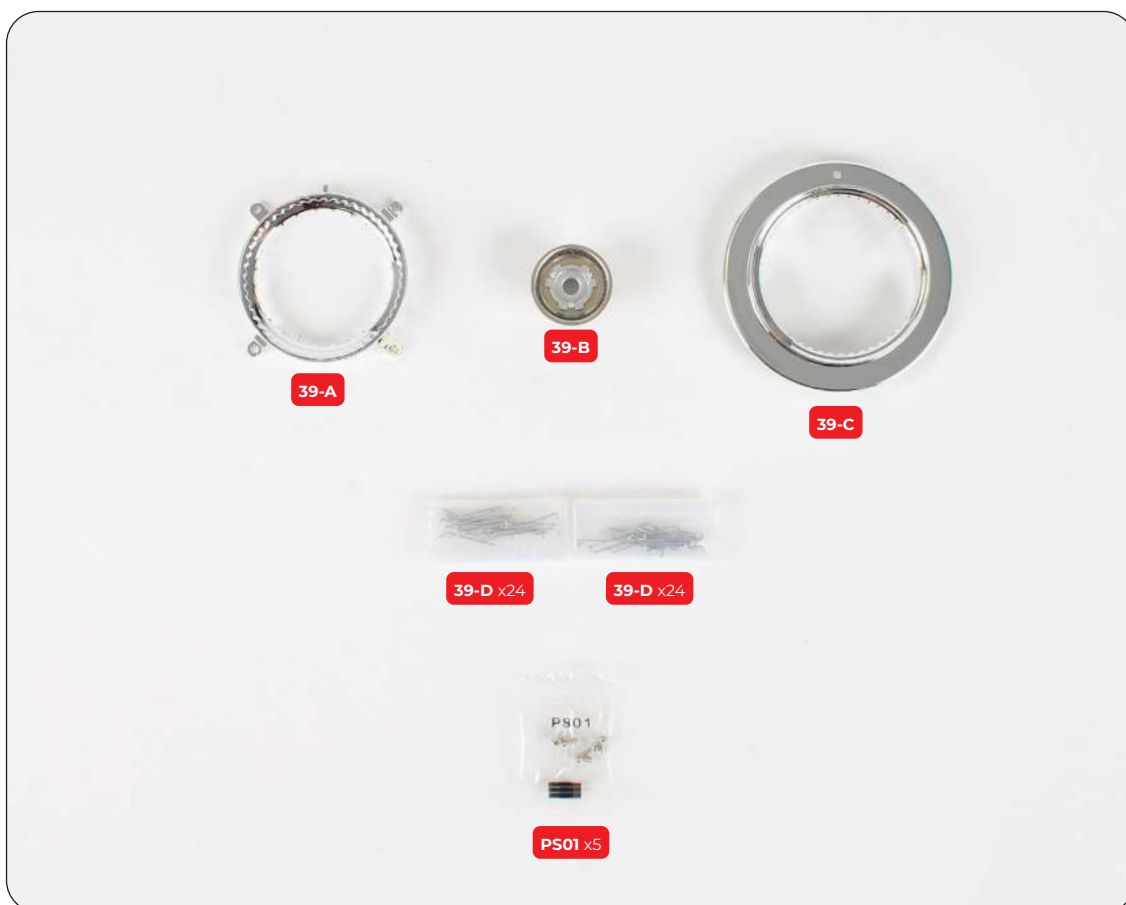

Stage 039: Building the Outer Wheel Rim (Regular)

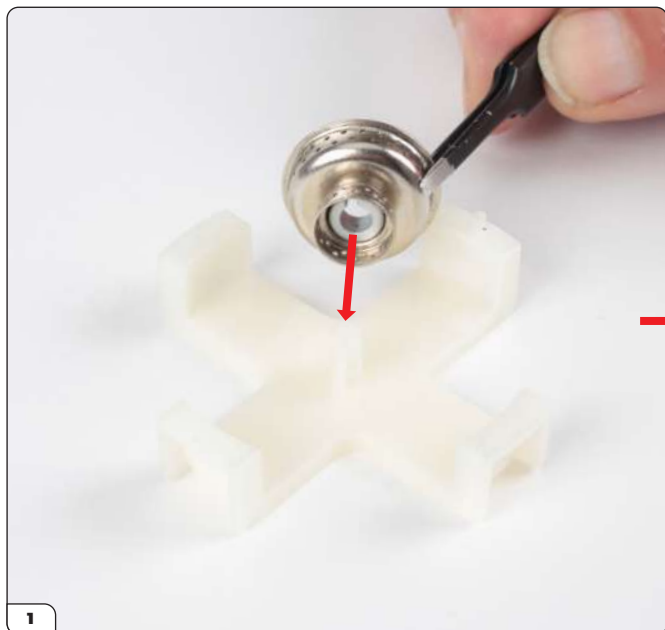

Align the shaped hole in the wheel centre (39-B) with the jig (from stage 002) then fit it in place.



Fit the outer wheel rim (39-C) onto the jig, using the pin as a guide.

Press firmly to lock the rim in position.

Stage 039: Building the Outer Wheel Rim (Regular)



Open a bag of spokes (39-D) and thread the angled tip through one of the holes of the lower row.

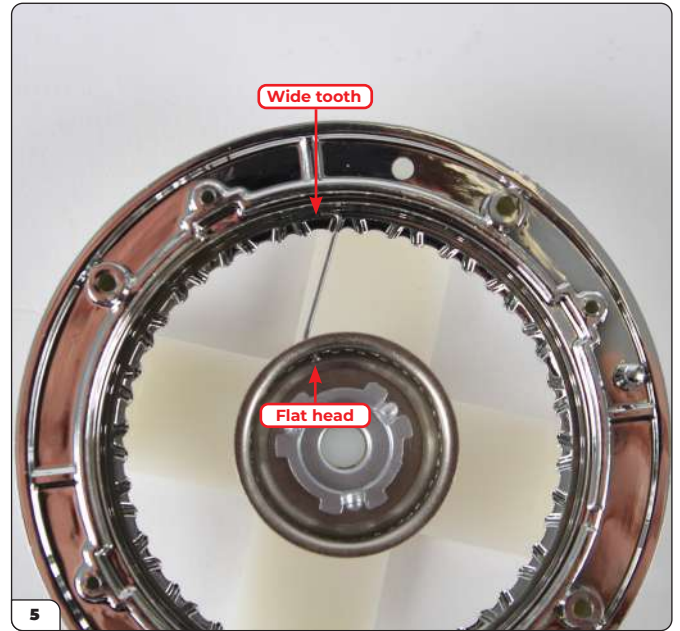

Pull the spoke through until the flat head reaches the hole, then hook the tip around the nearest wide tooth that gives a comfortable fit. The tip must face the wide tooth, as shown.



Thread another spoke through the next lower row hole and hook the tip around the next wide tooth (arrow). As you fit the remaining spokes, you can gently adjust the tension by twisting the wheel centre with your flat of your thumb.

Stage 039: Building the Outer Wheel Rim (Regular)



Continue until all 24 spokes are in position.

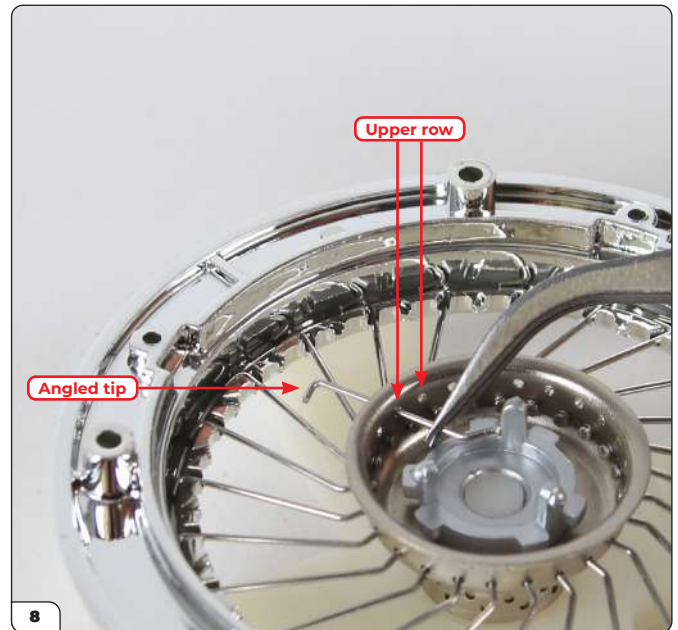

Open the remaining bag of spokes (39-D) and thread the angled tip through one of the holes in the upper row.

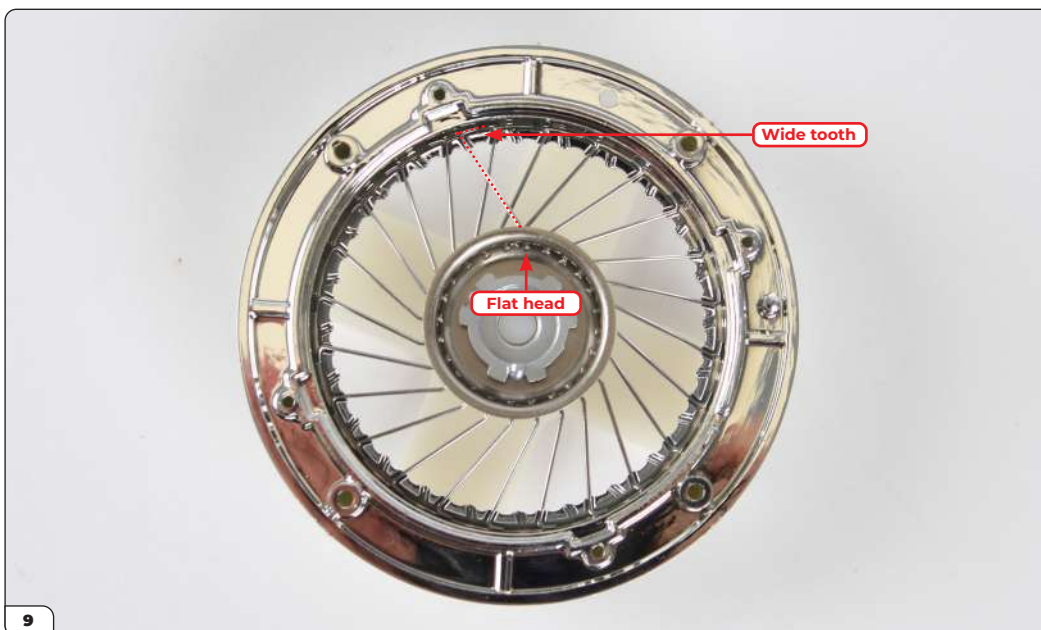

Pull the spoke through until the flat head reaches the hole, then hook the tip around the nearest wide tooth that gives a comfortable fit, facing the tip of the lower row spoke. While threading, some of the other spokes may be knocked out of position. You can wait until both rows have been threaded before correcting any tips.

Stage 039: Building the Outer Wheel Rim (Regular)



Thread another spoke through the next upper row hole and hook the tip around the next wide tooth (arrow). Note the spokes create a diamond shape, highlighted in the image.



Continue in sequence until all spokes have been fitted, then carefully check each wide tooth to ensure the spokes are in the correct position.

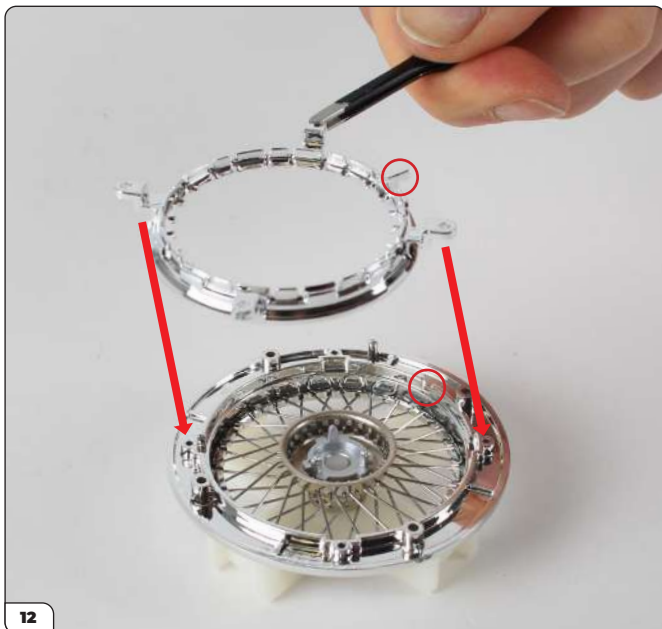

Fit the spoke retainer ring (39-A), using the protruding tab as a guide.

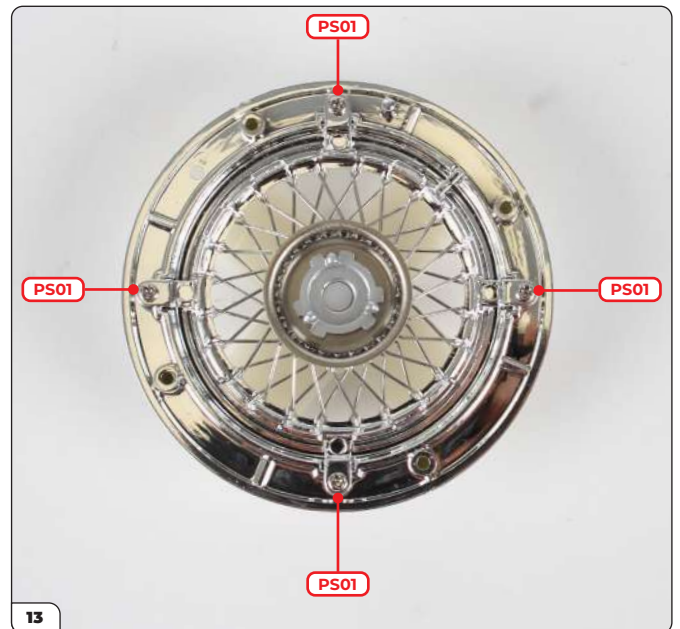

Check the spokes are in place, then secure the ring using 4x PS01 screws. To continue building, go to Stage 040.

Stage 039: Building the Outer Wheel Rim (Regular)

STAGE COMPLETE



Stage 040: Building the Inner Wheel Rim (Regular)

You'll continue to assemble the wheel by building the inner rim and its spokes then fitting it to the outer rim.



STAGE 040 PARTS LIST

Name
40-A Inner wheel rim
40-B Spacer ring
40-C Spokes type A x12
40-D Spokes type B x12
PS02 screws x5

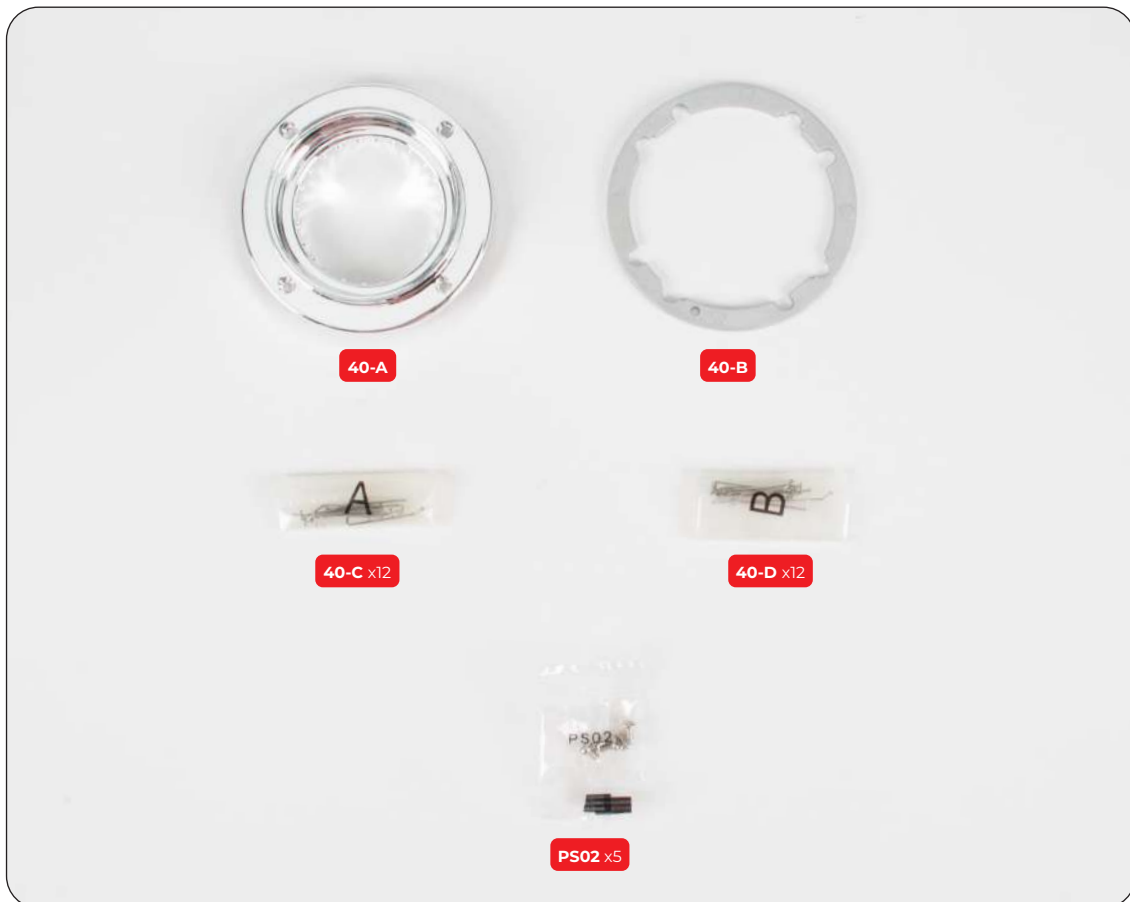

Stage 040: Building the Inner Wheel Rim (Regular)



Align the spacer ring (40-B) with the outer wheel rim assembly (Stage 039) using the hole and pin (circled) as a guide. Fit the ring in place.



Turn the assembly over and push the tip of a type A spoke (40-C) through one of the holes in the lower row.



Pull the spoke through and guide the tip into the diamond shape to the left and out through to the opposite side.

Stage 040: Building the Inner Wheel Rim (Regular)

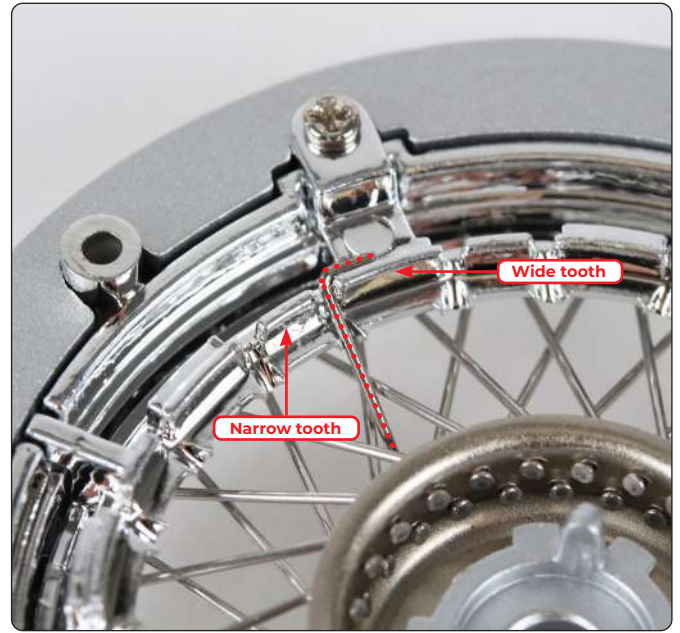

Turn the assembly over and fit the tip of the spoke. **It should hook around a wide tooth as shown.** If it aligns with a narrow tooth, thread the spoke through the next diamond along. This is very important. **Please ensure the spoke is fitted around a wide tooth.**



Once you are happy with the fit of the first spoke, thread another type A into the next lower hole and through the diamond two-along from the first, as highlighted in the image. At this stage, the tips can be left loose on the opposite side.



Continue to thread type A spokes around the lower row, pushing the tip through alternating diamonds as indicated. Continue to leave the ends loose for now, they do not need fitting onto the wide teeth yet.

Stage 040: Building the Inner Wheel Rim (Regular)



Now take a type B spoke (40-D) and thread it through a hole of the upper row. Cross it over the lower row spoke to its left (circled) and guide the tip to the empty diamond without a spoke through it (highlighted).

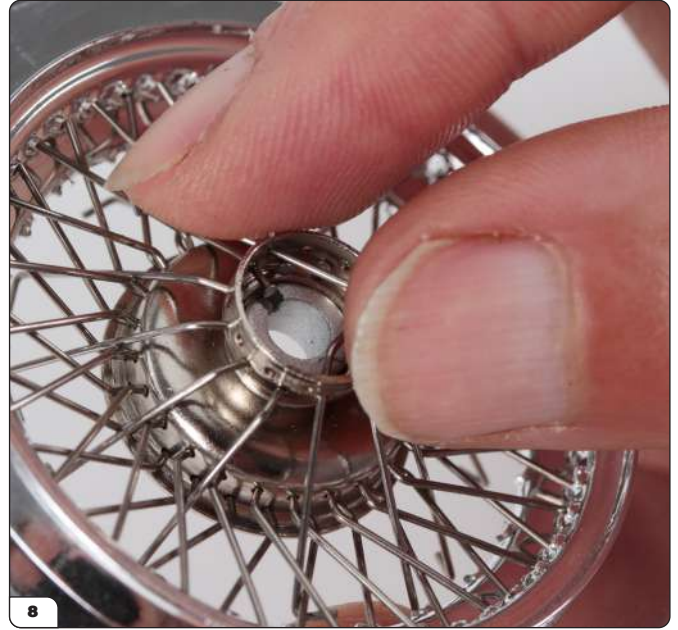

Press the tip through the diamond with your forefinger while pushing the spoke into position with your thumb as shown.



Turn the assembly over and check the tip fits over a wide tooth to face one of the lower row spokes.



Turn back over and thread another type B spoke into the next upper hole along, crossing it over the type A to its left and into the next empty diamond to the left.

Stage 040: Building the Inner Wheel Rim (Regular)

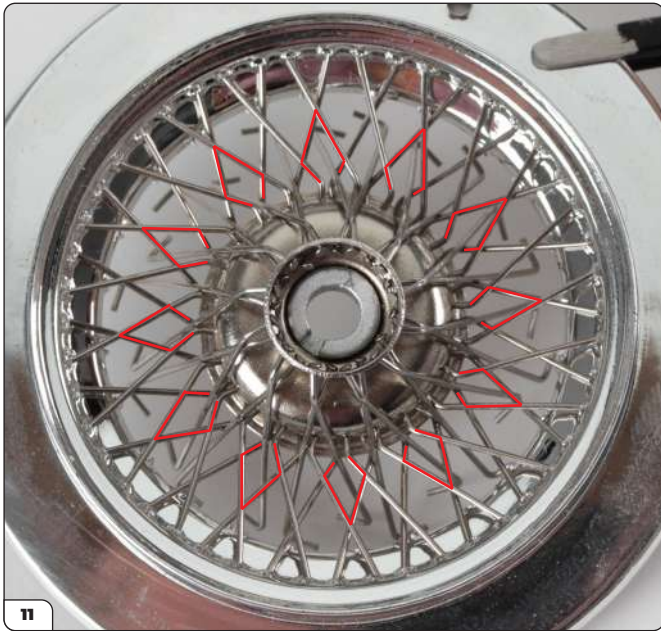

Continue to thread type B spokes through, crossing over the type A and through the next empty diamond in the same way.



Once you are happy all the spokes are fitted correctly, they can be fitted to the wide teeth. Start by pushing a piece of tissue paper into the wheel centre to hold the spokes in place.

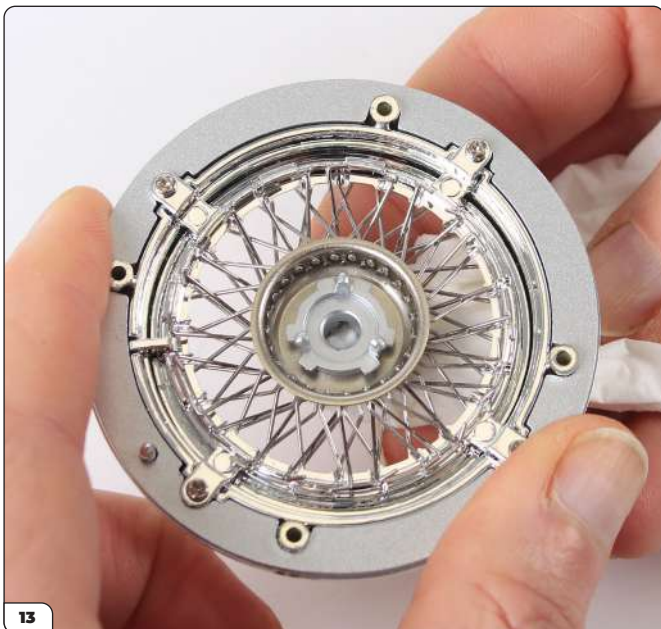

Keeping the tissue in place to hold the spokes, turn the assembly over. The tips of the spokes should now fall naturally towards the teeth.



Gently brush the spokes with your finger to hook them over the wide teeth around the edge. The tension can be adjusted by gently pushing the soft part of your thumb into the centre and carefully twisting.

Stage 040: Building the Inner Wheel Rim (Regular)

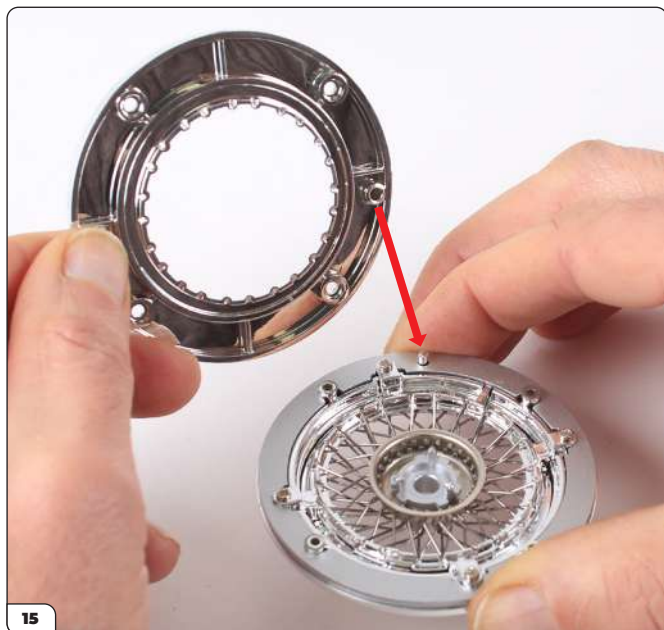

Fit the inner wheel rim (40-A) onto the assembly using the hole and pin as a guide.



Press the inner rim firmly, making sure the spokes stay in position, then secure using 4x PS02 screws.

STAGE COMPLETE



Stage 041: Fitting the Tyre and Tyre Slasher

In this stage you'll fit the tyre around the wheel rim and mount it onto the rear right hub. You'll then fit the hub cap with the deployable tyre slasher.



STAGE 041 PARTS LIST

Name
41-A Tyre
41-B Hub cap
41-C Tyre slasher

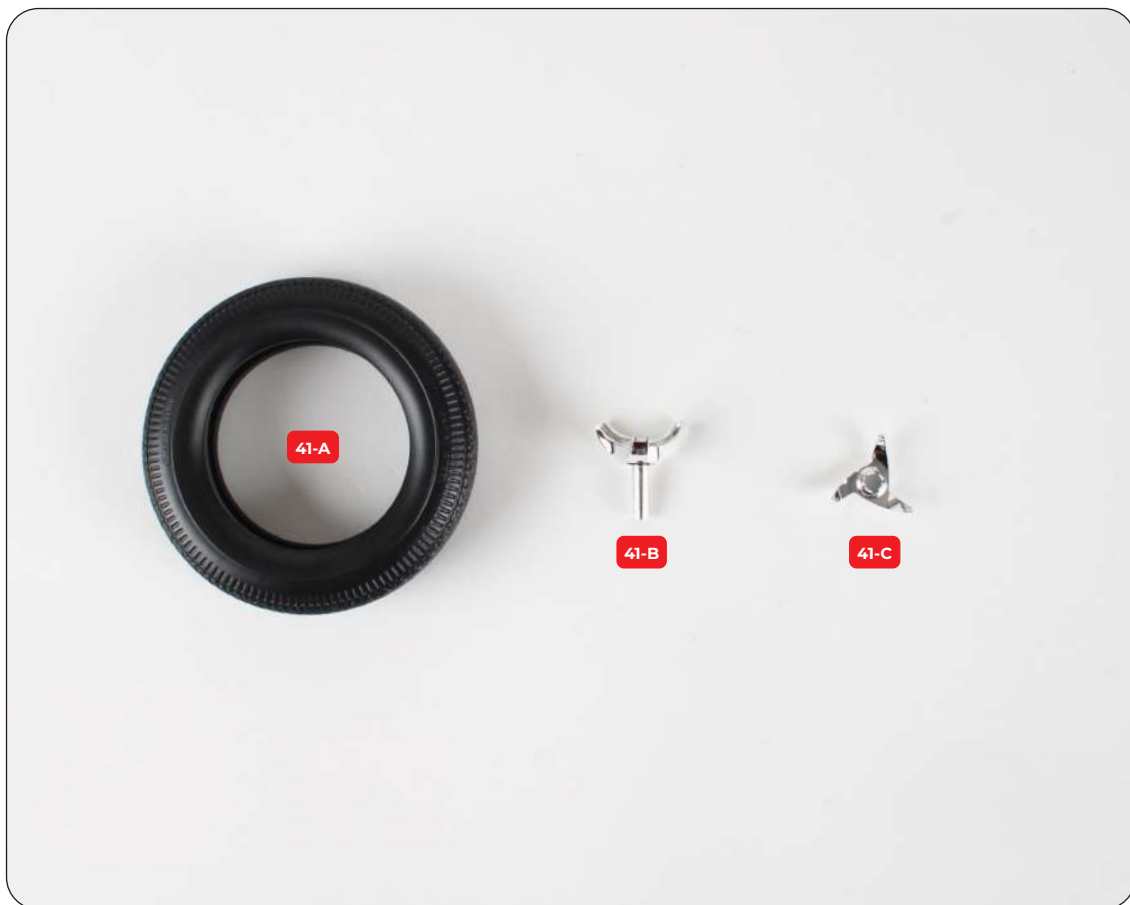

Stage 041: Fitting the Tyre and Tyre Slasher



Carefully place the tyre (41-A) in a bowl of hot water to soften it. Take care not to splash hot water when placing the tyre in the bowl.



After 1-2 minutes, remove the tyre from the water using tweezers to avoid burning your fingers. Dry with a cloth.



Fit your wheel rim (from stage 039VB or stage 040) into the tyre while it is still flexible. Press the rim into the tyre, then work your way around pulling the tyre over the rim.



Stage 041: Fitting the Tyre and Tyre Slasher



The rear wheels have a unique mount with three locking posts (circled).



The posts fit into the tabs on the rear hubs.

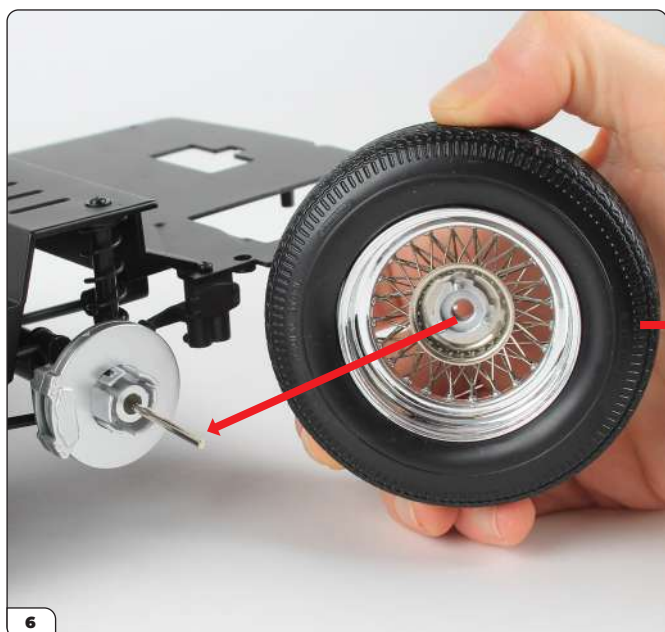

Fit the wheel onto the rear left hub, making sure the posts align with the tabs (highlighted in steps 4 and 5). Press the wheel firmly until the posts click into place.



Stage 041: Fitting the Tyre and Tyre Slasher



Fit the hub cap (41-B) over the pin in the centre of the wheel. **Do not glue** any of these parts, these tyre slashers are the 'classic' design. Later in the build you will be given the option to replace them with a slim-line version.

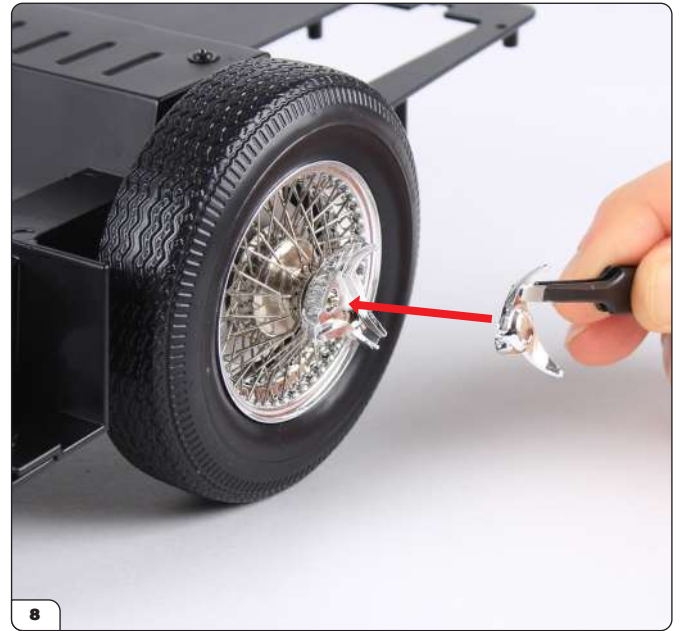

Align the tyre slasher (41-C) with the hub cap and press over the end of the pin.



The pin allows the tyre slasher to be pulled away from the hub cap and spin independently of the wheel. Grip the blades at the tips (circled) then pull away from the hub cap.

Stage 041: Fitting the Tyre and Tyre Slasher

STAGE COMPLETE



Stage 042: Installing the Exhaust Pipes

In this stage you'll install the exhaust pipes and mufflers to the underside of the chassis.



STAGE 042 PARTS LIST

Name
42-A Muffler 1
42-B Muffler 1
42-C Muffler 2
42-D Muffler 2
42-E Exhaust pipe
42-F Exhaust pipe
PS05 screw x13



Stage 042: Installing the Exhaust Pipes

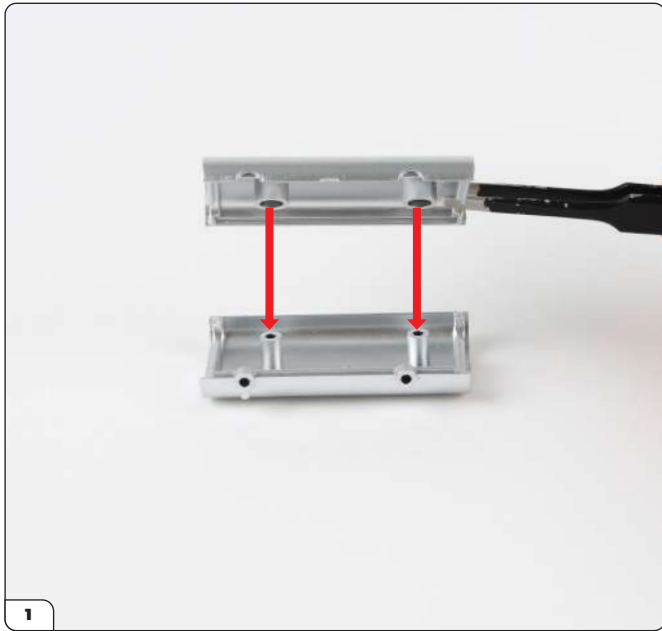

To start, take the two halves of a muffler (42-A and 42-B) and align them as shown.



Fit together using the raised screw posts. Note the shaped screw hole for fitting the muffler in step 5.

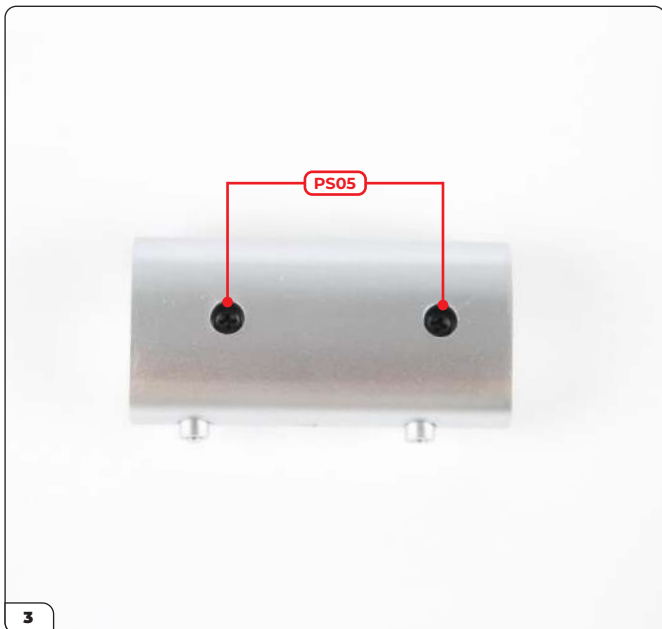

Fix together using 2x PS05 screws.

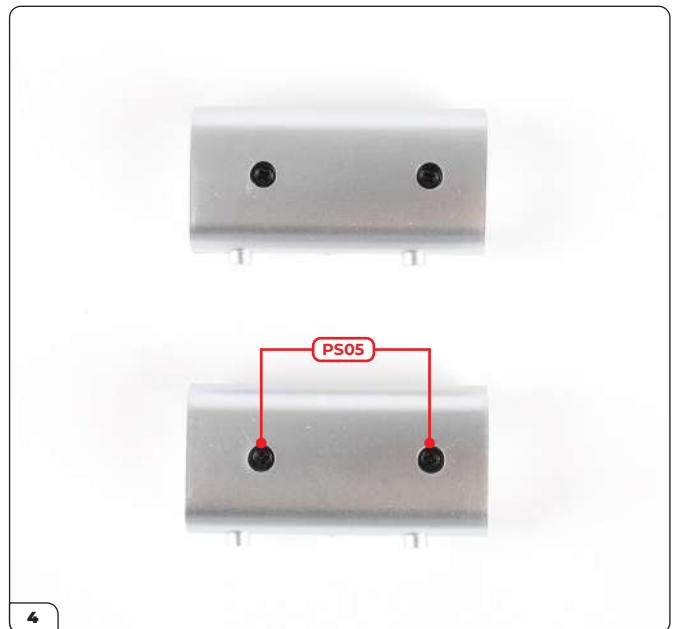

Assemble the second muffler (42C and 42D) in the same way and secure using 2x PS05 screws. The halves of the muffler are identical.

Stage 042: Installing the Exhaust Pipes

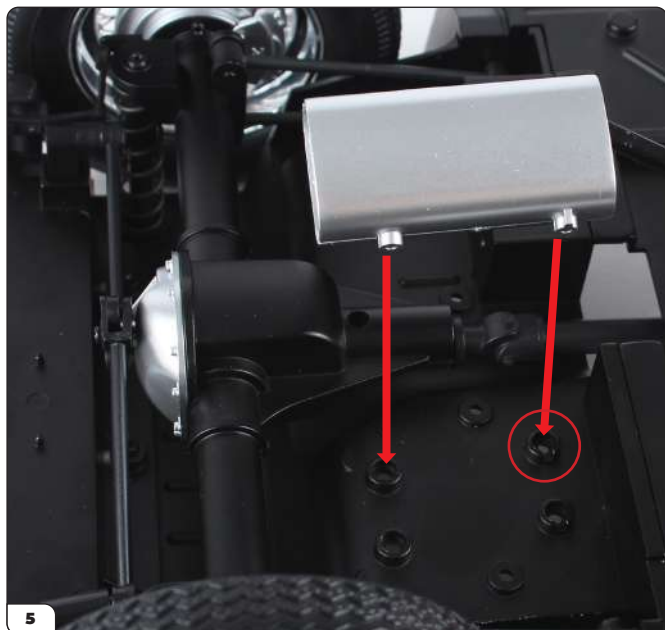

Fit one of the mufflers onto the underside of the chassis assembly using the shaped hole (circled) as a guide.

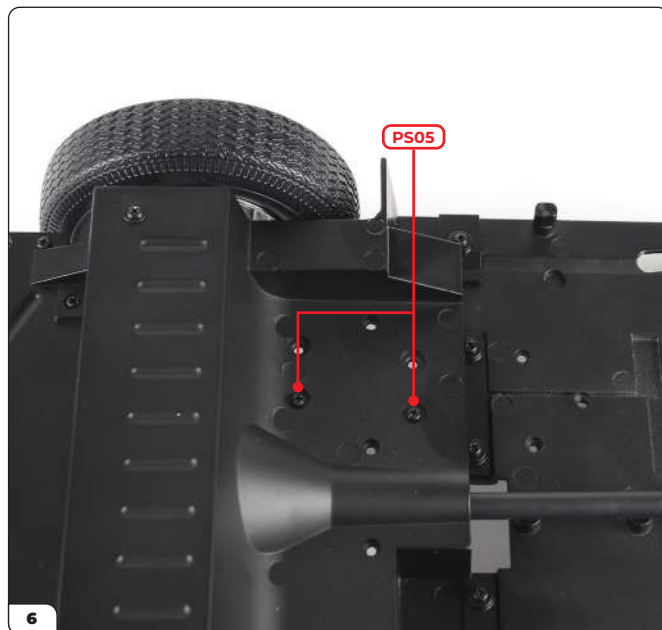

Turn the assembly over and secure using 2x PS05 screws.

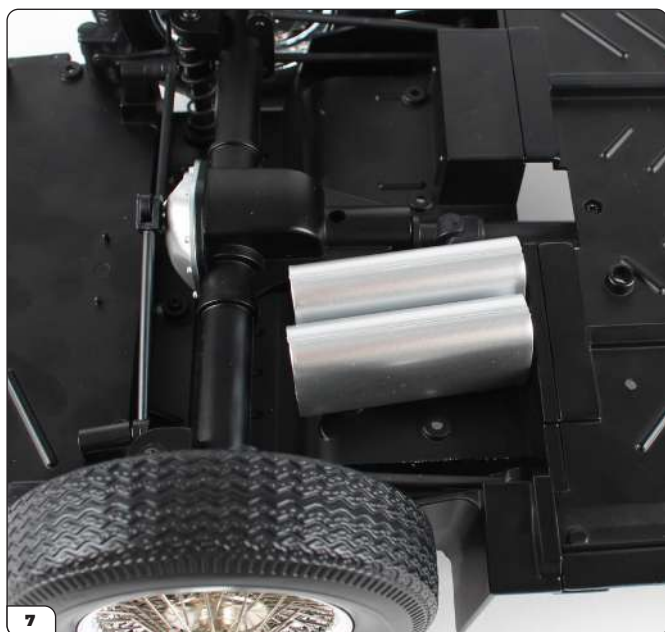

Fit the second muffler in the same way as the first one.

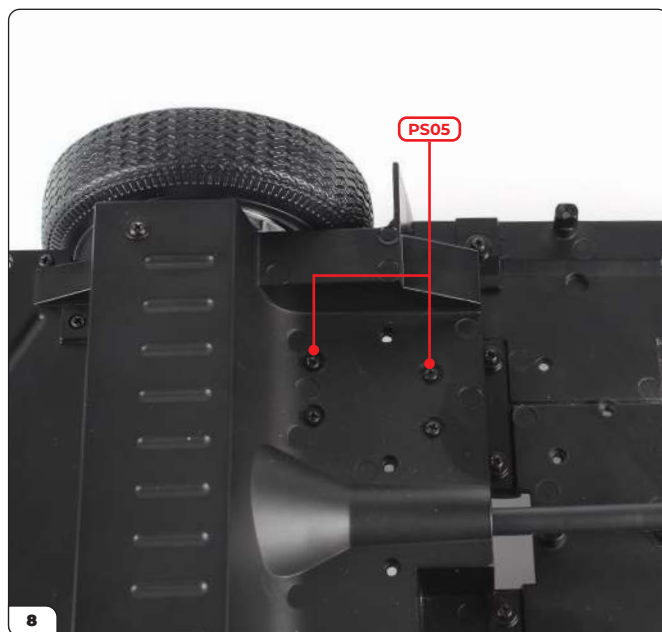

Turn over and secure with 2x PS05 screws.

Stage 042: Installing the Exhaust Pipes

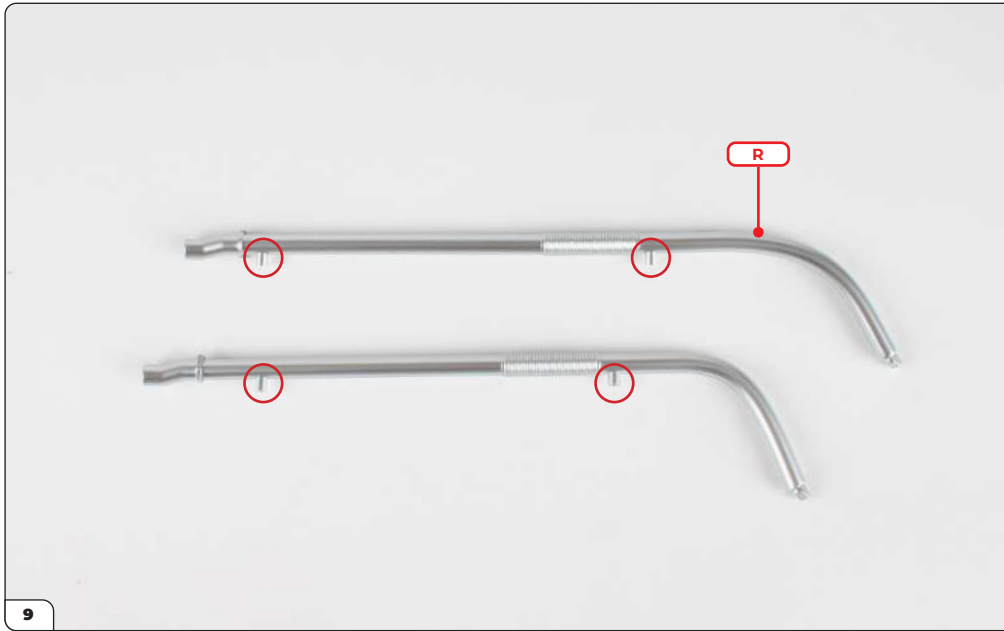

Take the two exhaust pipes. The right exhaust pipe ('R') is the longest, with the raised screw posts spaced further apart.

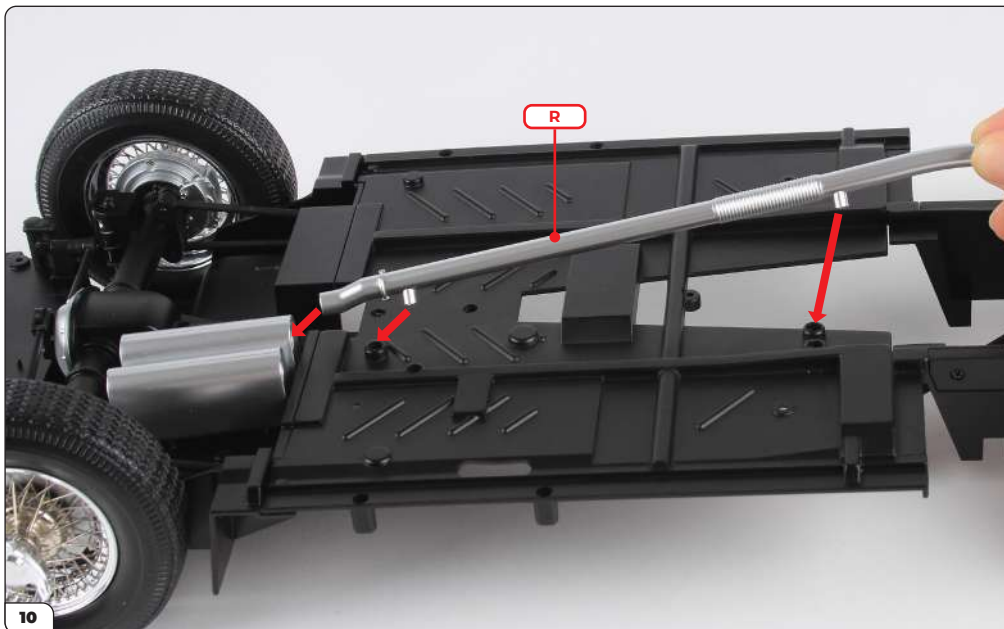

Fit the angled end of the right exhaust pipe into the first muffler. At the same time, fit the screw posts into the raised holes on the chassis.

Stage 042: Installing the Exhaust Pipes



The right exhaust pipe should look like this once in place.

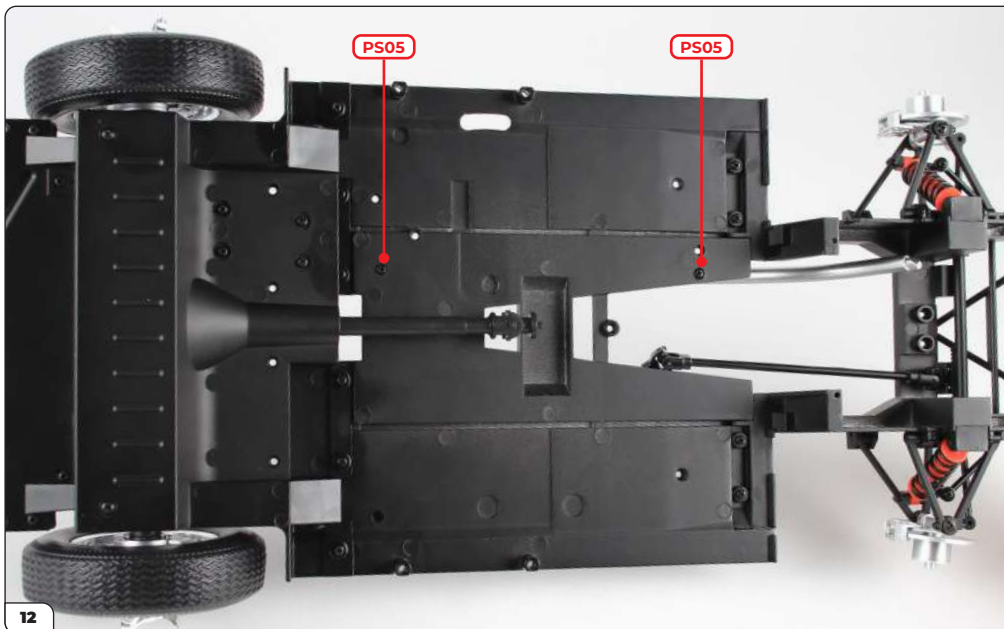

Secure from underneath with 2x PS05 screws.

Stage 042: Installing the Exhaust Pipes

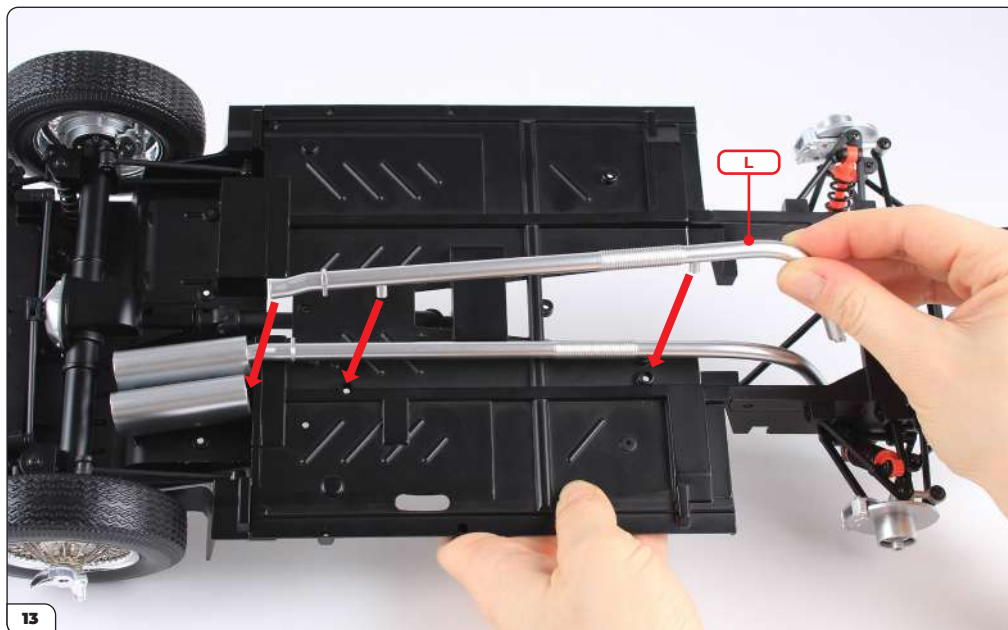

Fit the left exhaust pipe ('L') in the same way.

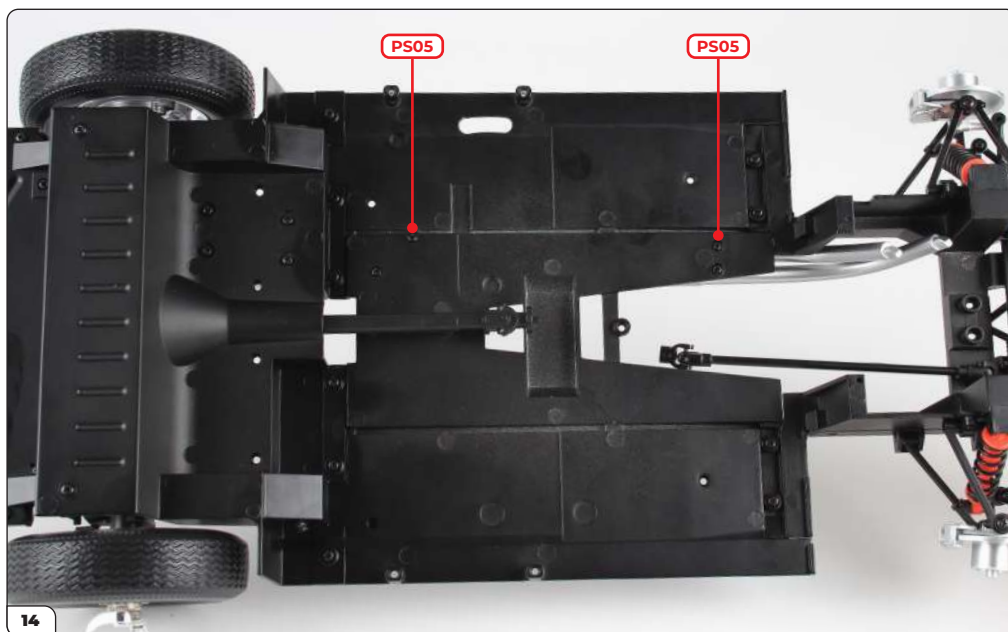

Secure with 2x PS05 screws.

Stage 042: Installing the Exhaust Pipes

STAGE COMPLETE



Stage 043: Detailing the Cockpit Floor

Next you'll start to prepare the cockpit floor by fitting details including the carpeting, gearstick and handbrake. You'll also install the power switch.



STAGE 043 PARTS LIST

Name	Name
43-A Cockpit floor	43-H Power switch
43-B Switch bracket	PS05 screw x3
43-C Wire bracket x2	Carpet sticker 1
43-D Handbrake	Carpet sticker 2
43-E Gearstick cover	Carpet sticker 3
43-F Gearstick	Carpet sticker 4
43-G Gearstick knob	



Stage 043: Detailing the Cockpit Floor

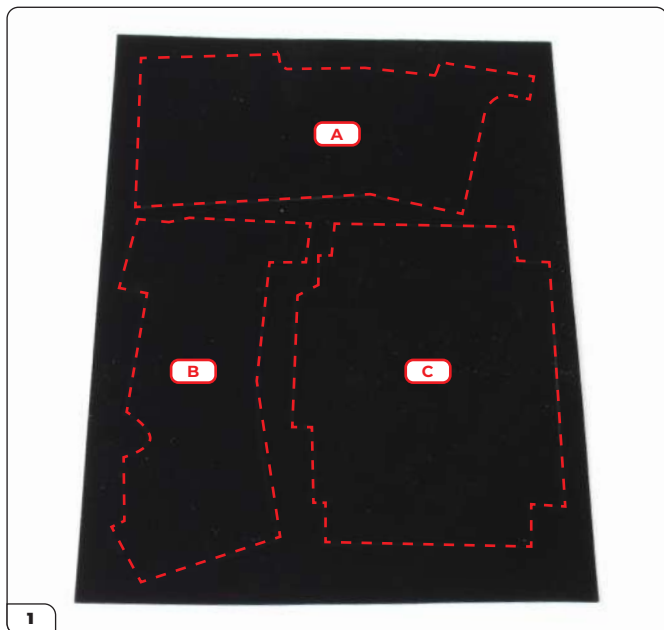

FITTING THE CARPETS

Take carpet sticker 2. Note there are three pieces on the sticker.



Carefully peel piece C from the backing. Cut around the edges with a crafting knife if any of them need separating (inset).

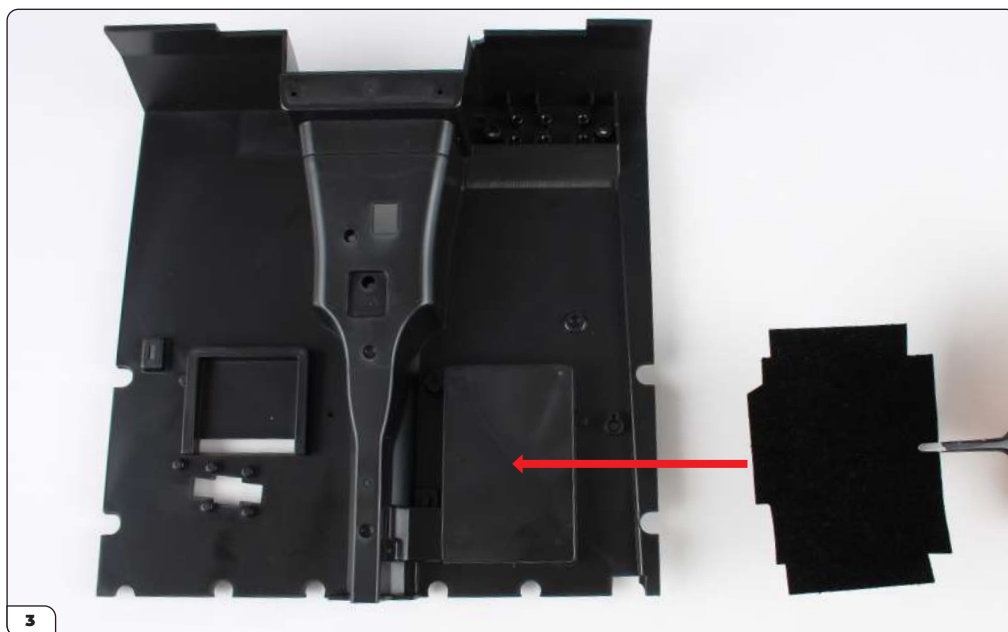

Align piece C with the raised rectangle on the cockpit floor (43-A) as shown.

Stage 043: Detailing the Cockpit Floor

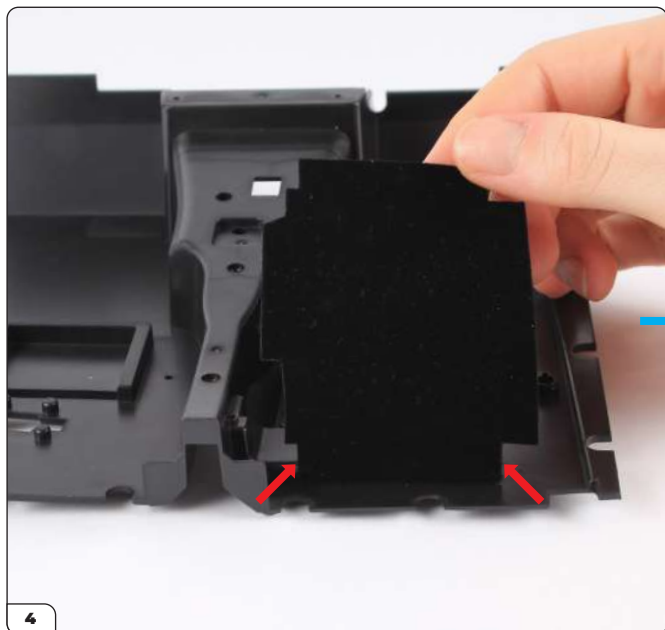

Start by sticking the piece to the front of the raised rectangle. Check the edges are aligned properly as shown by the arrows.

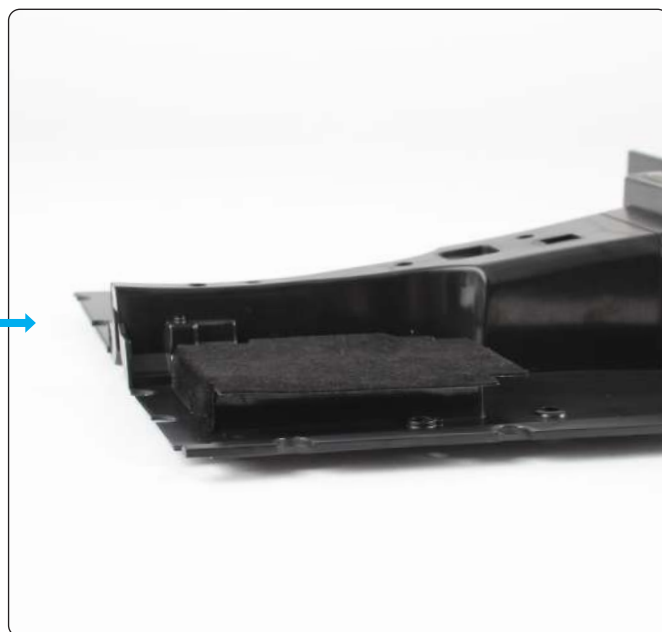

Pull the sticker tight and over the top of the rectangle.

Stage 043: Detailing the Cockpit Floor

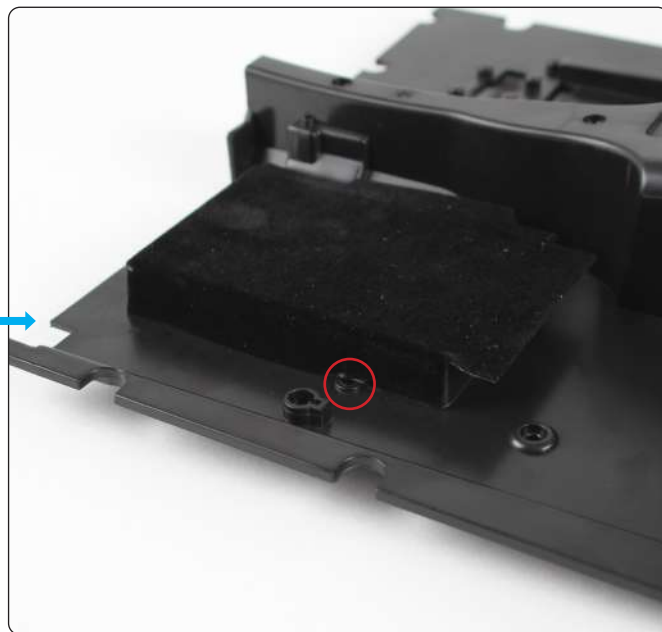

Press one of the edges down flat against the vertical side of the rectangle. You can use a flat tool, such as tweezers, to smooth it while pressing. Make sure the hole is left uncovered (circled).

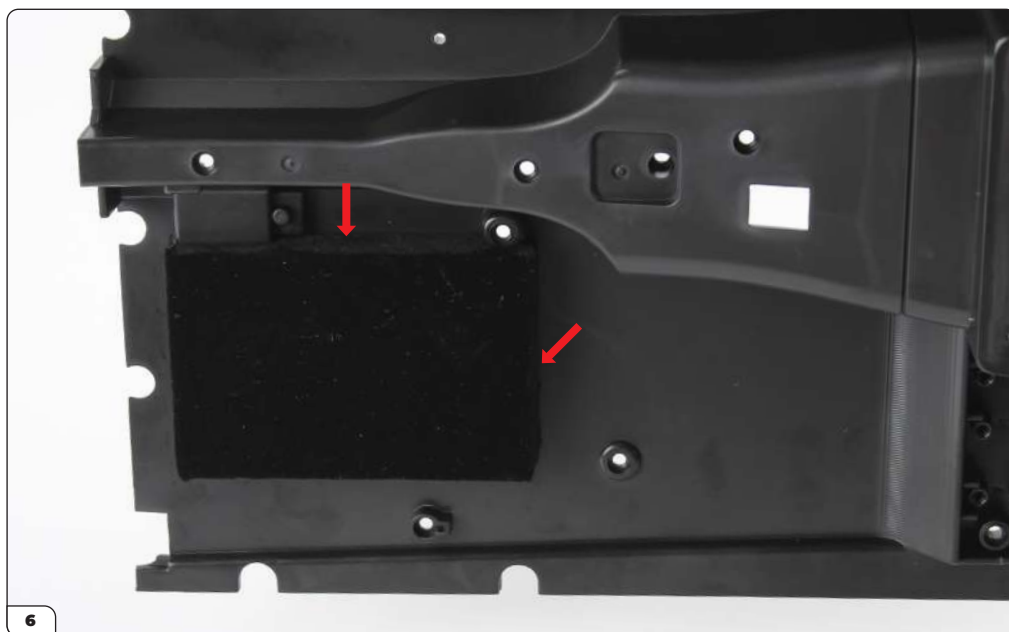

Repeat for the other sides.

Stage 043: Detailing the Cockpit Floor

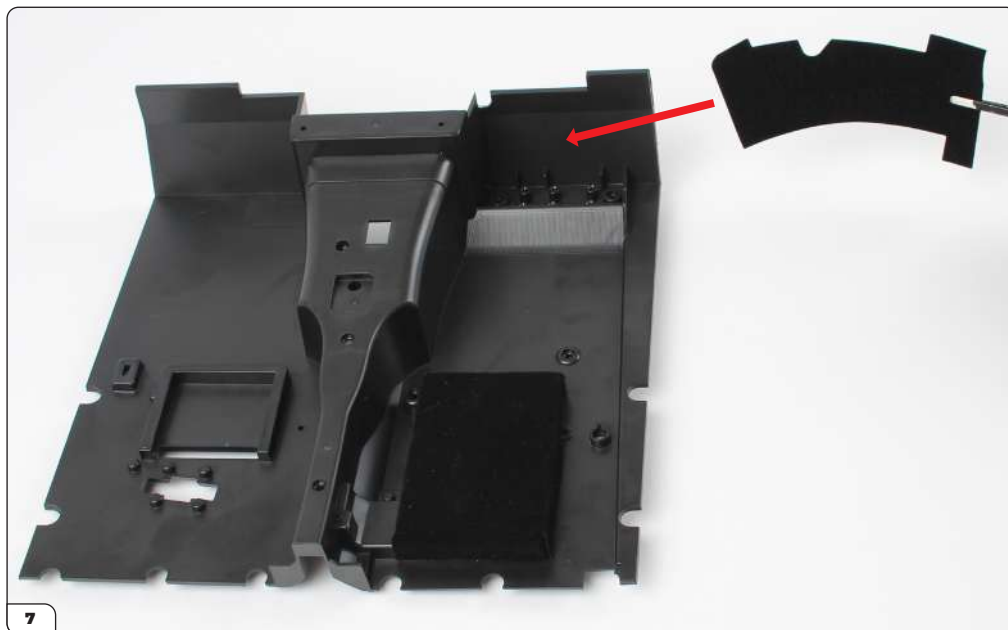

Peel piece B from the sticker sheet and align it with the back of the cockpit floor as shown.

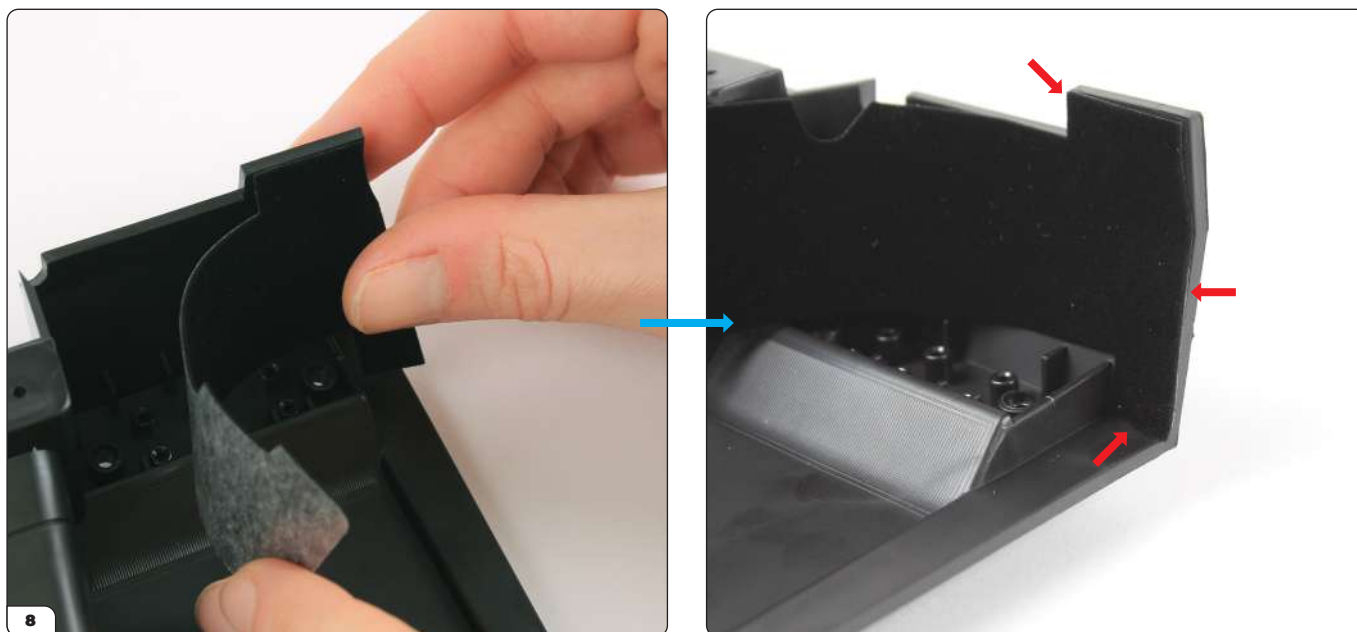

Start sticking on the outside edge of the cockpit and align the edges carefully.

Stage 043: Detailing the Cockpit Floor

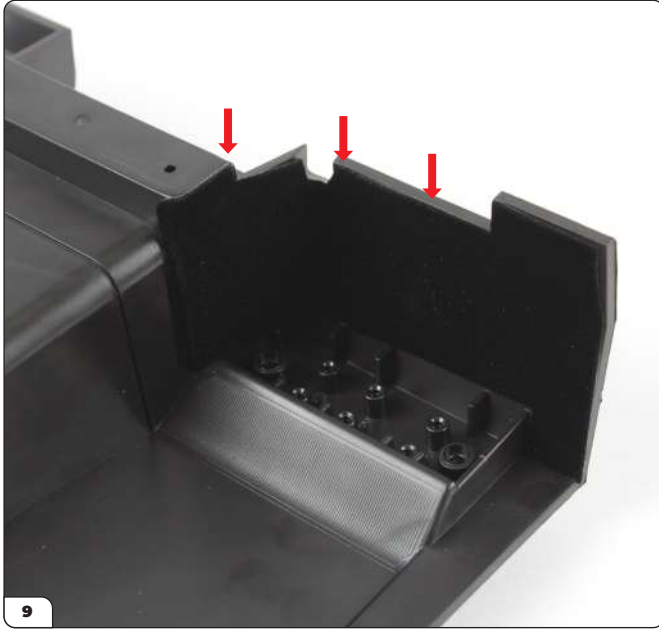

Continue sticking, pressing the carpet flat and aligning the edges.

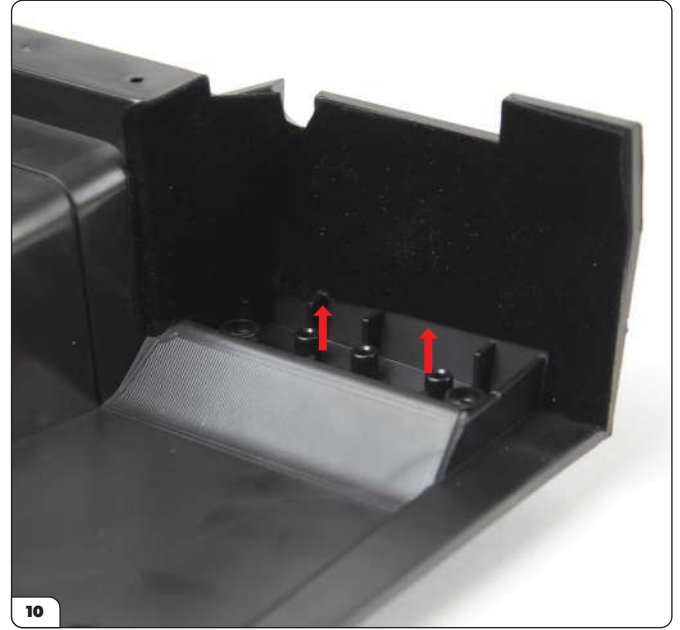

The sticker should look like this. Don't worry about overlapping on the bottom edge, this area will be covered in a later stage.

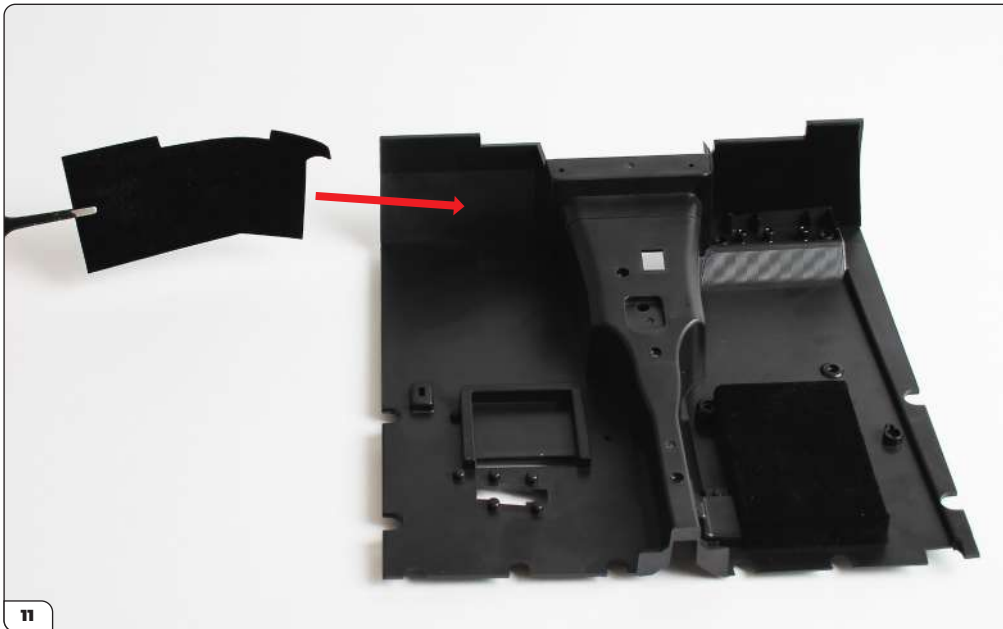

Take piece A and align it with the opposite side as shown.

Stage 043: Detailing the Cockpit Floor



Start by aligning the top and outside edges of the sticker.



Flatten the sticker into the corner.

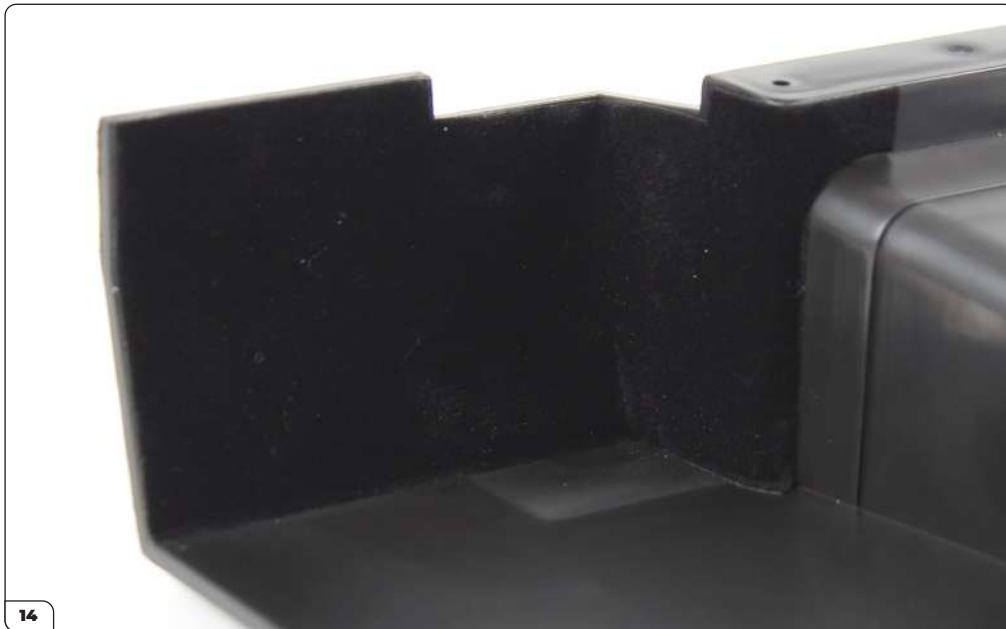

Wrap the sticker around the curve and press firmly in place

Stage 043: Detailing the Cockpit Floor

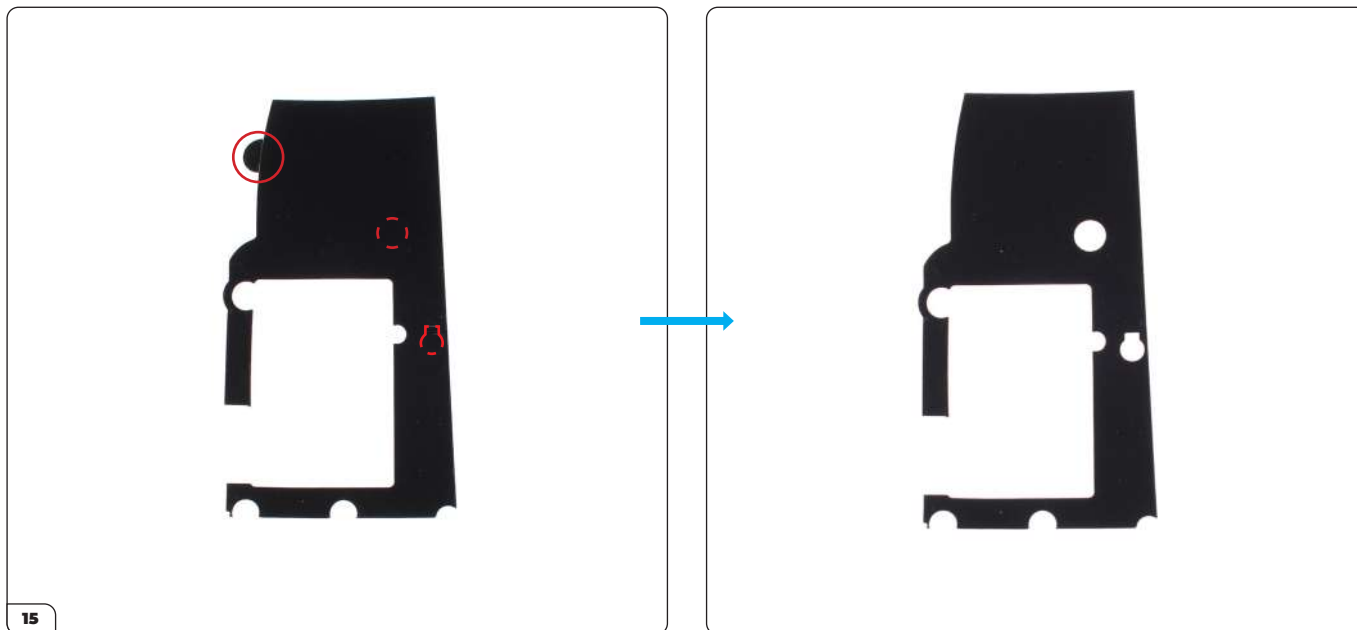

Now take carpet sticker 4 and remove the cut-out parts indicated. They will not be needed.

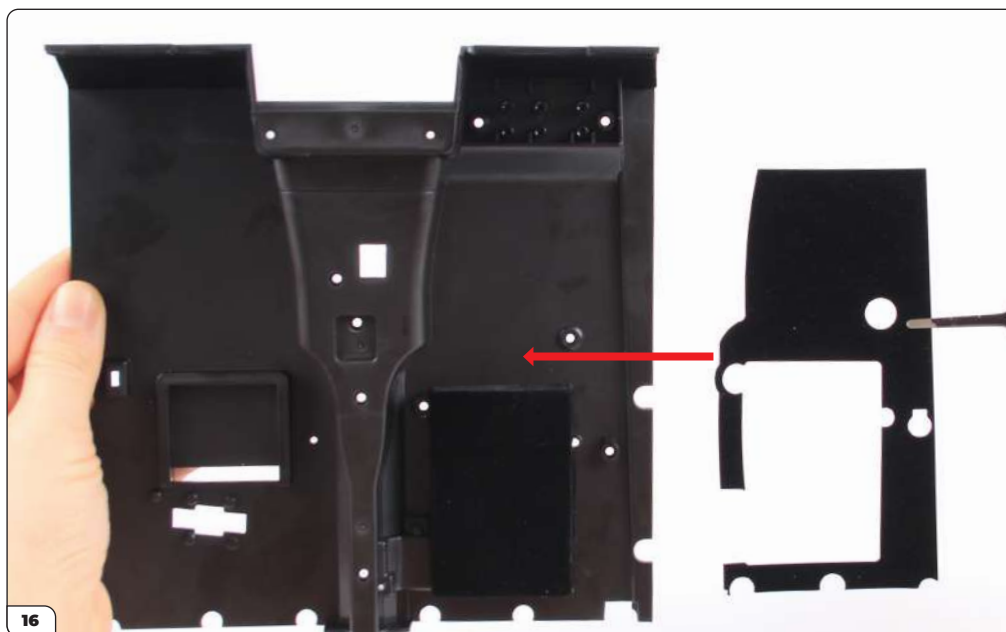

Align sticker 4 with the cockpit floor as shown.

Stage 043: Detailing the Cockpit Floor

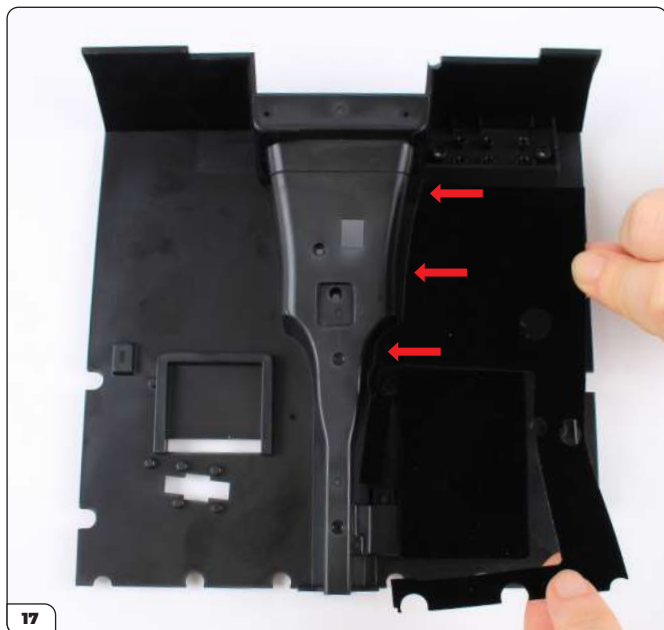

Start by sticking the larger area in place, fitting it into the inside edge.

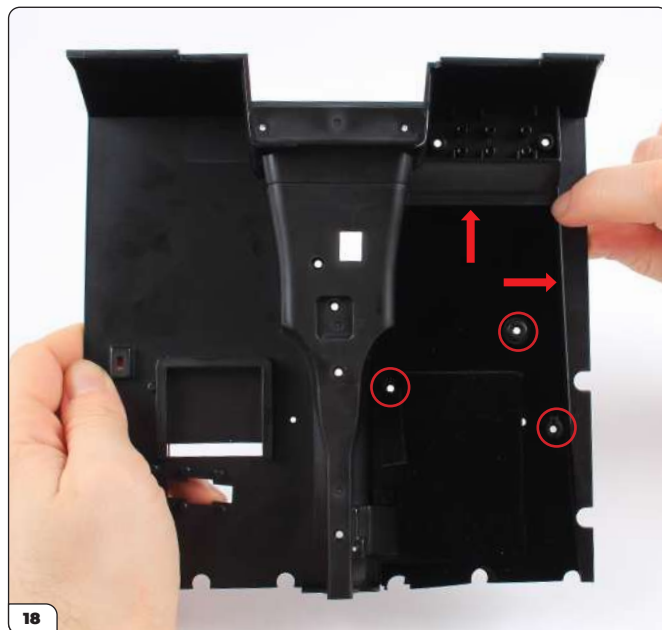

Align the outside edges and press the large area in place, making sure the openings are aligned over the raised holes.

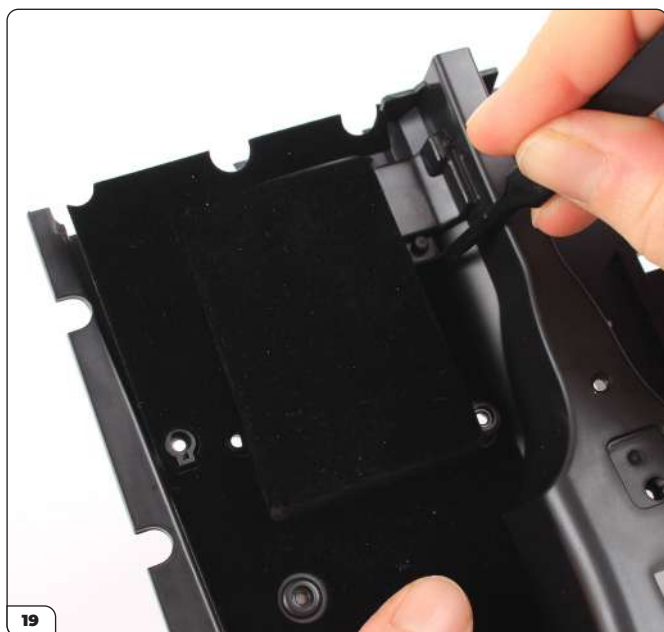

Press the remaining parts of the sticker firmly onto the floor.

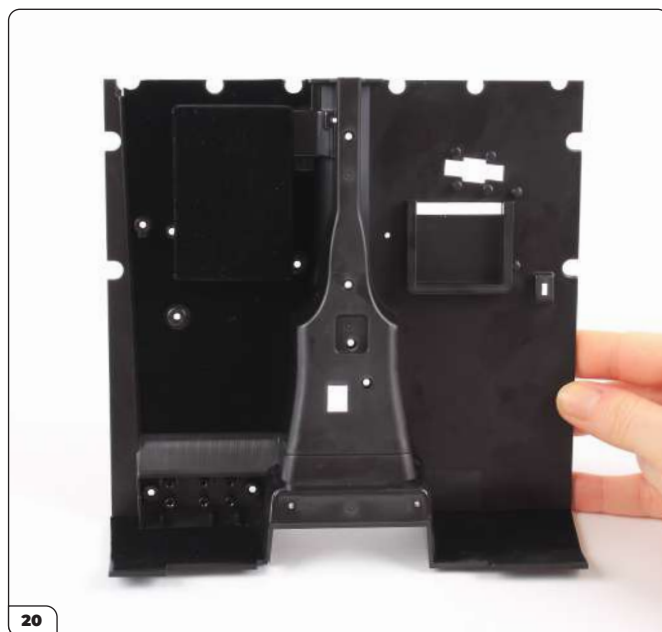

The sticker should look like this once in place.

Stage 043: Detailing the Cockpit Floor

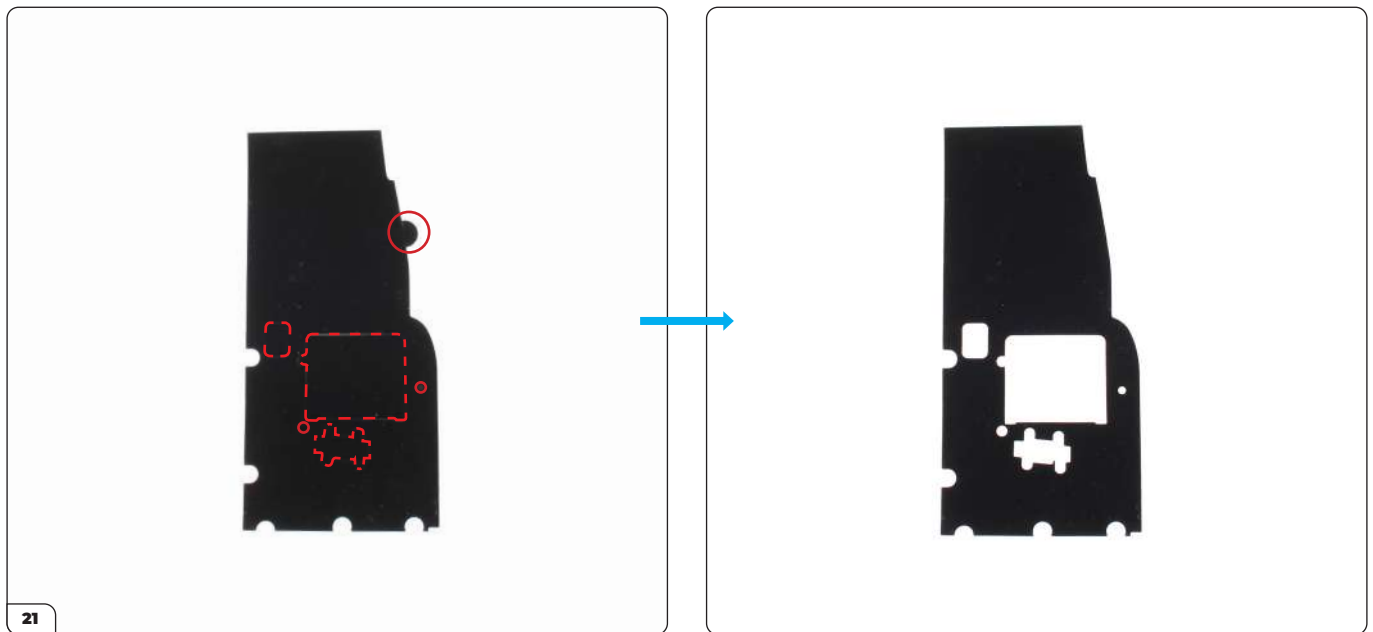

Now take carpet sticker 3 and remove the parts indicated. They will not be needed.

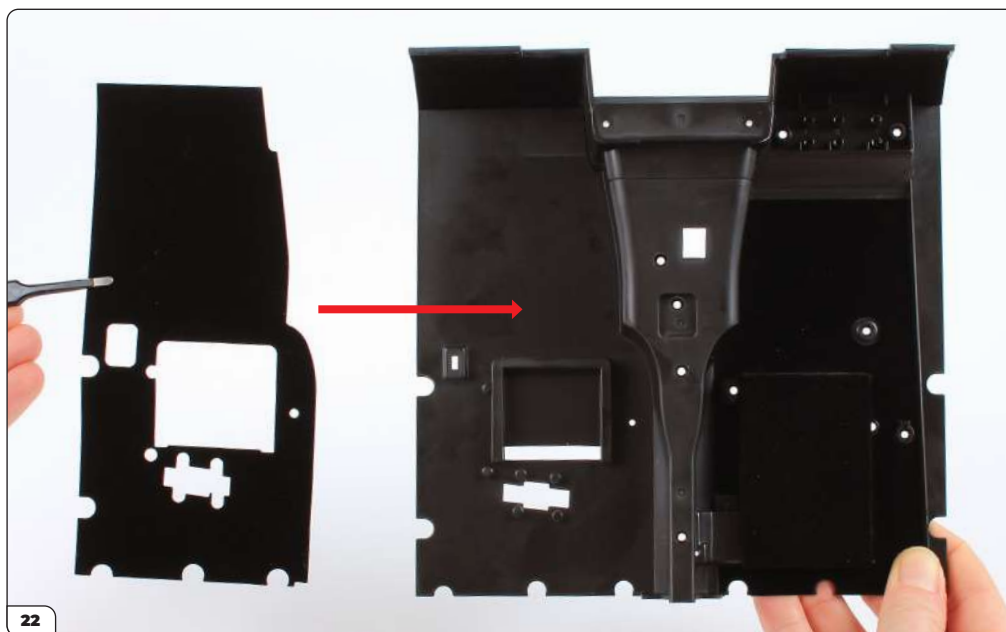

Align sticker 3 with the cockpit floor as shown.

Stage 043: Detailing the Cockpit Floor



Start by fitting the shaped openings over the corresponding parts on the cockpit floor.

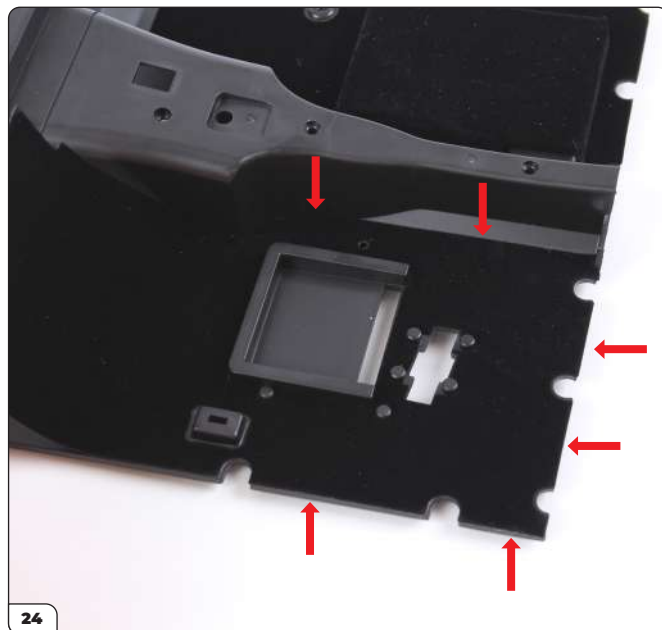

Once you are happy with the alignment, press the sticker down, checking the alignment of the edges.

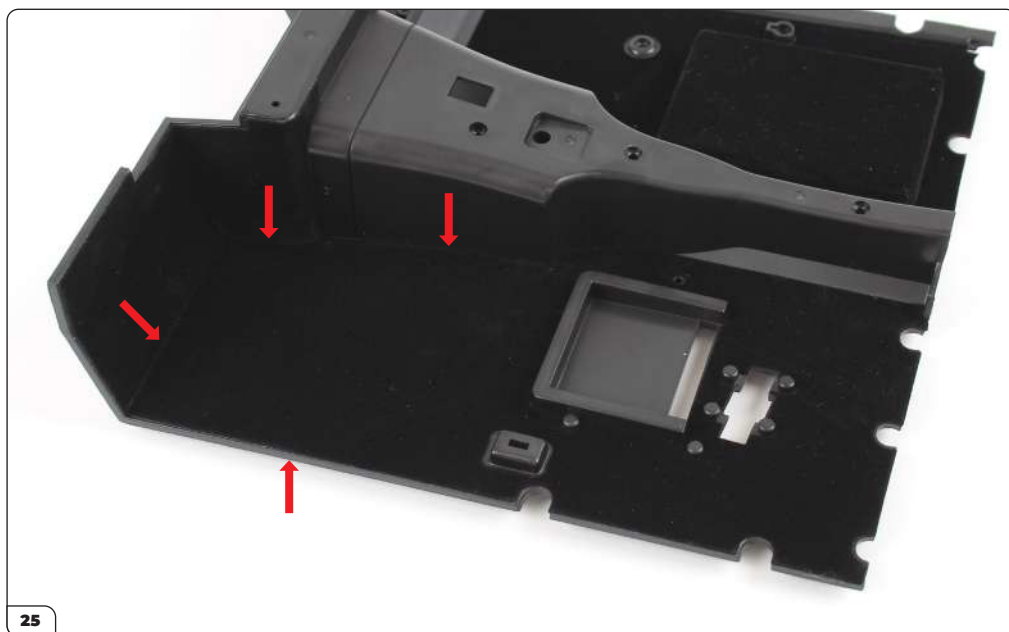

Press the large area of the sticker firmly in place in the same way as before.

Stage 043: Detailing the Cockpit Floor

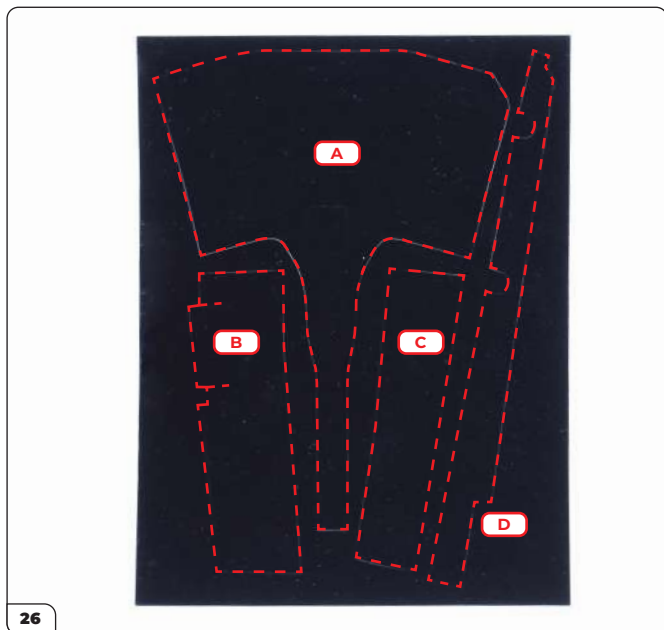

Take carpet sticker 1. Note there are four pieces on the sticker.

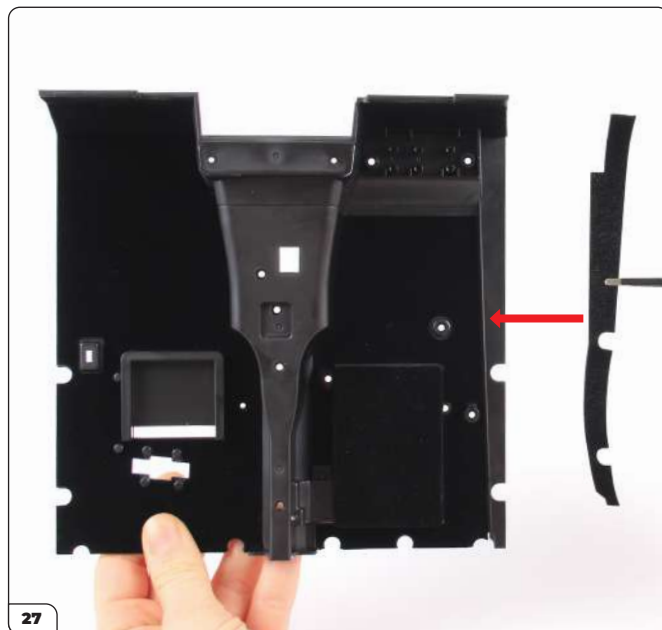

Align piece D with the left edge of the cockpit floor as shown.

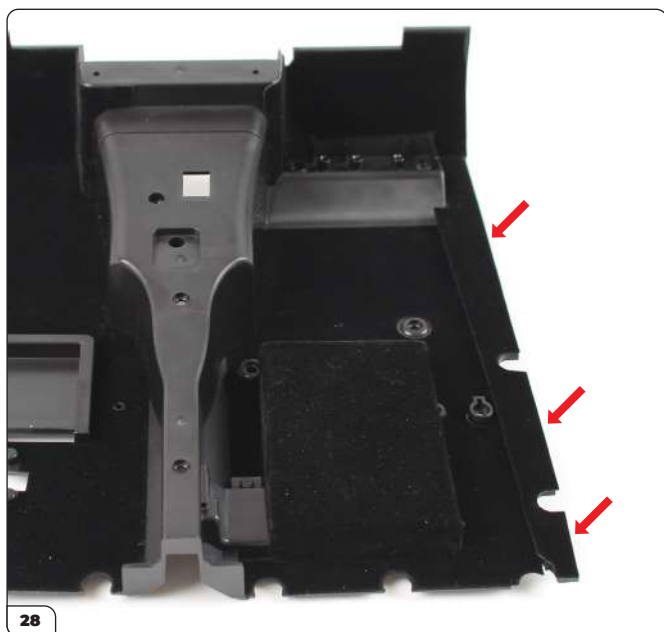

Press the sticker in place, aligning the outside edge.

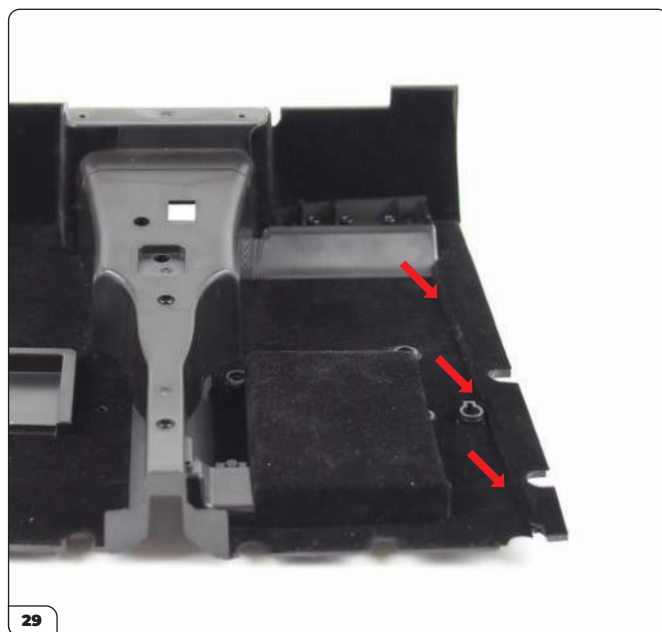

Press the overhanging section down as shown.

Stage 043: Detailing the Cockpit Floor



Align piece C with the right side of the transmission tunnel. One end is shorter than the other (circled) so check the orientation carefully.

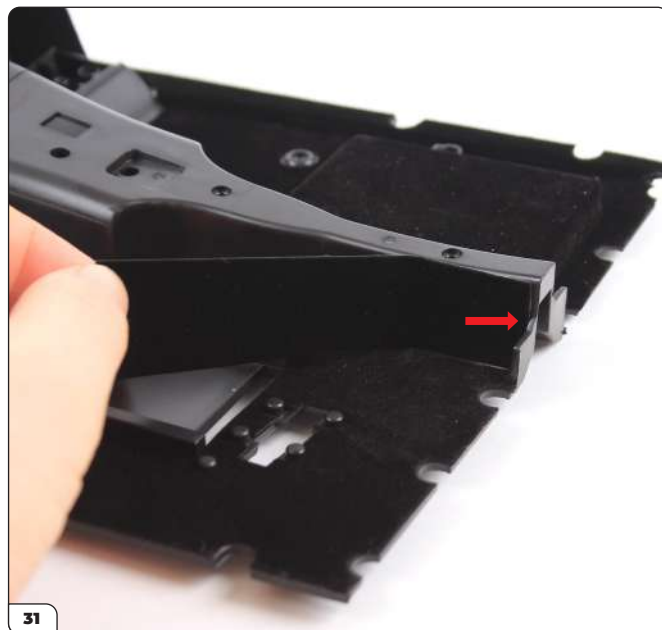

Press the shorter end in place.

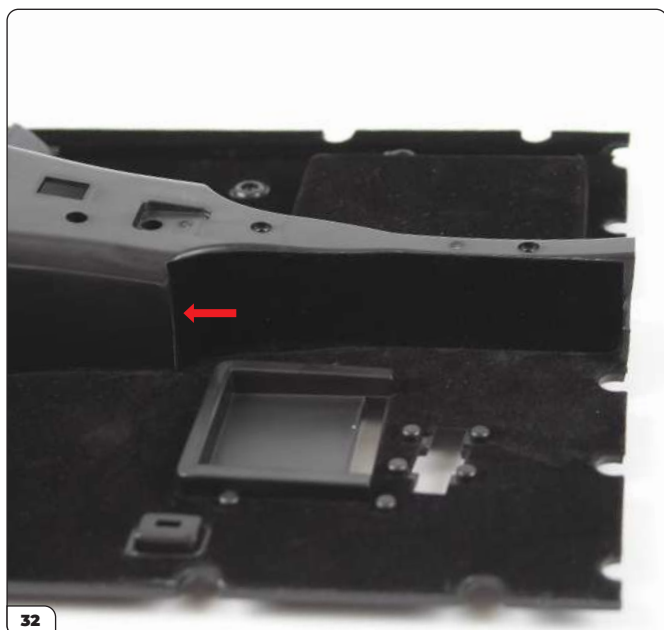

Press the rest of the sticker in place.

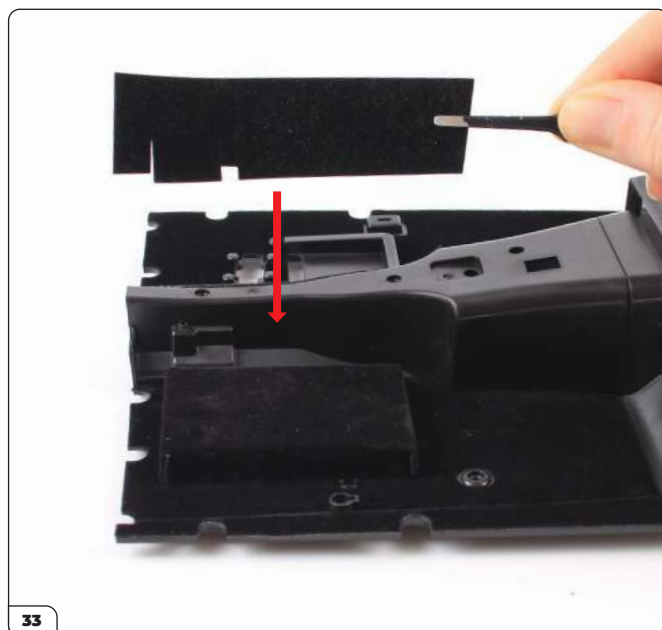

Align piece B with the opposite side of the transmission tunnel as shown.

Stage 043: Detailing the Cockpit Floor

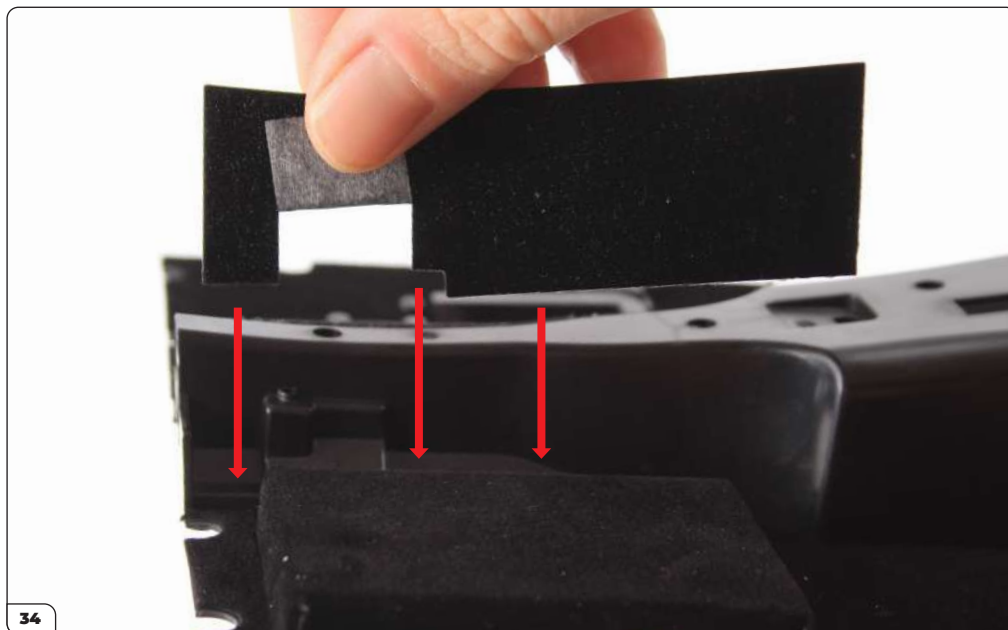

Start by lifting the sticker flap then pressing the bottom edges in place.



Press the flap down firmly.

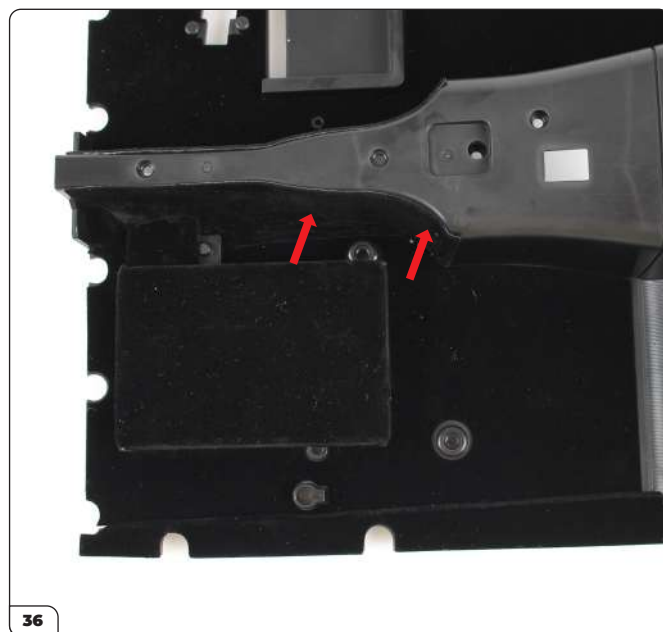

Press the remainder of the sticker against the transmission tunnel.

Stage 043: Detailing the Cockpit Floor

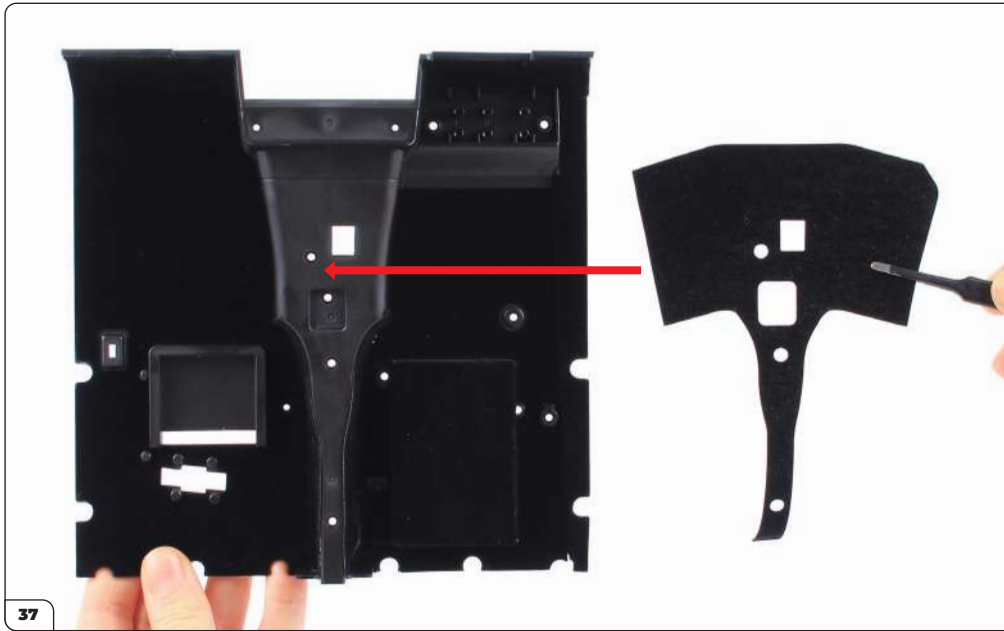

Take piece A and remove the cut-out parts. Align it with the top of the transmission tunnel.

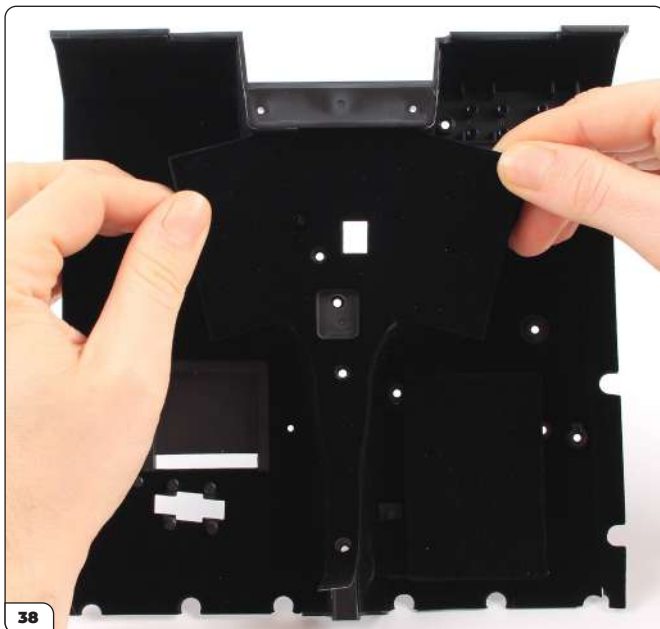

Start by positioning the sticker so that the shaped openings align with the corresponding parts on the transmission tunnel.



Press the edges down and stick in place, making sure to align any edges with the other carpet stickers. Once you're happy with the fit, brush over any edges with your fingers to blend the lines together.

Stage 043: Detailing the Cockpit Floor

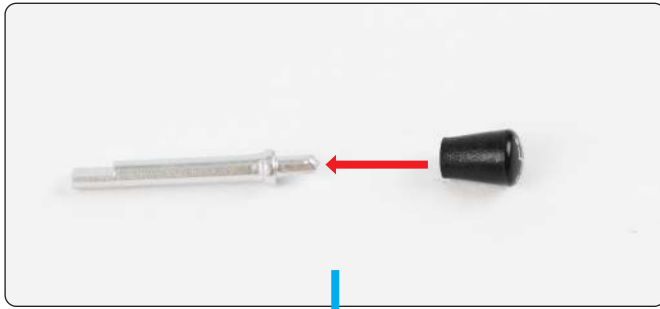

FITTING DETAILS TO THE COCKPIT FLOOR

Fit the gearstick knob (43-G) onto the end of the gearstick (43-F) as shown.

Important: the markings on the gearstick knob can rub off. Take care when fitting this part.

Fit the gearstick into the gearstick cover (43-E) using the shaped hole and pin.

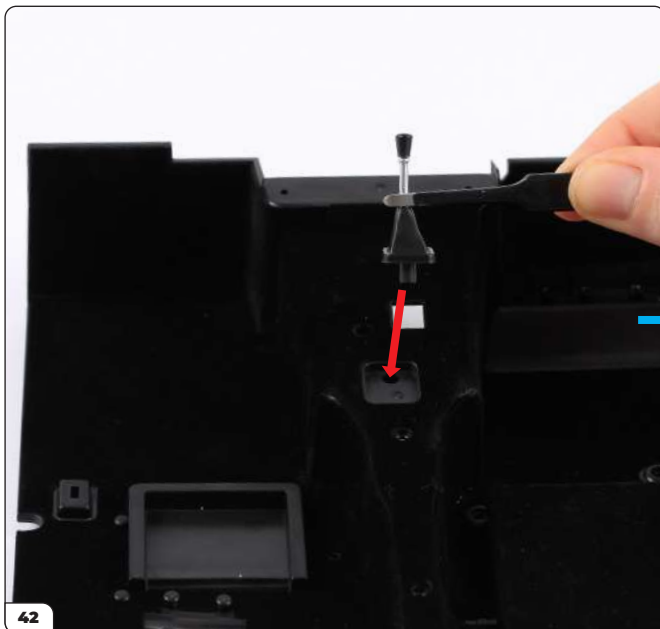

Fit the gearstick cover into the recess on top of the transmission tunnel.

Stage 043: Detailing the Cockpit Floor

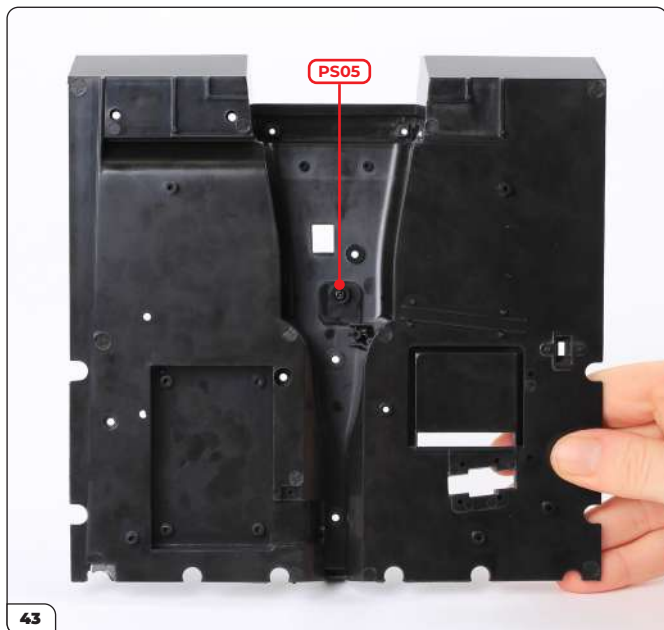

Secure from underneath using a PS05 screw.

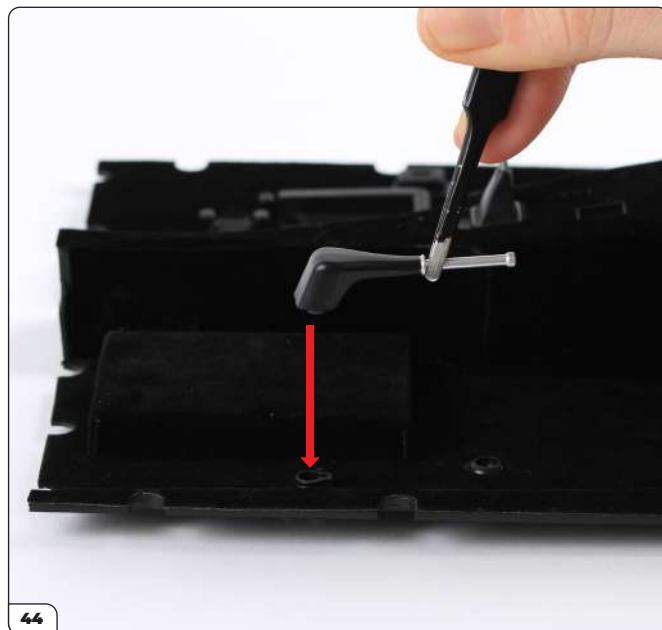

Fit the handbrake (43-D) into the shaped hole on the right-hand side of the cockpit floor.

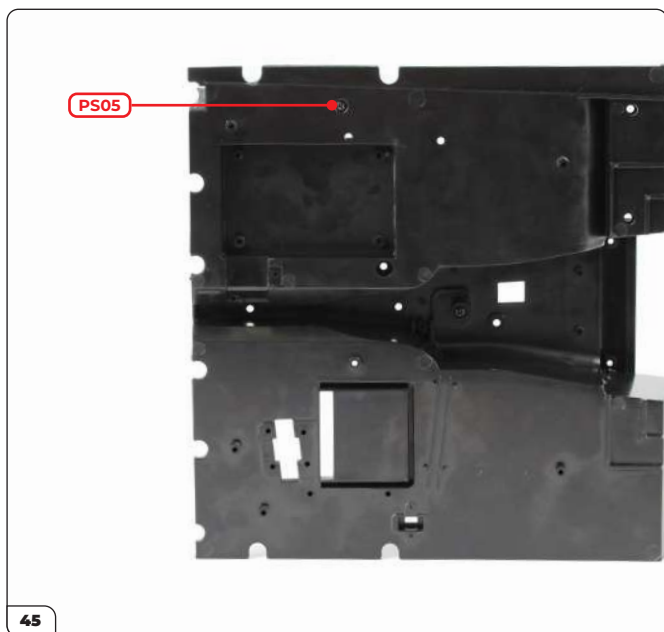

Secure from underneath using a PS05 screw.

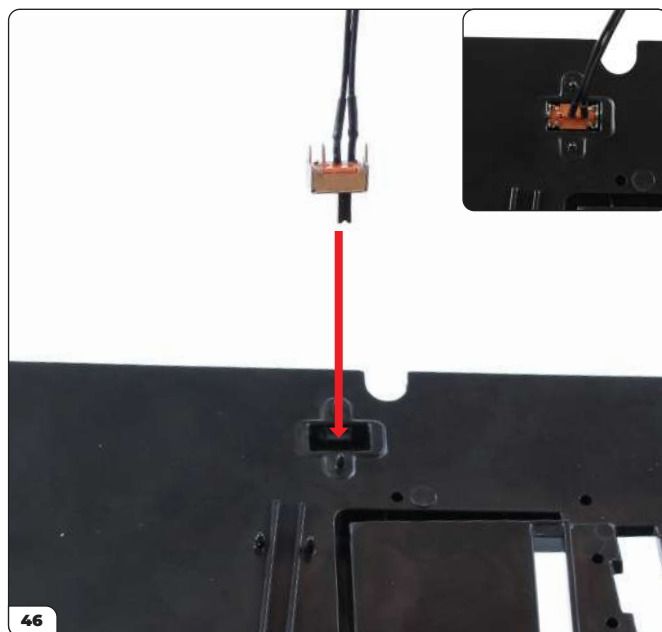

Push the power switch (43-H) firmly into the rectangular recess on the left-hand side.

Stage 043: Detailing the Cockpit Floor

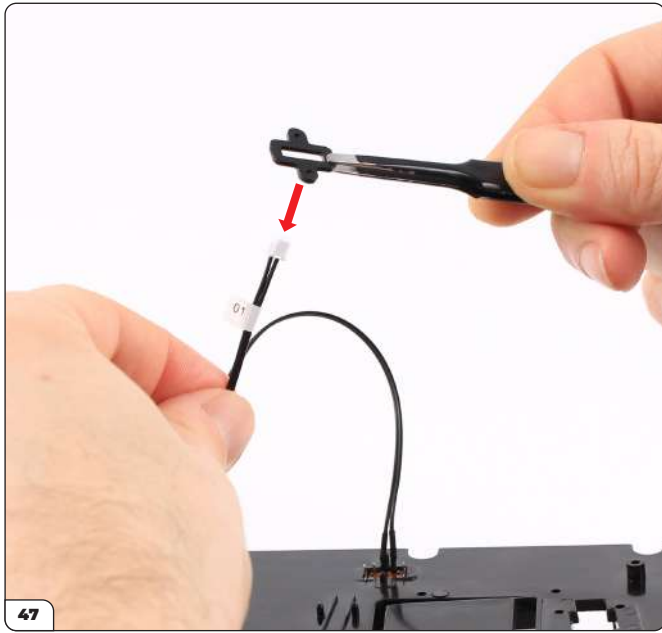

Thread the switch bracket (43-B) over the power switch wires.

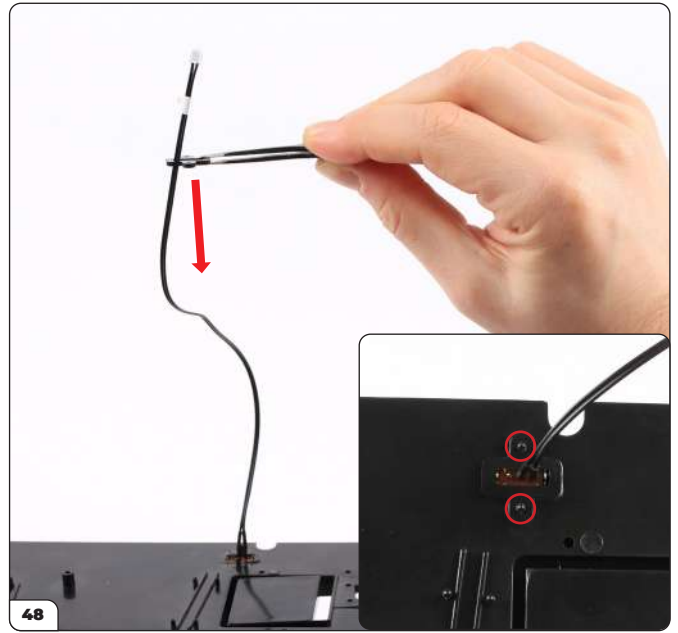

Run the bracket down the wires and press it firmly over the two pins next to the switch (inset).

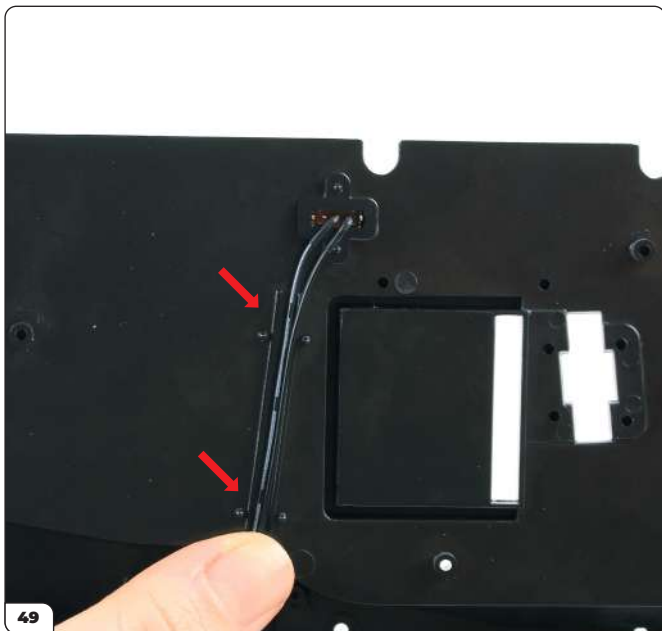

Carefully bend the wires and position them in the channel as shown.



Secure the wires by pressing the two wire brackets (43-C) over the pins.

Stage 043: Detailing the Cockpit Floor

STAGE COMPLETE



Stage 044: Assembling the Gadget Control Panel

In this stage you'll assemble the gadget control panel in the centre console and fit it to the cockpit floor, then install the pedals.



STAGE 044 PARTS LIST

Name	Name
44-A Centre console housing	44-G Brake pedal
44-B Centre console lid	44-H Accelerator pedal
44-C Gadget controls	44-I Hinge
44-D Gadget panel trim	44-J Button safety cover
44-E Pedal trim	PS05 screw x5
44-F Clutch pedal	PS26 screw x5



Stage 044: Assembling the Gadget Control Panel



1 Fit the gadget panel trim (44-D) over the gadget controls (44-C). Note the red button with two sockets next to it (circled).

2 Fit the button safety cover (44-J) into the two sockets next to the red button as shown.



3 Fit the gadget panel into the centre console housing (44-A).



4 Secure from underneath with a PS26 screw.

Stage 044: Assembling the Gadget Control Panel



Align the hinge (44-I) and the centre console lid (44-B). Make sure the barrel is oriented upwards as shown.

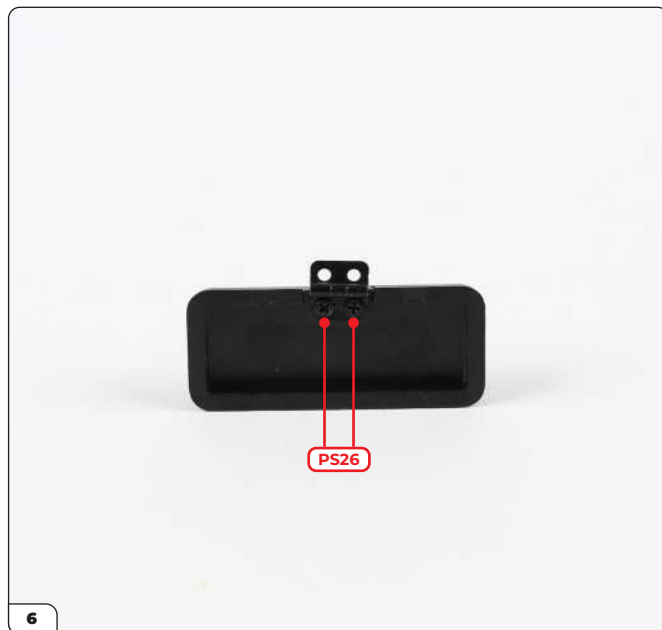

Fit the hinge and secure it with 2x PS26 screws.



Fit the lid hinge onto the two holes on the side of the housing.

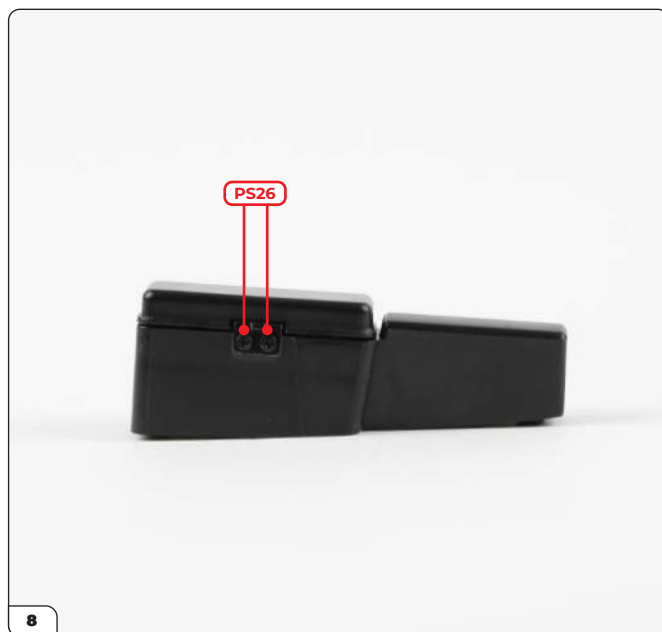

Secure with 2x PS26 screws.

Stage 044: Assembling the Gadget Control Panel

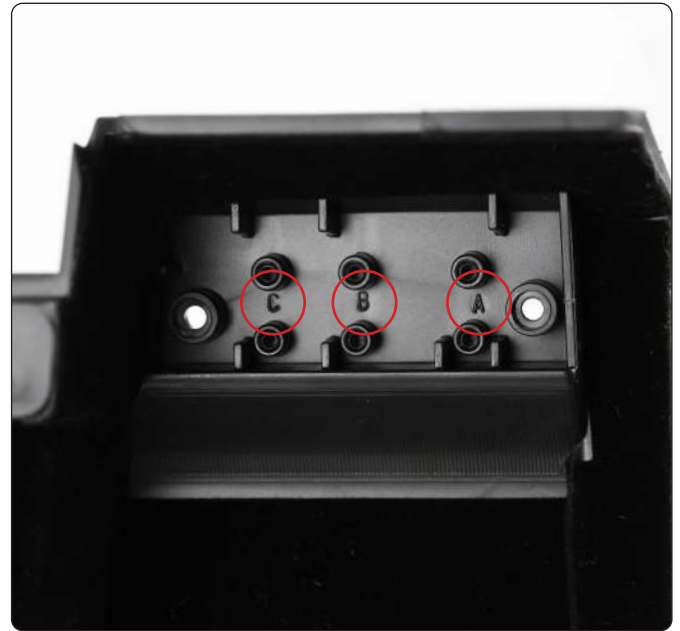

Take the three pedals. They have 'A', 'B' and 'C' printed on them to help fit them in the correct positions on the cockpit floor (right image).

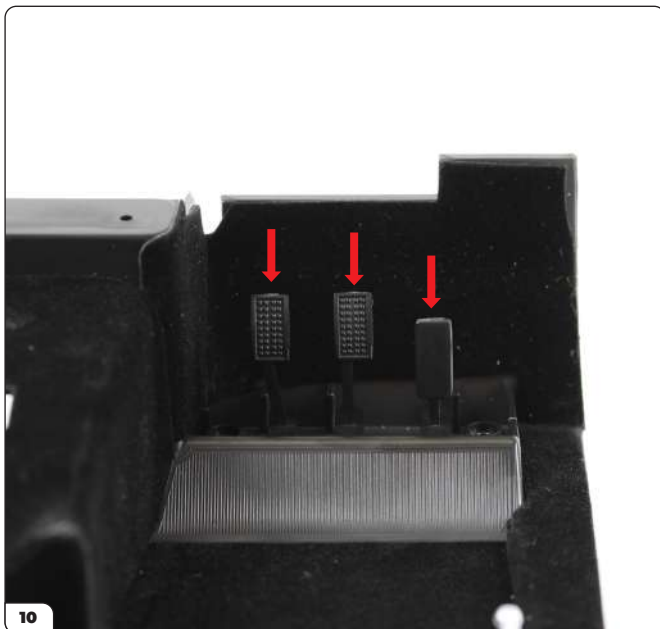

Fit the pedals in place matching the printed letters.

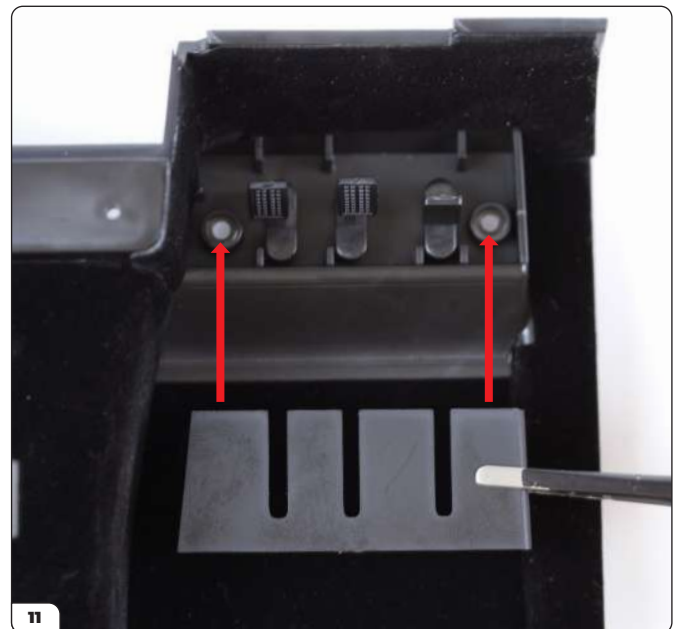

Align the pedal trim (44-E) as shown.

Stage 044: Assembling the Gadget Control Panel

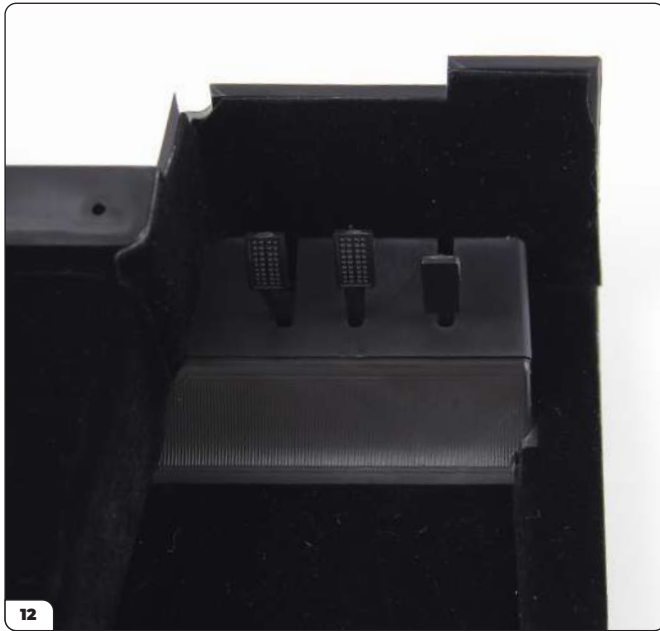

Fit the trim in place.

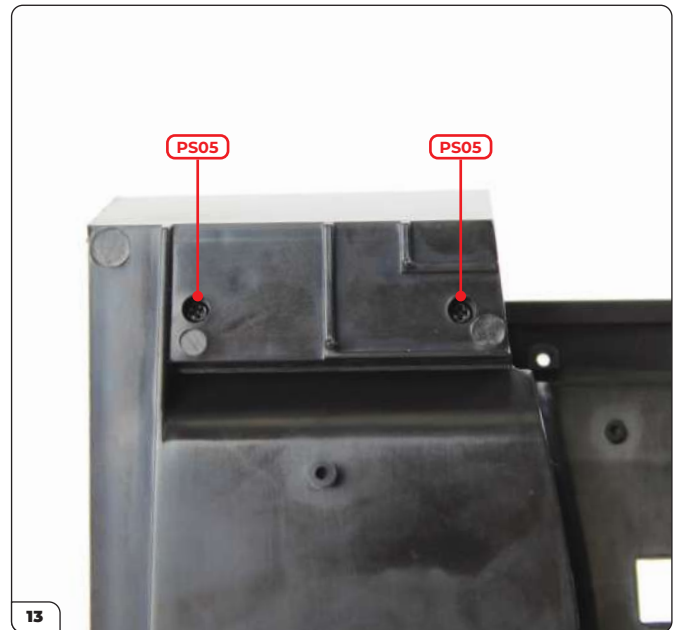

Secure from underneath with 2x PS05 screws.



Align the centre console with the transmission tunnel and fit into place as shown.
Note: you may wish to tape the lid closed so that it doesn't get damaged during assembly.

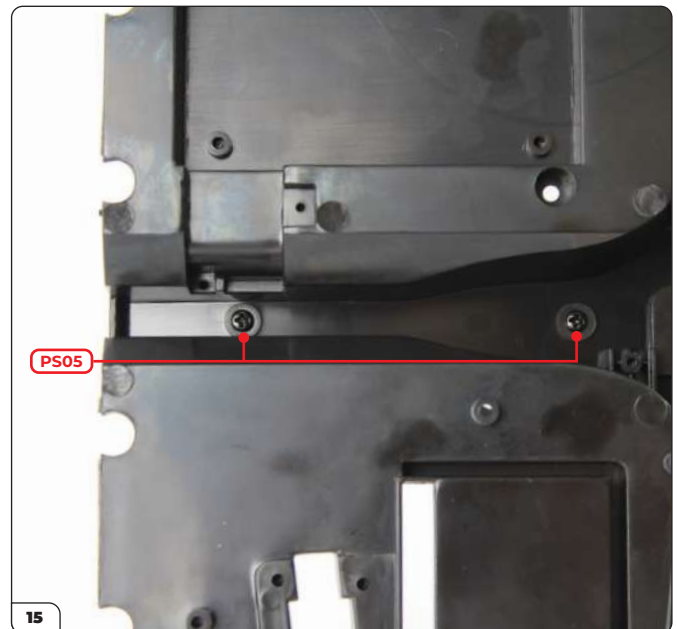

Secure from underneath with 2x PS05 screws.

Stage 044: Assembling the Gadget Control Panel

STAGE COMPLETE



Stage 045: Fitting the Circuit Board and Wires

The electronics of your model are controlled by the circuit board. After fitting, you'll connect the wiring and hide it in the transmission tunnel.



STAGE 045 PARTS LIST

Name	Name
45-A Main wire bracket	45-I Left machine gun motor LED '06'
45-B Tunnel wire bracket x2	45-J Right machine gun motor LED '07'
45-C Channel wire bracket x2	45-K Front number plate wire '08'
45-D Circuit board	45-L Rear number plate wire '09'
45-E Front left light wire '02'	45-M Speaker wire '10'
45-F Front right light wire '03'	45-N Instrument panel wire '11'
45-G Left machine gun motor wire '04'	PS05 screw x5
45-H Right machine gun motor wire '05'	PS14 screw x5

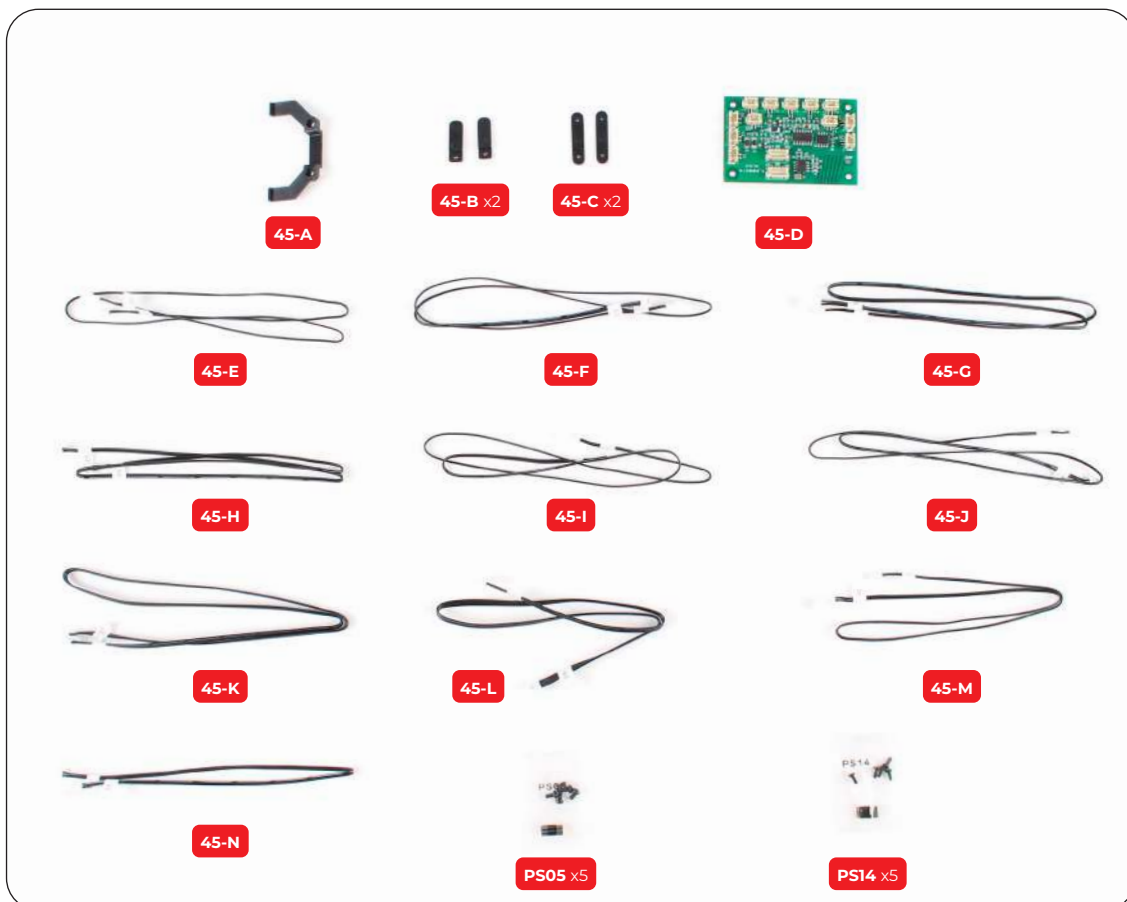

Stage 045: Fitting the Circuit Board and Wires

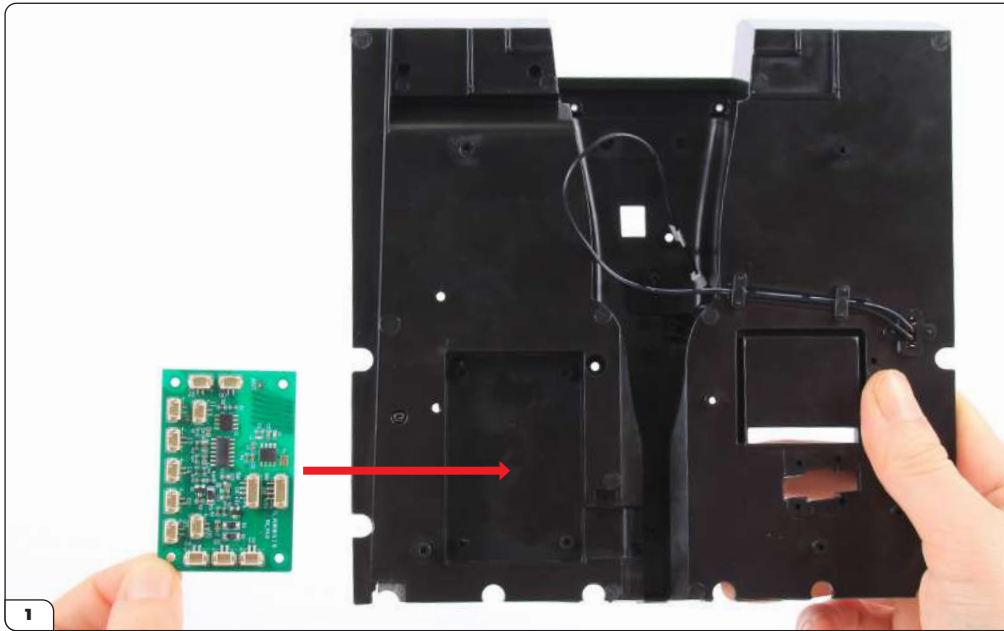

Start by aligning the circuit board (45-D) with the underside of the cockpit floor assembly (stage 044) as shown.

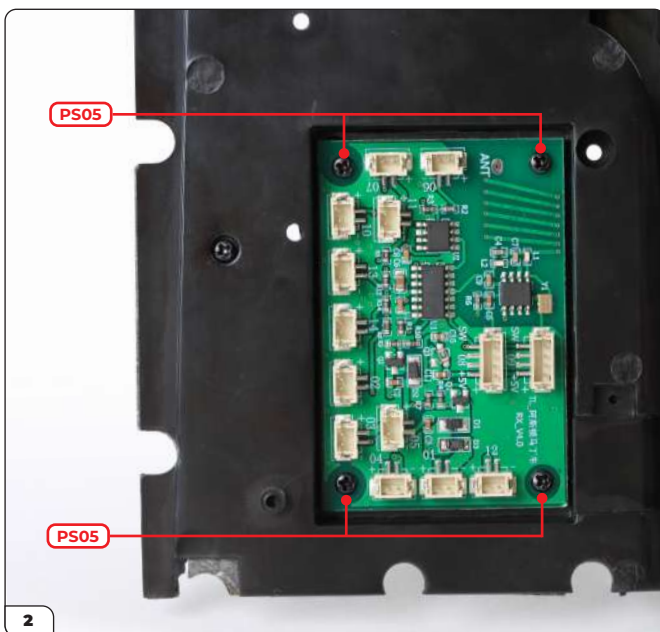

Fit the circuit board in place and secure with 4x PS05 screws.



Note that the circuit board sockets are marked with numbers which correspond to the numbered labels on the wires. Sockets 01 to 11 have been circled in the image.

Stage 045: Fitting the Circuit Board and Wires

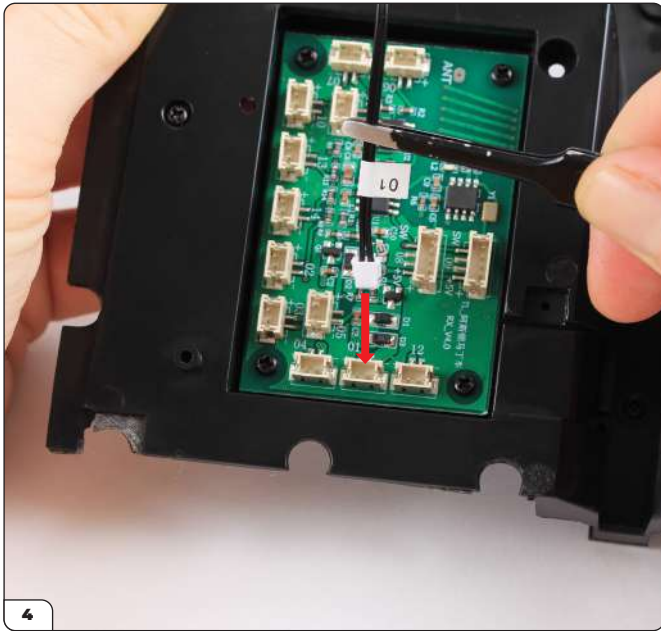

Take the power switch connector (labelled '01') and plug it into socket 01. Check the connector first to make sure it is oriented correctly.

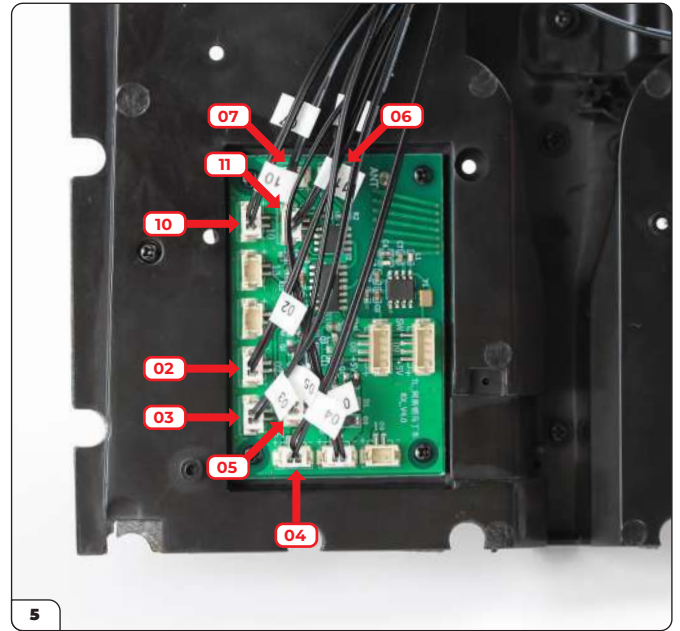

Plug all the wires with two-pin connectors (45-E to 45N) as indicated.

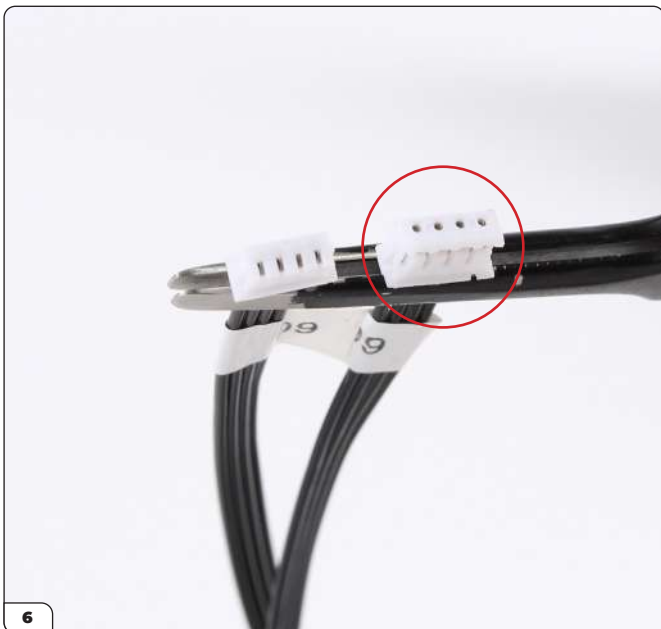

The four-pin connectors at each end of wires 45-K (08) and 45-L (09) are very similar. Use the connectors with the holes (circled) to plug into the circuit board.

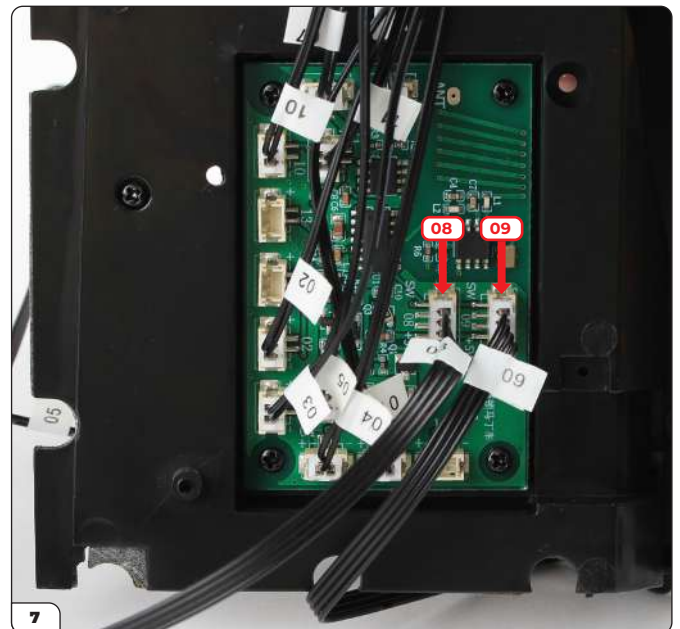

Plug the four-pin connectors in place.

Stage 045: Fitting the Circuit Board and Wires

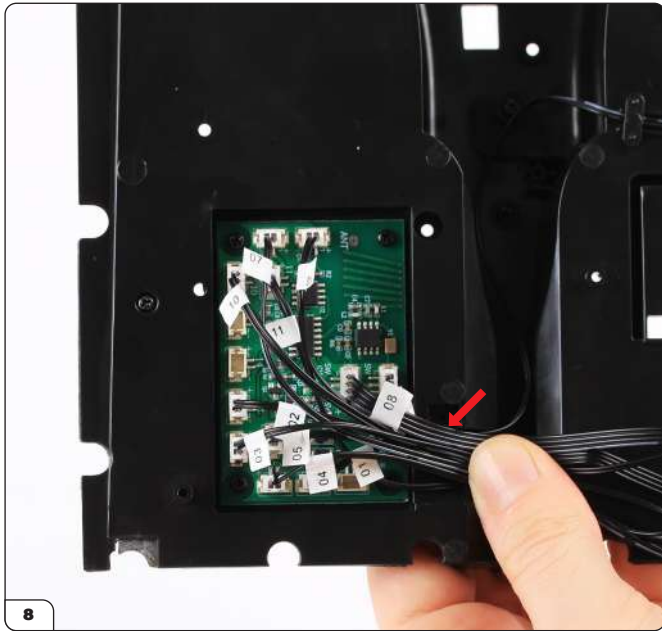

Gather the wires together and place them in the recess as shown.

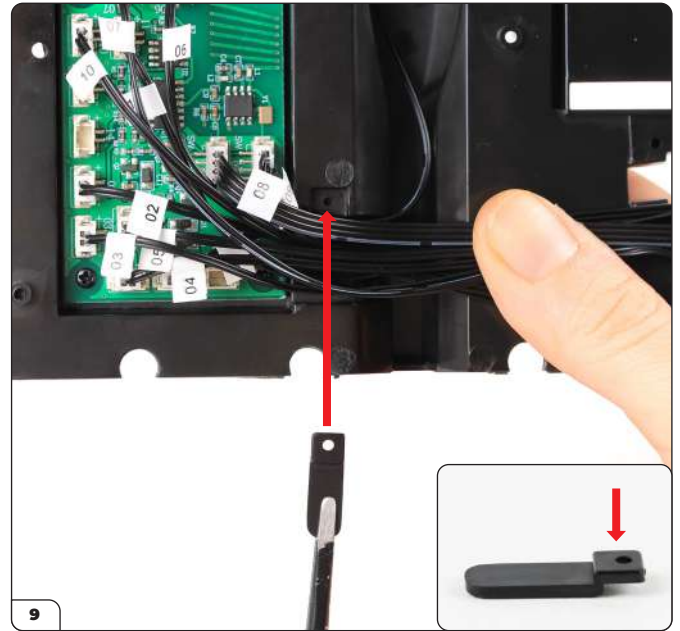

Take one of the tunnel wire brackets (45-B) and place it over the wires and onto the screw hole as shown. Orient the bracket with the tab on top (inset).

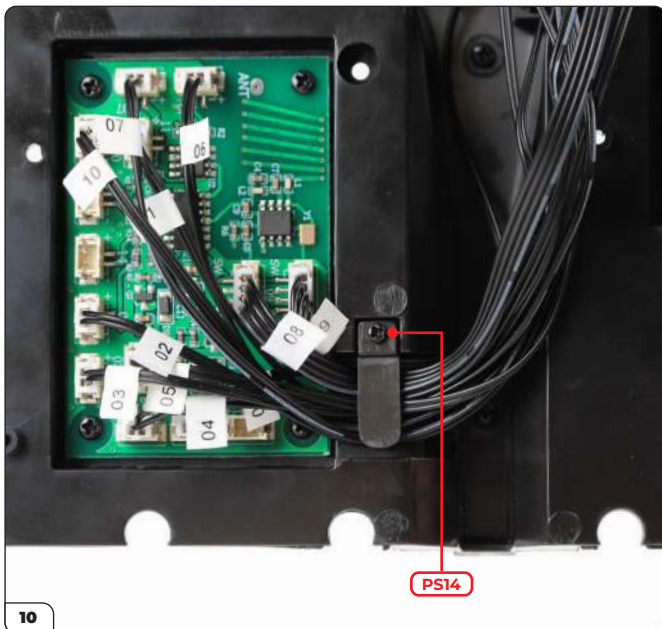

Fix in place with a PS14 screw.

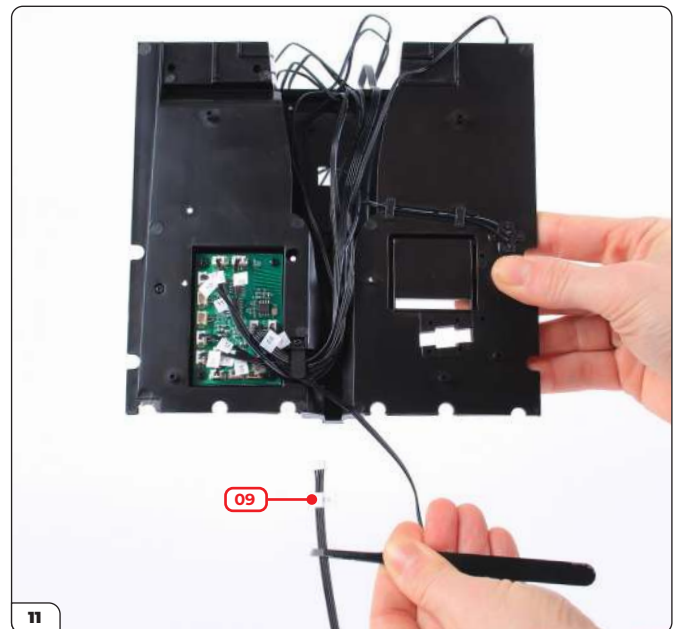

Locate wire 09 and guide it toward the rear of the transmission tunnel as shown.

Stage 045: Fitting the Circuit Board and Wires

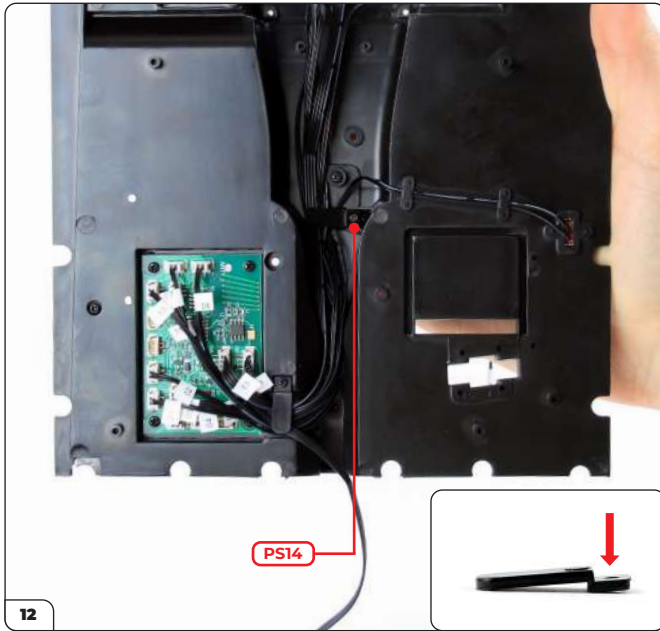

Take the other tunnel wire bracket (45-B) and use it to hold the wires in the middle of the tunnel, with the tab on the bottom (inset). Secure with a PS14 screw.

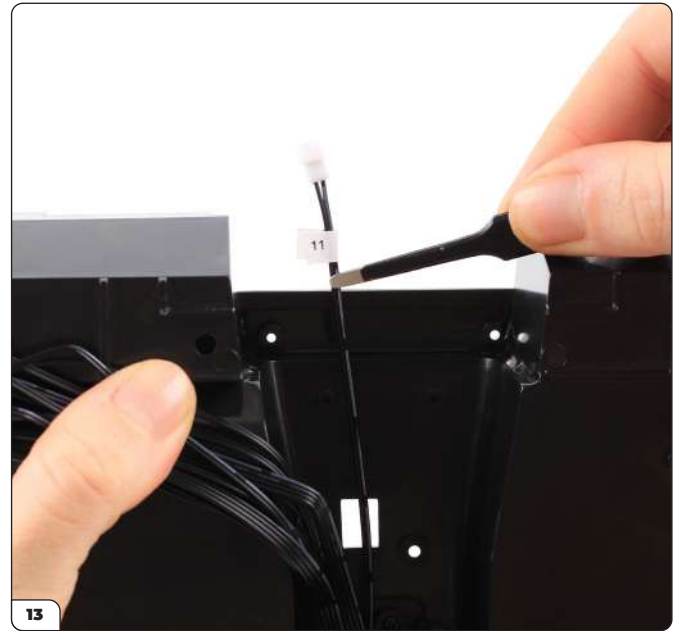

Locate wire 11.

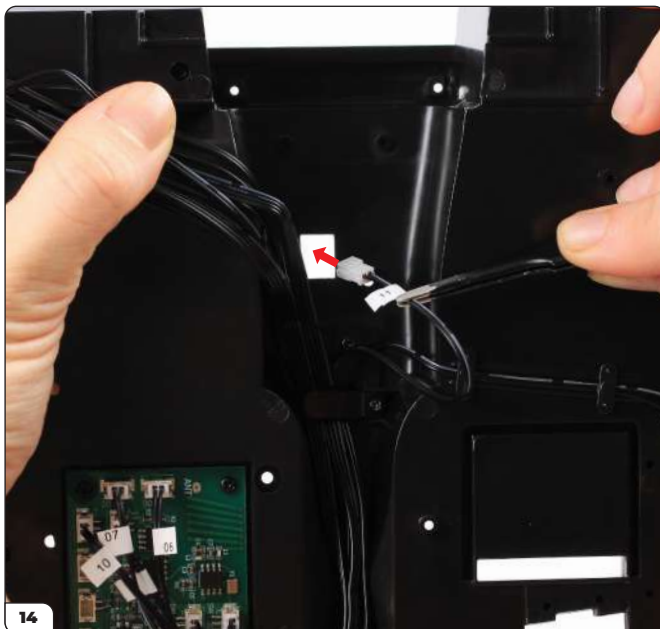

Feed the connector through the rectangular opening in the transmission tunnel.

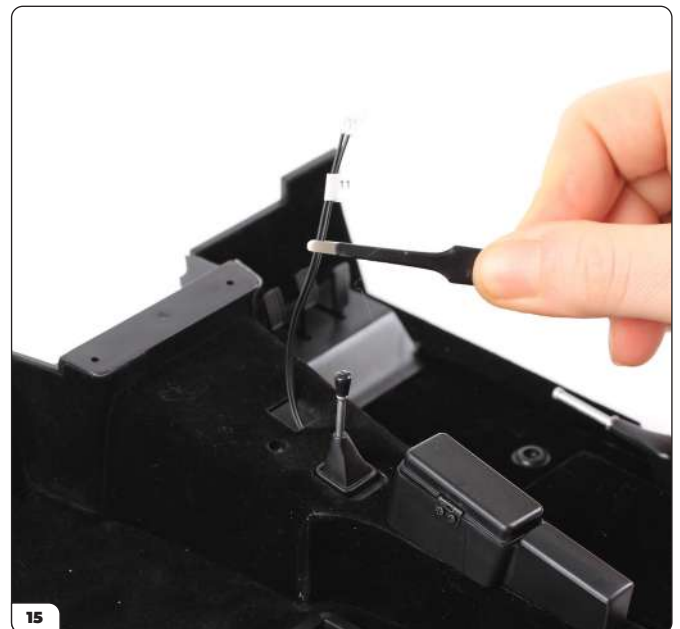

Pull the wire through from the other side.

Stage 045: Fitting the Circuit Board and Wires



Align the main wire bracket (45-A) with the screw holes. Gather the wires between the screw holes as shown.

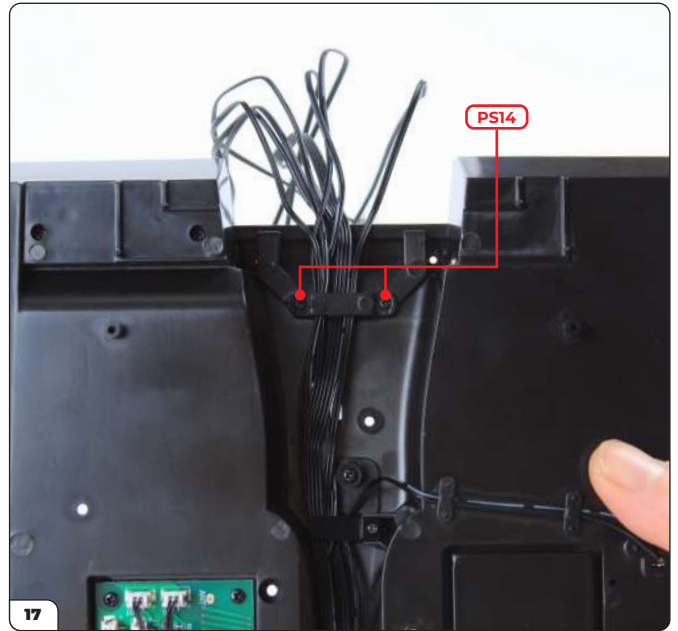

Fit the bracket over the wires and secure with 2x PS14 screws.

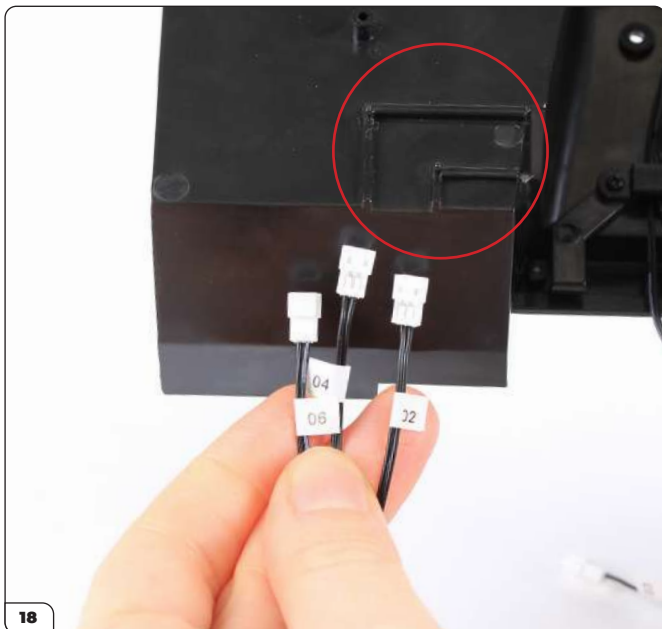

Face the assembly towards you and locate wires 02, 04 and 06. These will be fitted into the channel on the left-hand side (circled).

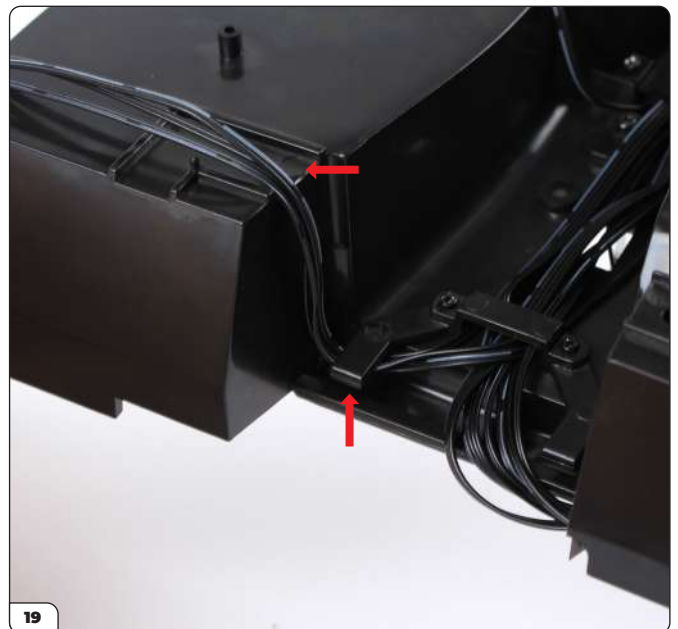

Hook the wires under the main wire bracket and guide them towards the left-hand channel as shown.

Stage 045: Fitting the Circuit Board and Wires



Use a channel wire bracket (45-C) to secure the wires, bending them to follow the channel.

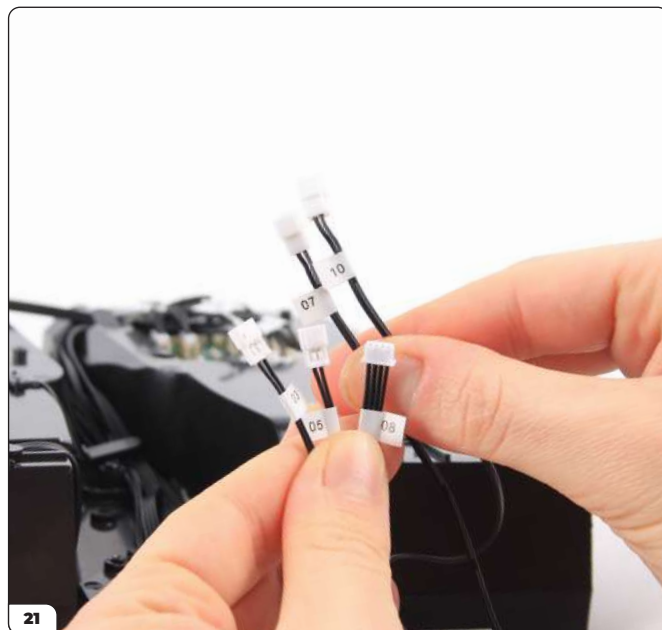

Take the remaining wires 03, 05, 07, 08 and 10.



Follow the same process to secure the wires in the right-hand channel with the other channel wire bracket (45-C).

Stage 045: Fitting the Circuit Board and Wires

STAGE COMPLETE

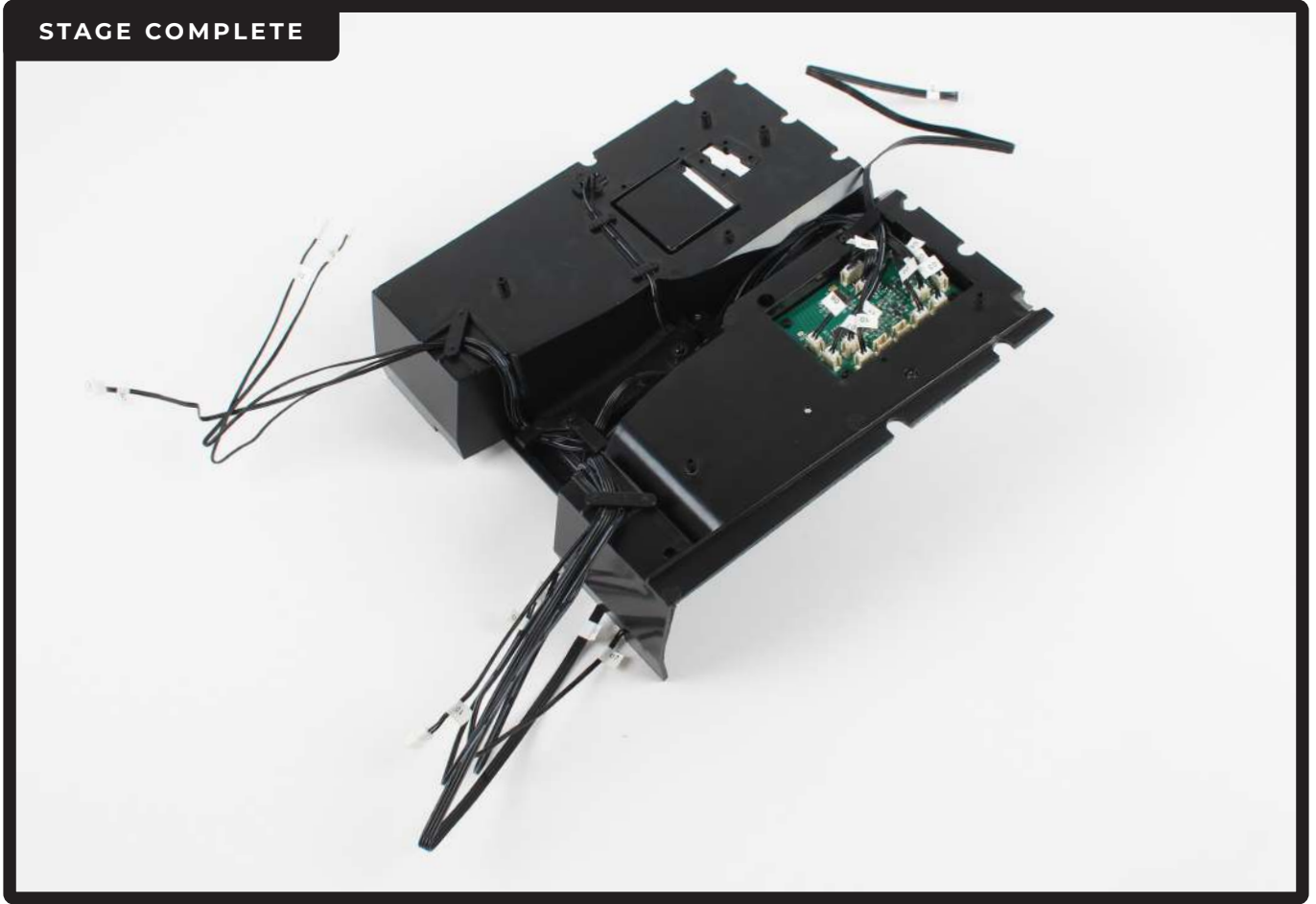

Stage 046: Preparing the Driver Seat Base

In this stage you'll prepare the driver's seat base ready to build and install it later.



STAGE 046 PARTS LIST

Name
46-A Driver seat base
46-B Driver seat cover
46-C Driver seat cushion
46-D Seat adjustment lever
46-E Seat adjustment handle
PS12 screw x2



Stage 046: Preparing the Driver Seat Base

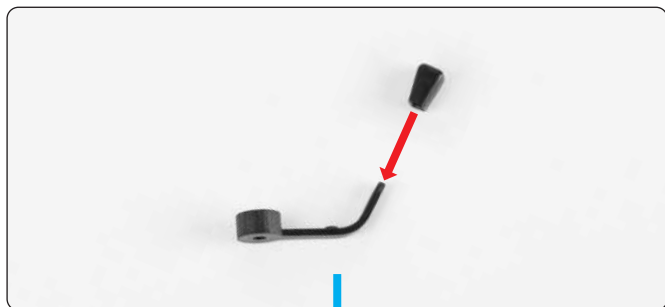

Fit the seat adjustment handle (46-E) onto the lever (46-D).



Align the adjustment lever with the shaped plug on the underside of the driver seat base (46-A).



Fit the lever and secure with a PS12 screw.



Turn the base over and fit the driver seat cushion (46-C) as shown.

Stage 046: Preparing the Driver Seat Base



Fit the driver seat cover (46-B) to the base.



Lift the shaped hole around the corresponding plug on both sides.



The assembly should now look like this.

Stage 046: Preparing the Driver Seat Base

STAGE COMPLETE



Stage 047: Assembling and Fitting the Driver Seat

Now you'll assemble the driver's seat then fit it into the cockpit. The backrest is fully adjustable and can be folded forward for passengers in the back seats.



STAGE 047 PARTS LIST

Name	Name
47-A Driver backrest	47-G Seat bracket (R1)
47-B Driver backrest cover	47-H Backrest adjuster
47-C Driver backrest cushion	PS01 screw x3
47-D Backrest bracket (R1)	PS05 screw x3
47-E Backrest bracket (R2)	PS21 screw x5
47-F Seat bracket (R2)	PS36 screw x3



Stage 047: Assembling and Fitting the Driver Seat



Align the driver backrest cushion (47-C) with the base (47-A) as shown.



Fit the cushion in place so that the top curve aligns with the base as shown by the dashed line.



Align the driver backrest cover (47-B) with the base.



Fit the cover onto the base, lifting the shaped holes to fit over the corresponding plugs.

Stage 047: Assembling and Fitting the Driver Seat



These images shown the shaped openings fitted over the plugs.



Take the seat and backrest brackets marked 'R2' (47-E and 47-F).

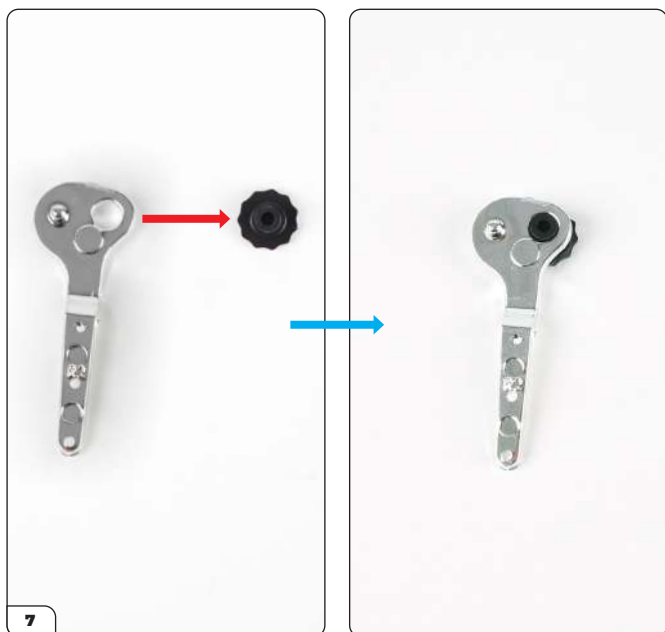

Align the seat bracket with the raised screw hole on the backrest adjuster (47-H) then fit in place.

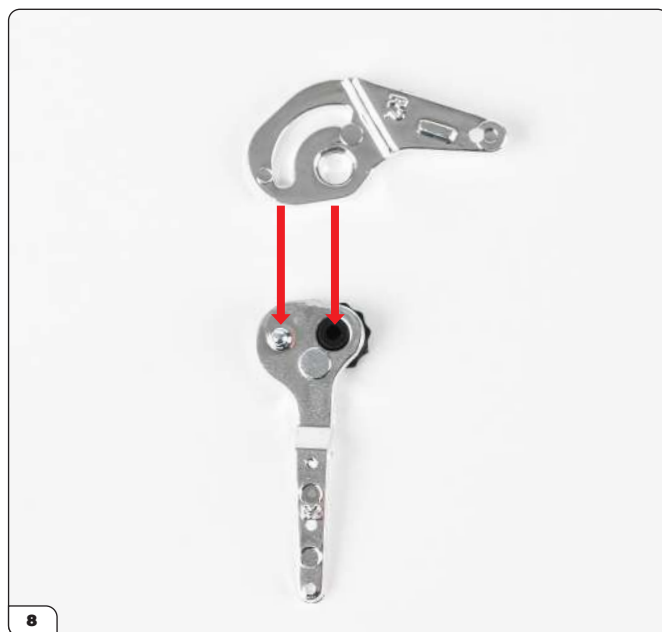

Align the backrest bracket as shown.

Stage 047: Assembling and Fitting the Driver Seat

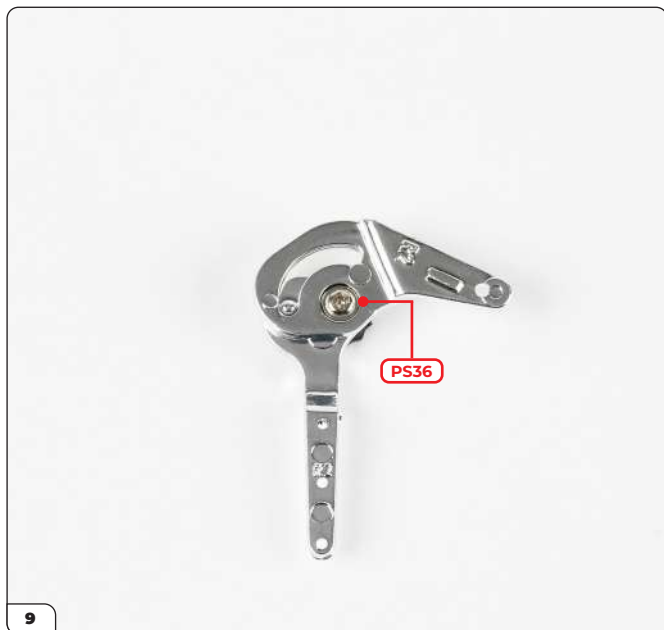

Fit the parts together and secure with a PS36 screw. Make sure not to overtighten the screw (see next step).



Check the parts can move freely. If the movement is stiff, loosen the screw slightly.

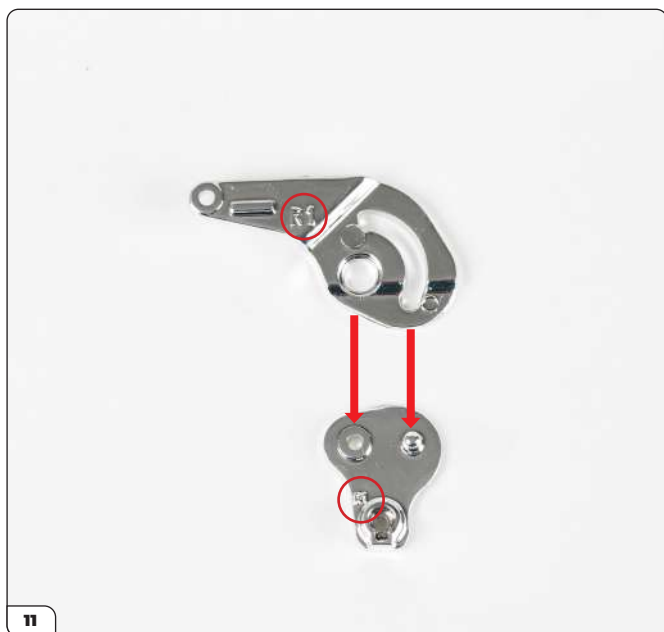

Take the other seat and backrest brackets marked 'R1' (47-D and 47-G) and align them as shown.



Fit the parts together and secure with a PS36 screw. Make sure not to overtighten the screw to allow the parts to move.

Stage 047: Assembling and Fitting the Driver Seat

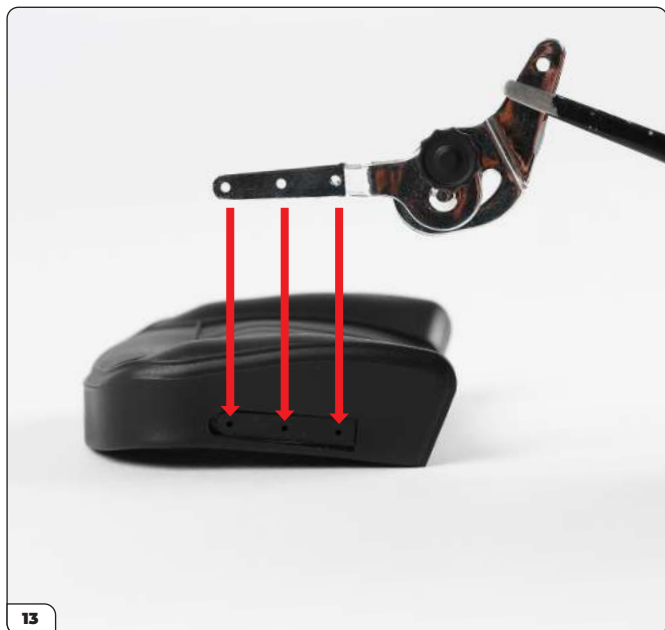

Align the adjuster bracket (step 10) with the three screw holes in the backrest as shown.



Secure the bracket using 3x PS21 screws.



Align the second backrest assembly (step 12) with the shaped screw hole on the other side.

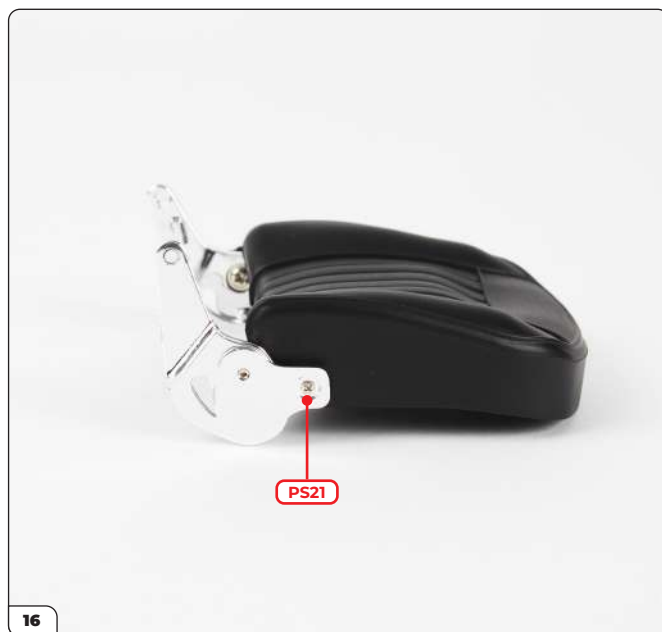

Secure with a PS21 screw.

Stage 047: Assembling and Fitting the Driver Seat



Align the brackets with the seat base (stage 046) as shown. Note the rectangular tabs on the brackets (inset) sit on top of the shaped screw holes on the base (red lines).



Fit the backrest in place then secure using 2x PS01 screws.



The brackets allow the backrest to be adjusted forwards and backwards.



The backrest can also be folded down.

Stage 047: Assembling and Fitting the Driver Seat

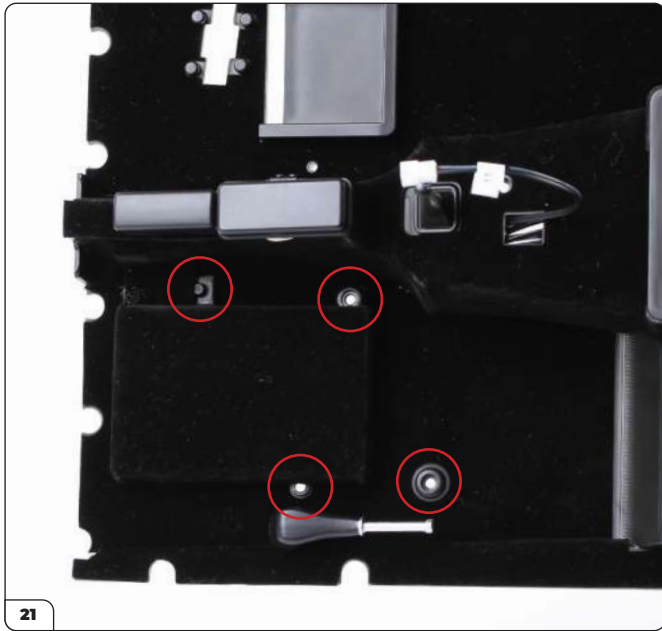

The seat is mounted onto these four points on the cockpit floor.

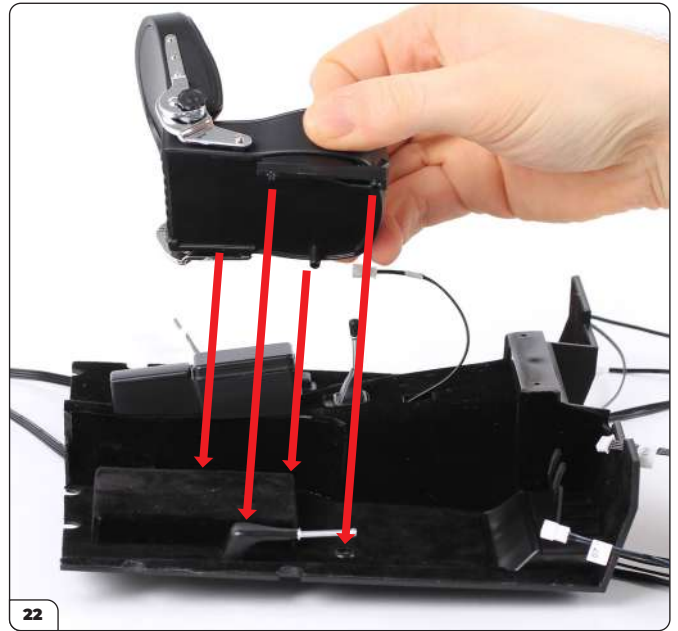

Align the seat with the cockpit floor.



Fit the seat onto the four mounting points.

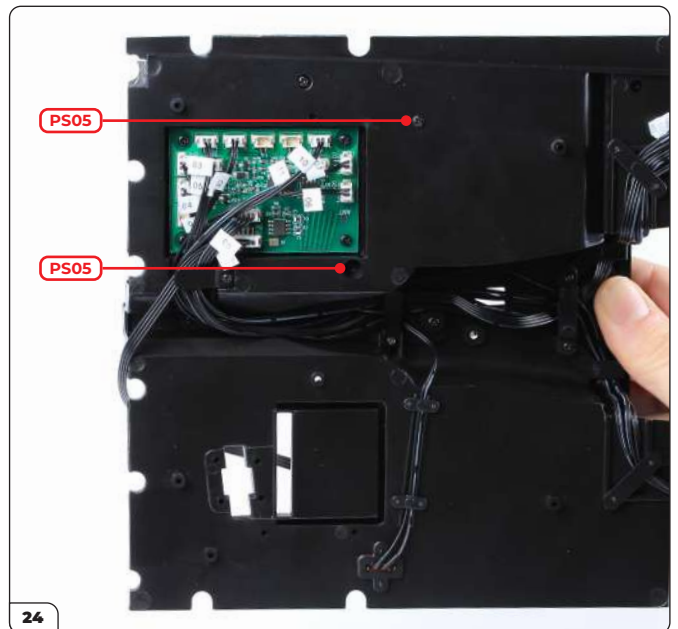

Hold the seat in place then secure from underneath with 2x PS05 screws.

Stage 047: Assembling and Fitting the Driver Seat

STAGE COMPLETE

