

LEOPARD 2A6

MAIN BATTLE TANK



Pack 12

BUILD INSTRUCTIONS

AGORA
MODELS

LEOPARD 2A6

MAIN BATTLE TANK



EN: Align the parts and press firmly on the lugs until the parts fit tightly together.

FR: Alignez les pièces et appuyez fermement sur les ergots jusqu'à ce que les pièces s'emboîtent étroitement.

DE: Richten Sie die Teile aus und drücken Sie fest auf die Nasen, bis die Teile fest zusammenpassen.

ES: Alinee las piezas y presione firmemente hasta que encajen bien.

RU: Совместите детали и сильно надавите на выступы, пока детали не будут плотно прилегать друг к другу.



EN: Be careful not to over tighten the screws.

FR: Attention à ne pas trop serrer les vis.

DE: Achten Sie darauf, die Schrauben nicht zu fest anzuziehen.

ES: Tenga cuidado de no apretar demasiado los tornillos.

RU: Будьте осторожны, не затягивайте винты слишком сильно.



EN: Pay particular attention to the orientation of the parts.

FR: Portez une attention particulière à l'orientation des pièces.

DE: Achten Sie besonders auf die Ausrichtung der Teile.

ES: Preste especial atención a la orientación de las piezas.

RU: Обратите особое внимание на ориентацию деталей.



EN: Remove screws as indicated

FR: Retirez les vis comme indiqué

DE: Schrauben wie angegeben entfernen

ES: Quite los tornillos como se indica

RU: Удалите винты, как показано



EN: Use a hammer to fit these parts.

FR: Utilisez un marteau pour ajuster ces pièces.

DE: Verwenden Sie einen Hammer, um diese Teile zu montieren.

ES: Utilice un martillo para colocar estas piezas.

RU: Используйте молоток, чтобы установить эти детали.



EN: Save for later

FR: Garder pour plus tard

DE: Für später speichern

ES: Guardar para más adelante

RU: Сохранить на потом



EN: Use superglue

FR: Utiliser de la superglue

DE: Sekundenkleber verwenden

ES: Usa superpegamento

RU: Используйте суперклей



EN: Water required

FR: Eau nécessaire

DE: Wasser erforderlich

ES: Agua requerida

RU: Требуется вода



EN: Click to watch the video

FR: Cliquez pour regarder la vidéo

DE: Klicken Sie hier, um das Video anzusehen

ES: Click para ver el video

RU: Кликните, чтобы посмотреть видео

LEOPARD 2A6

MAIN BATTLE TANK



L x79

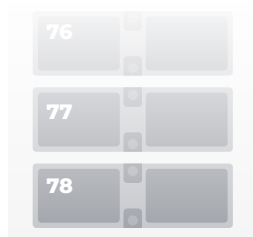
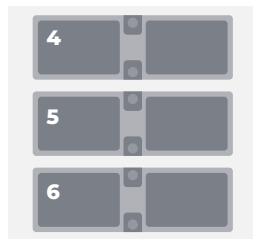
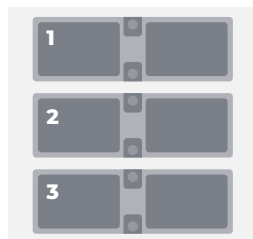

R x79

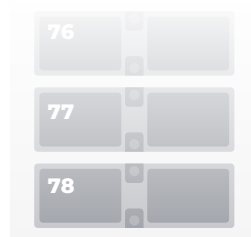
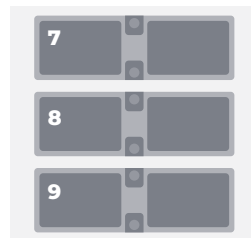
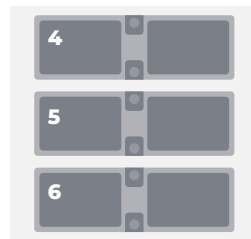
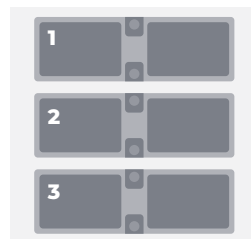

EN: +5 Spares DE: +5 Ersatzschraube FR: +5 Pièce de rechange ES: +5 Repuestos
RU: +5 запчасти



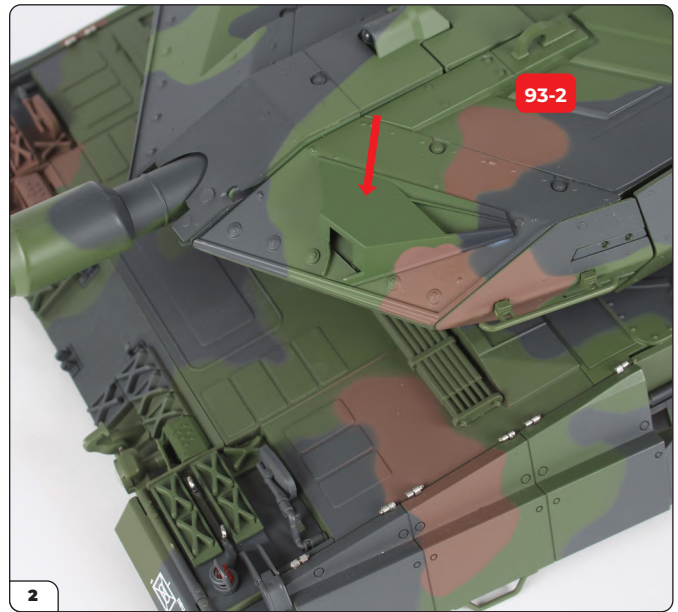

STAGE COMPLETE



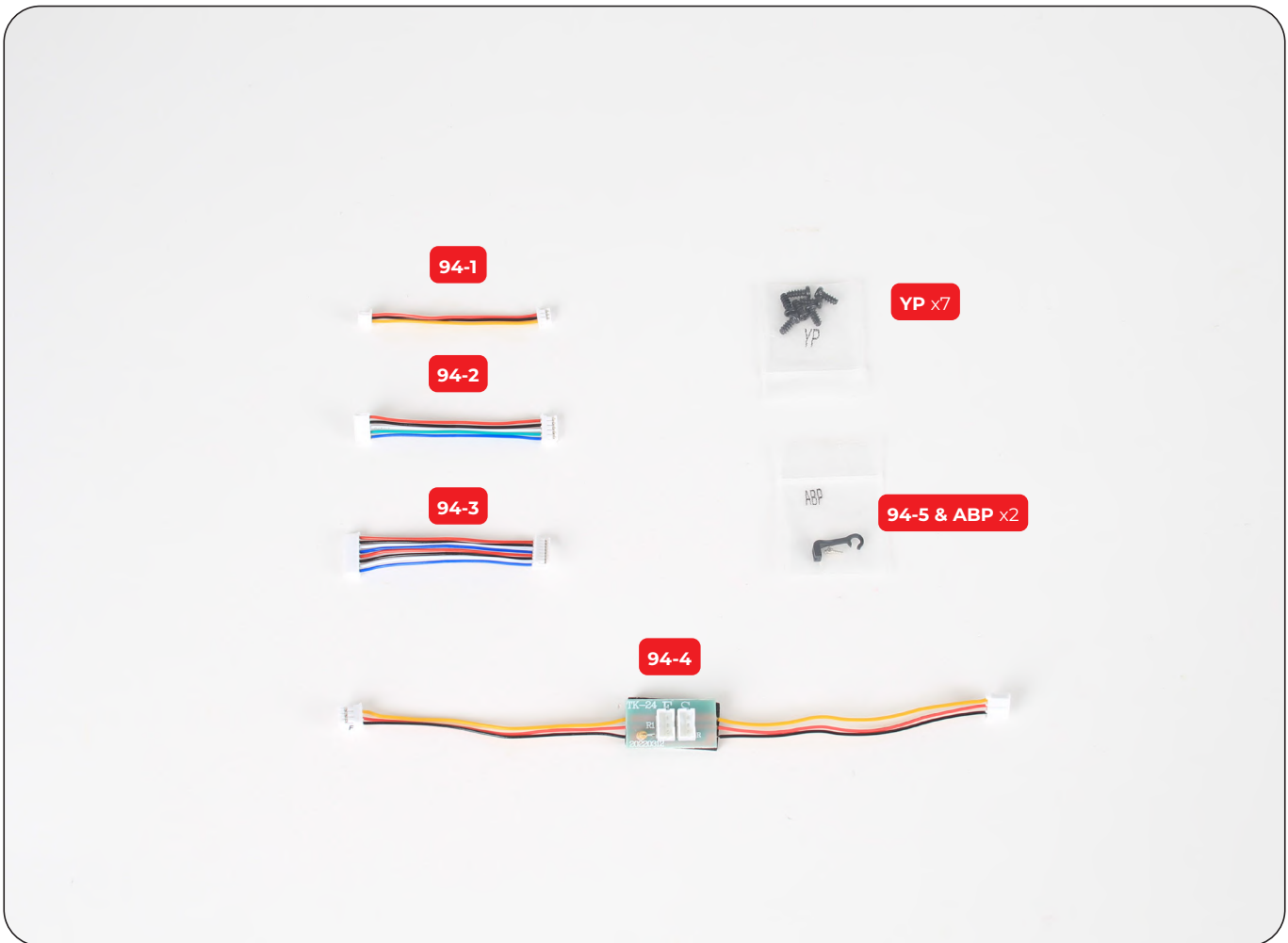

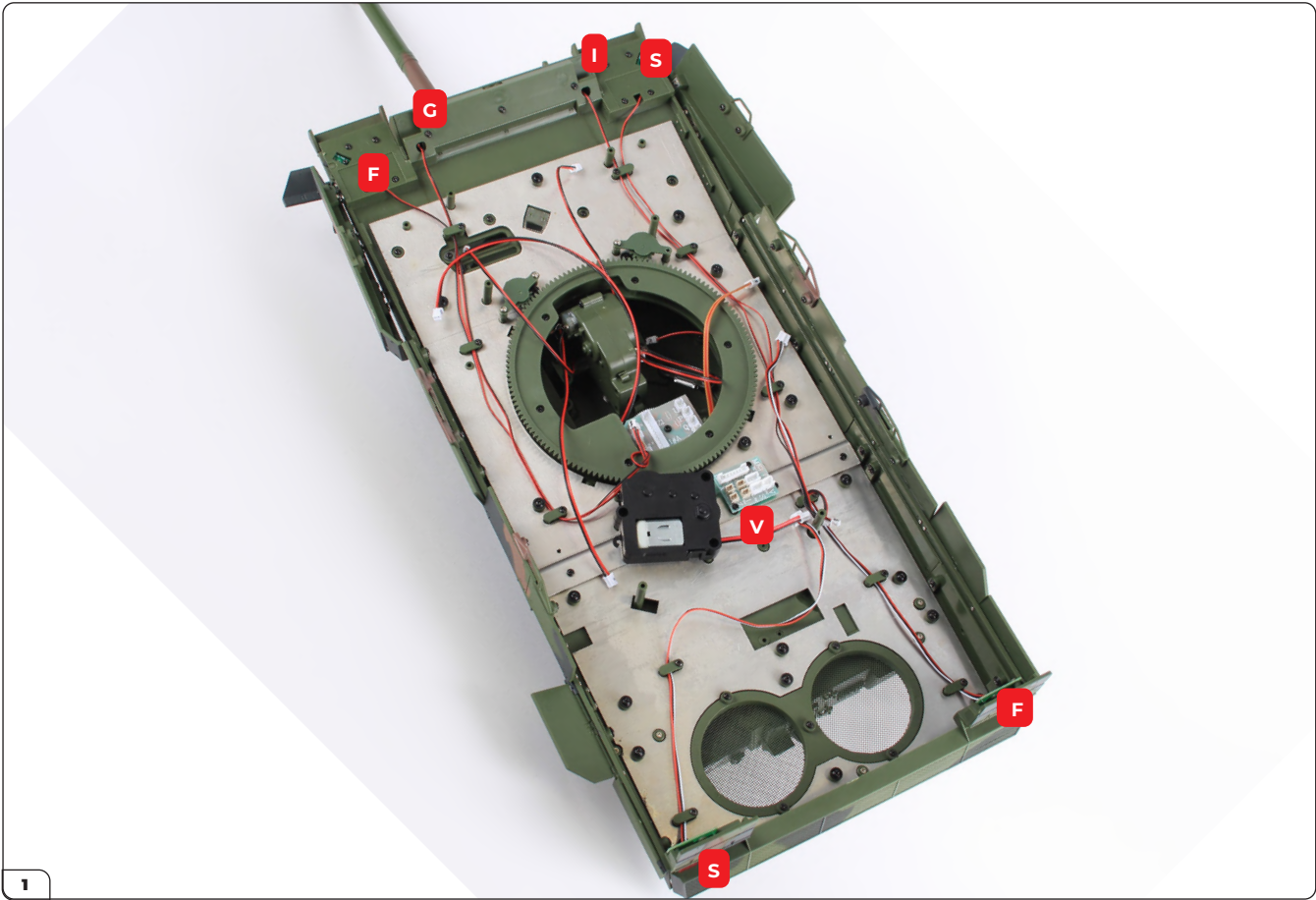

Check you have the new circuit board 75-1 included in pack 13.

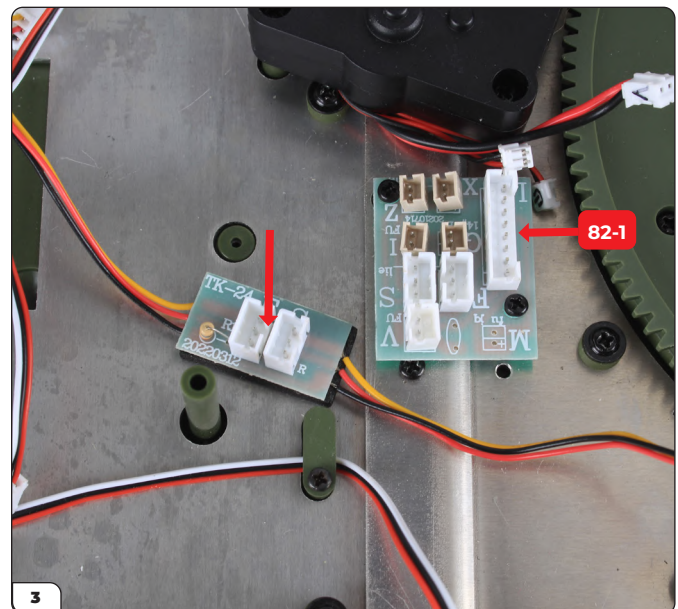
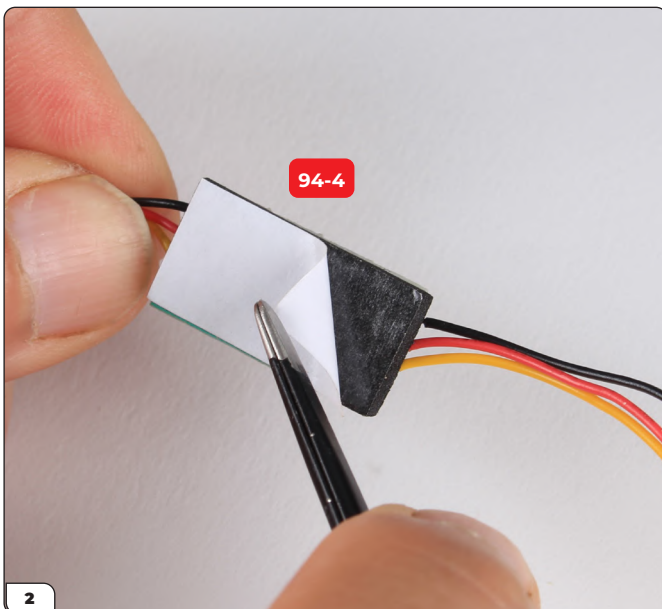

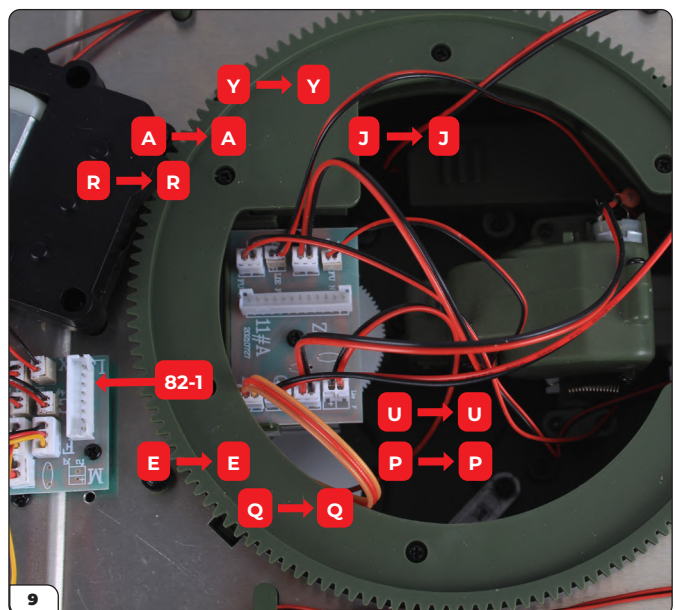
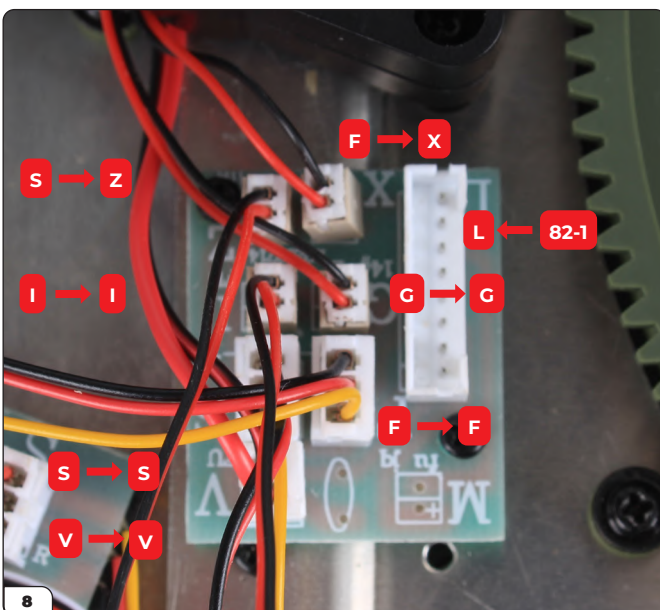
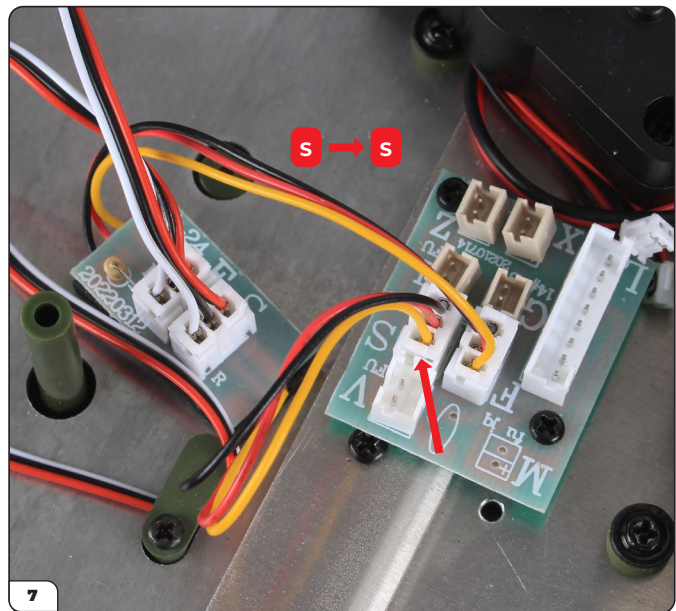
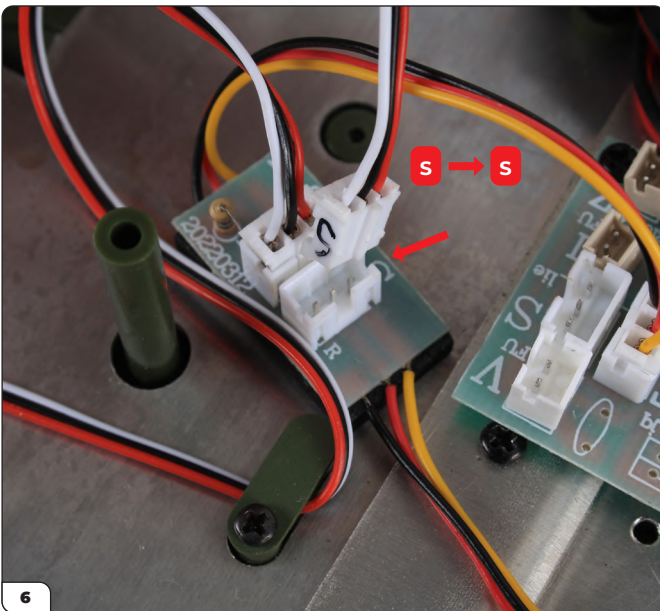
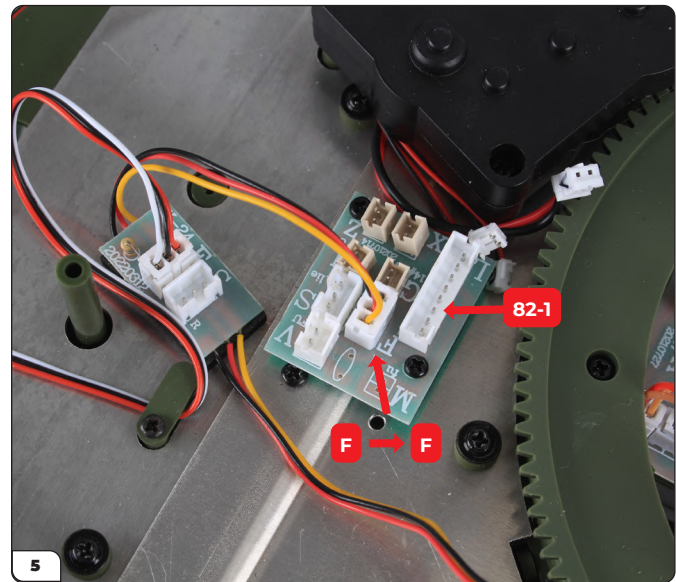
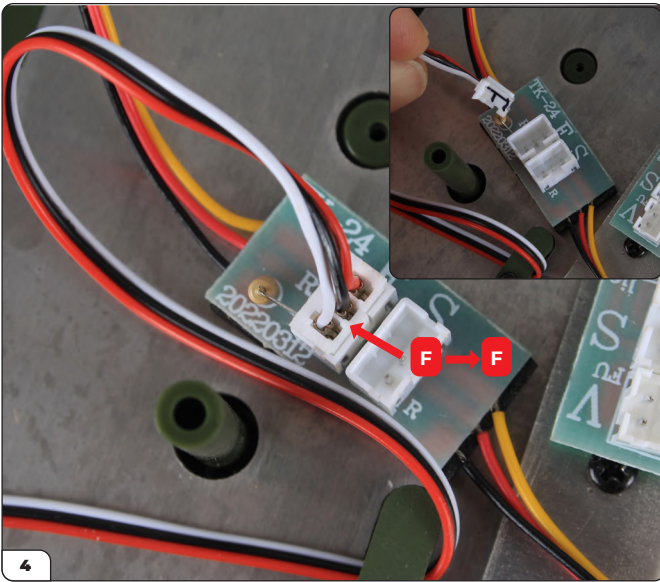

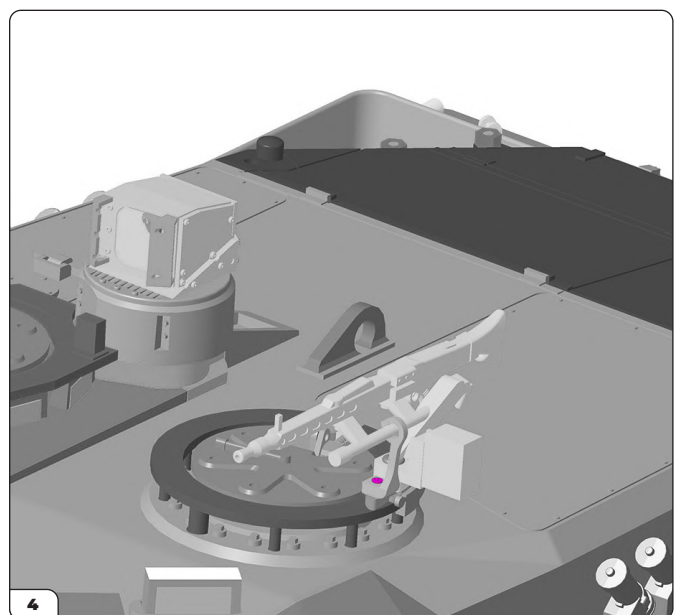
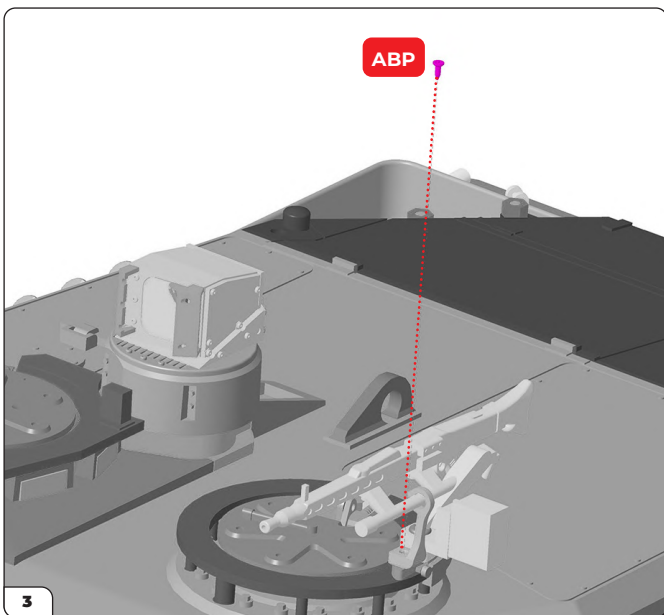
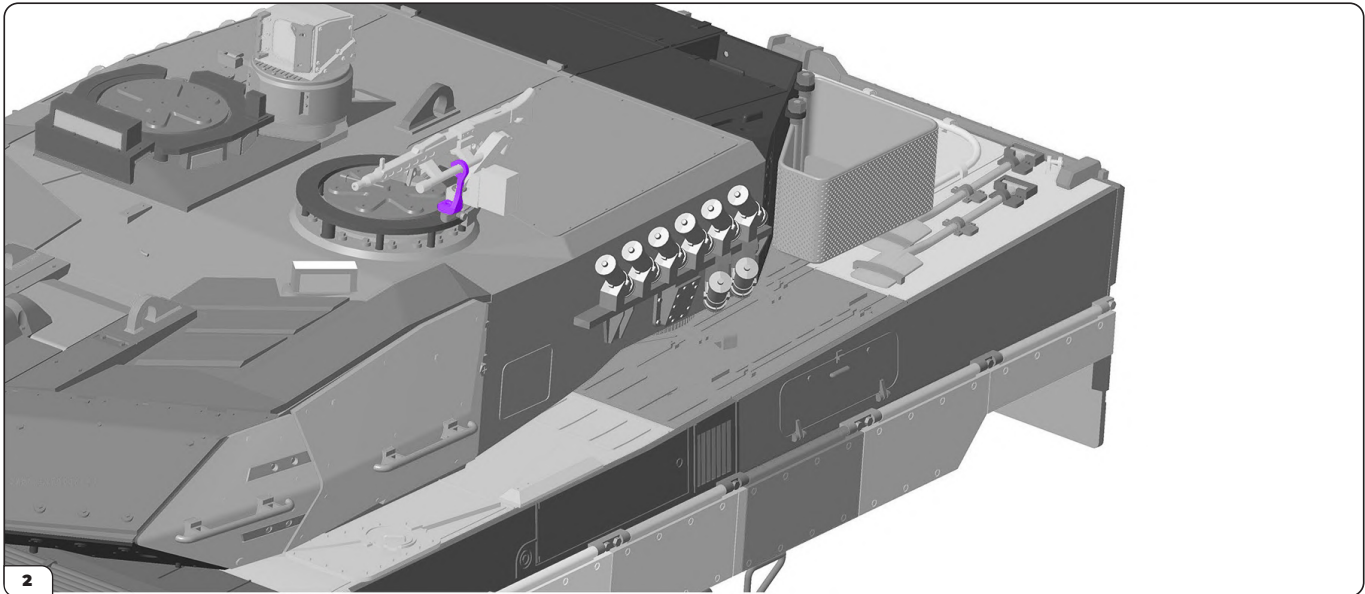
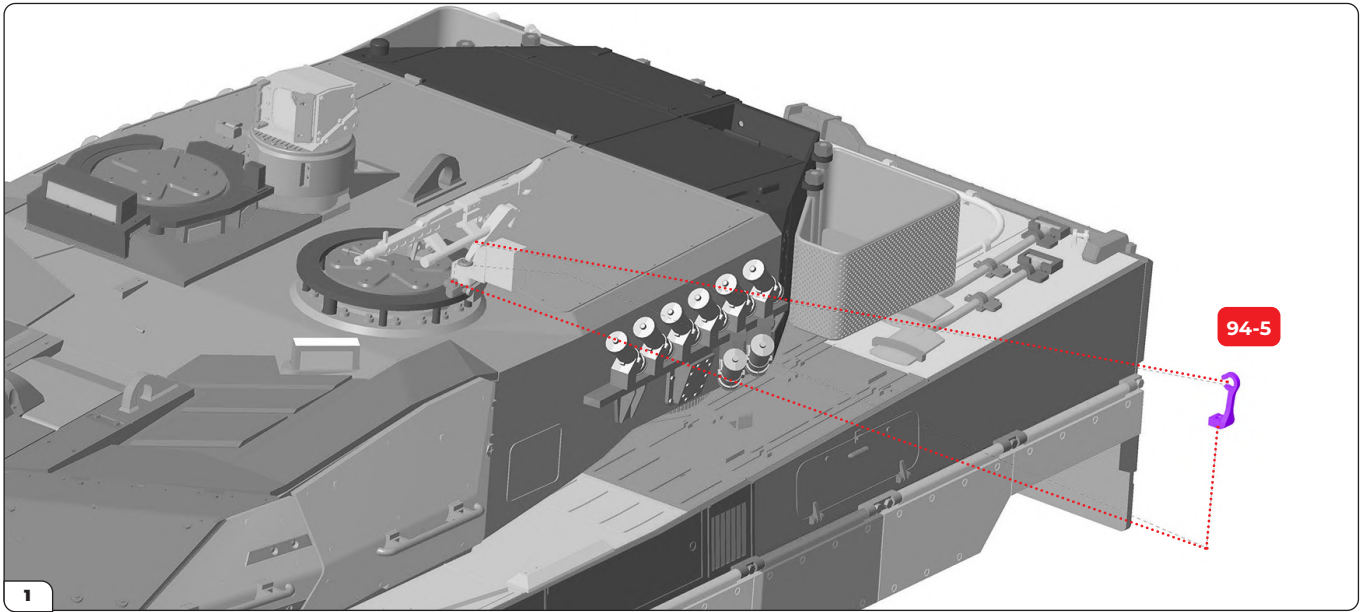

94 Springs

If you have already fitted the new springs supplied with pack 13, go straight to page 13.

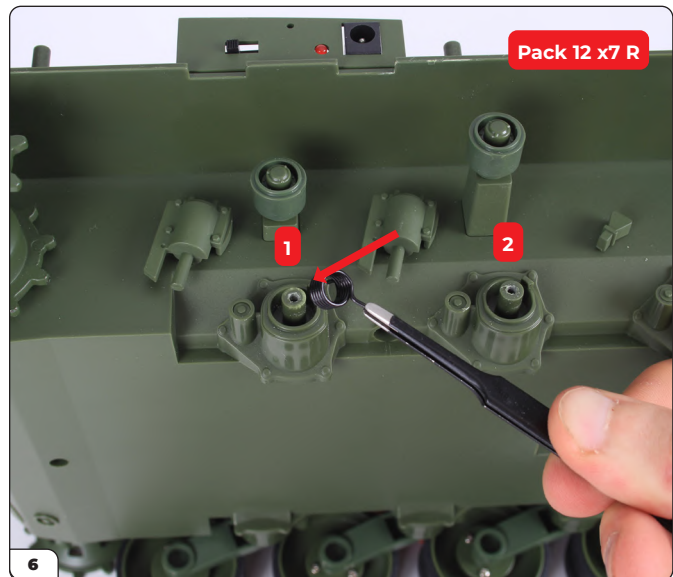
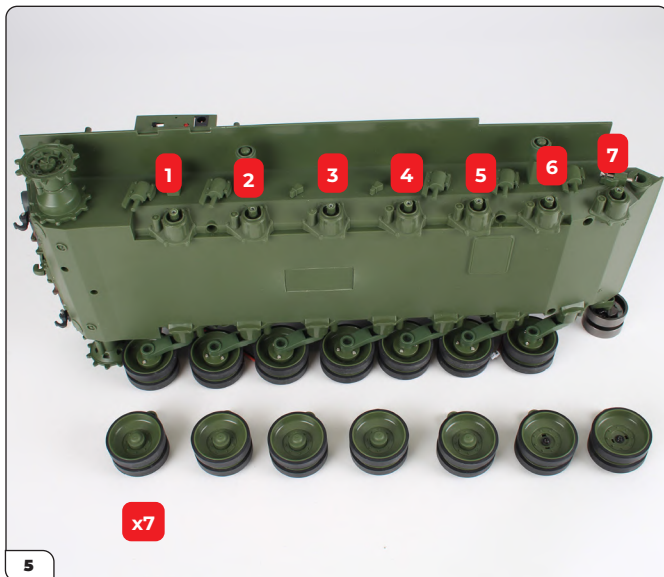
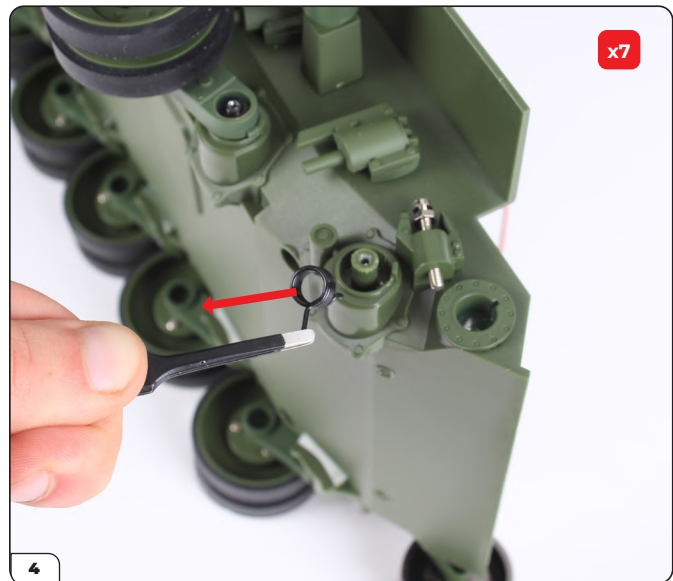
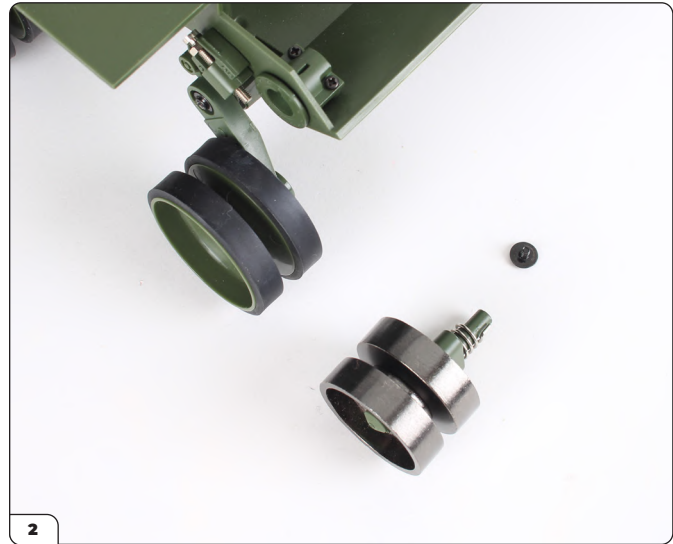
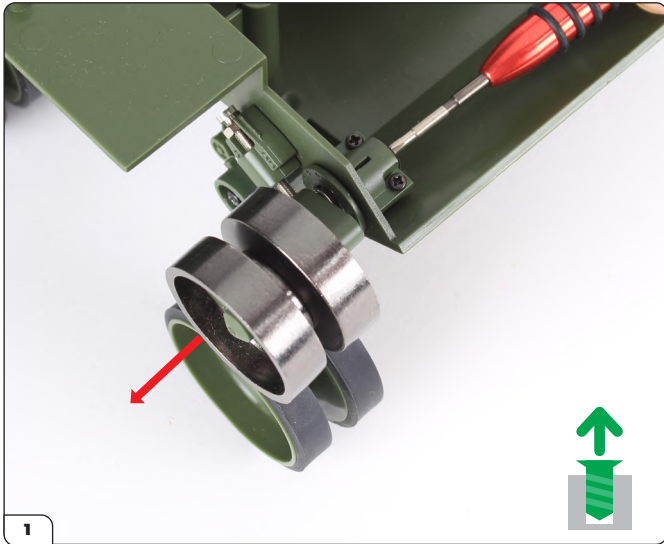

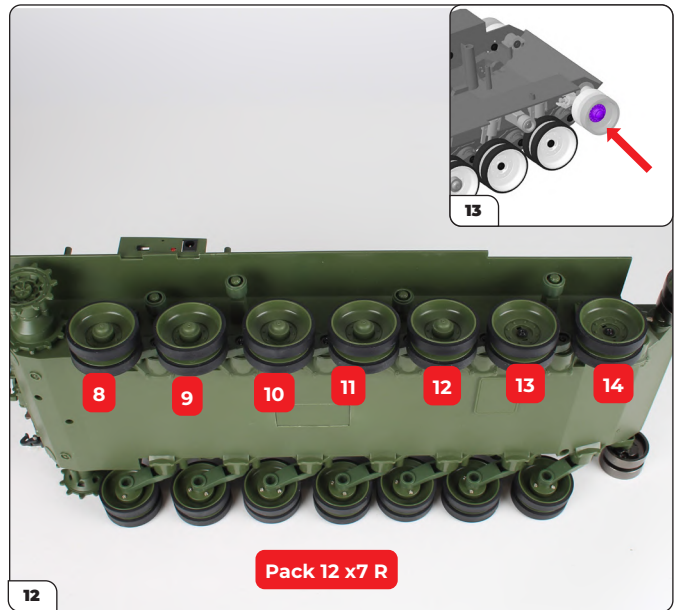
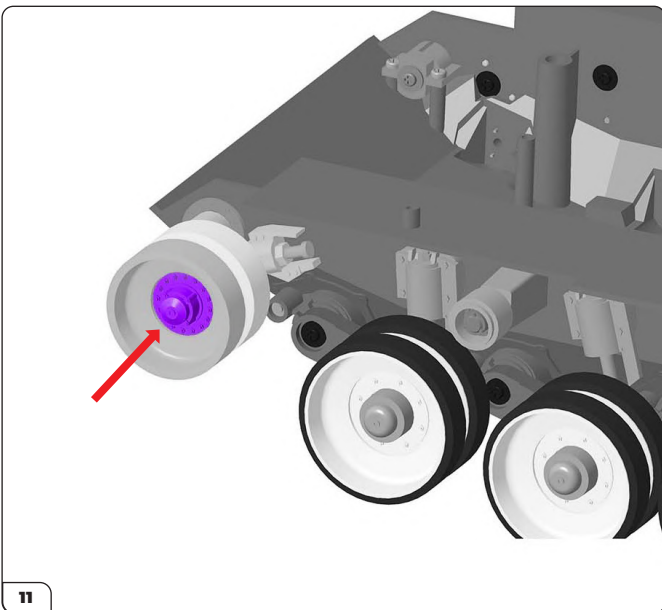
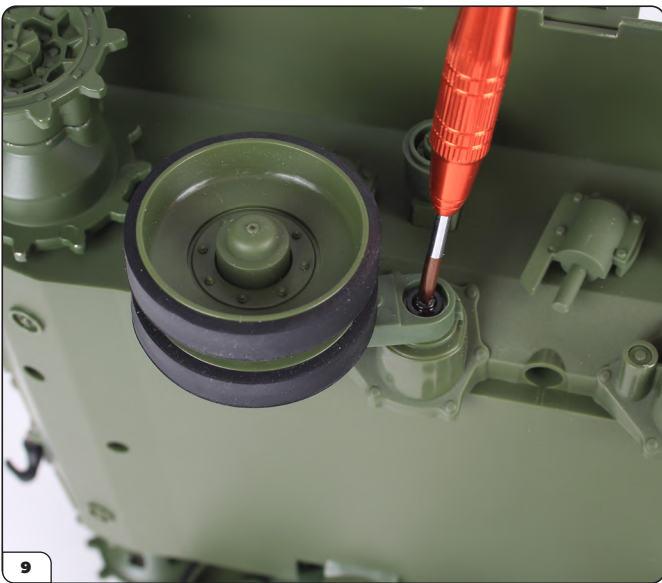
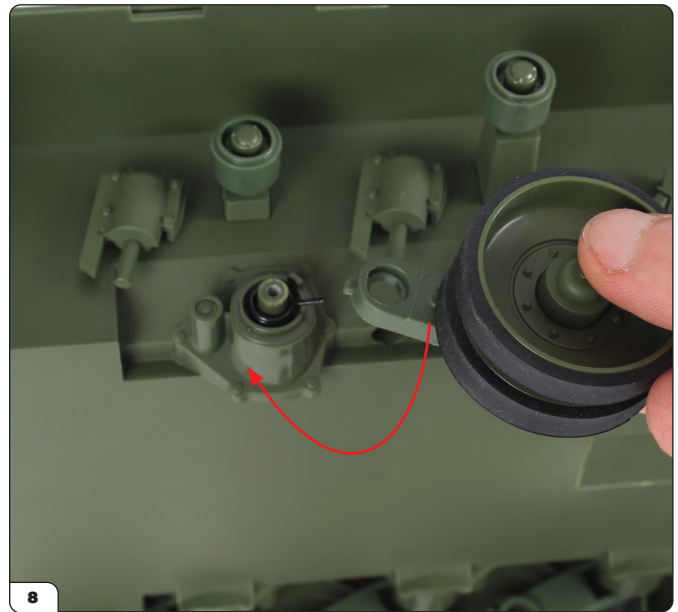
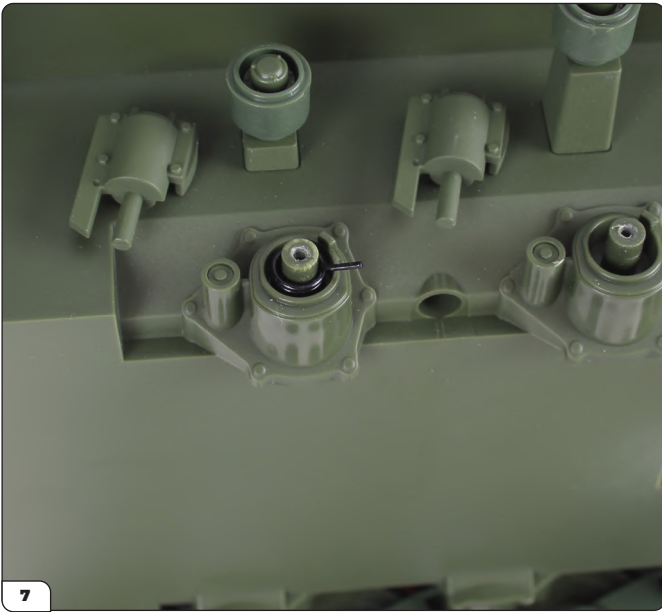

94

There should be 79 links on each track. Follow the steps below if you need to remove any links.

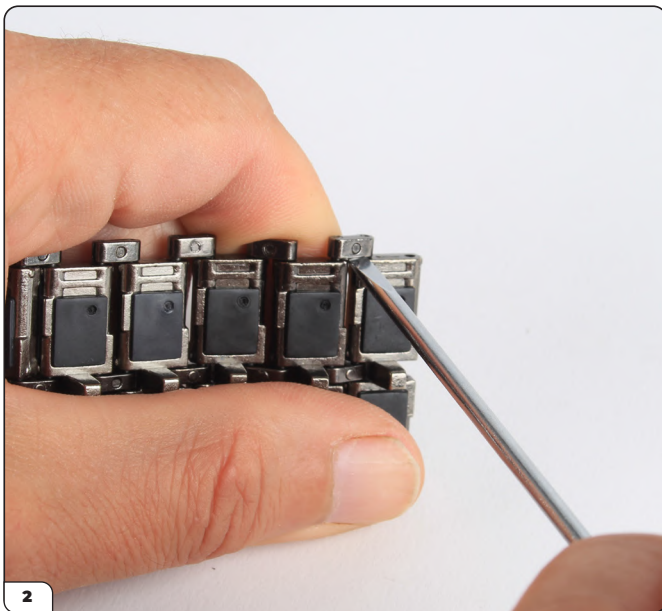

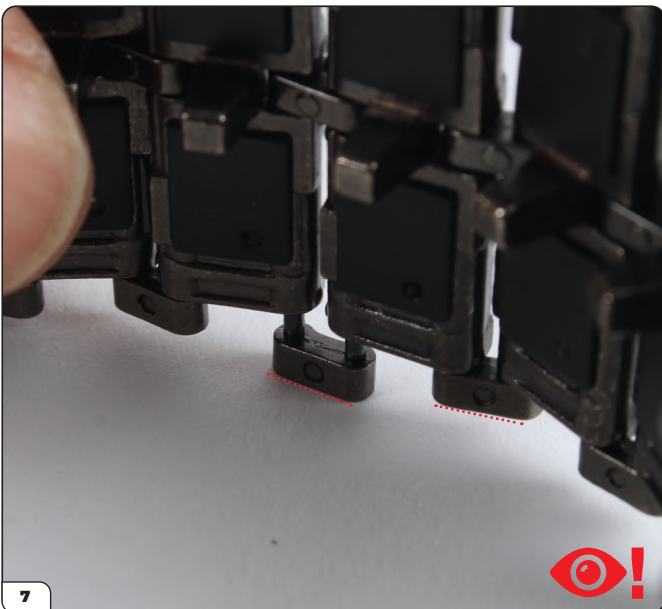
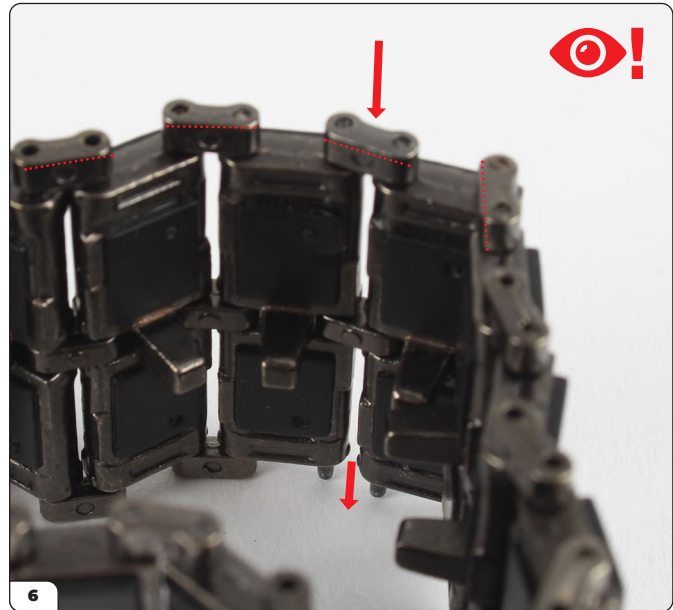
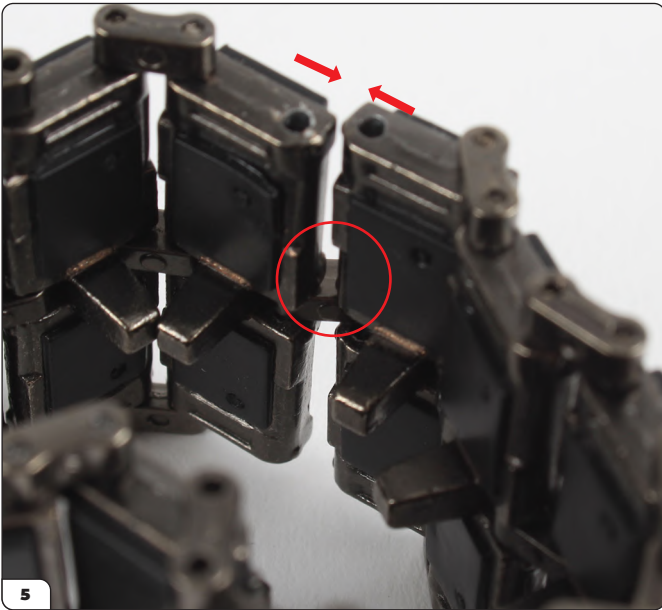

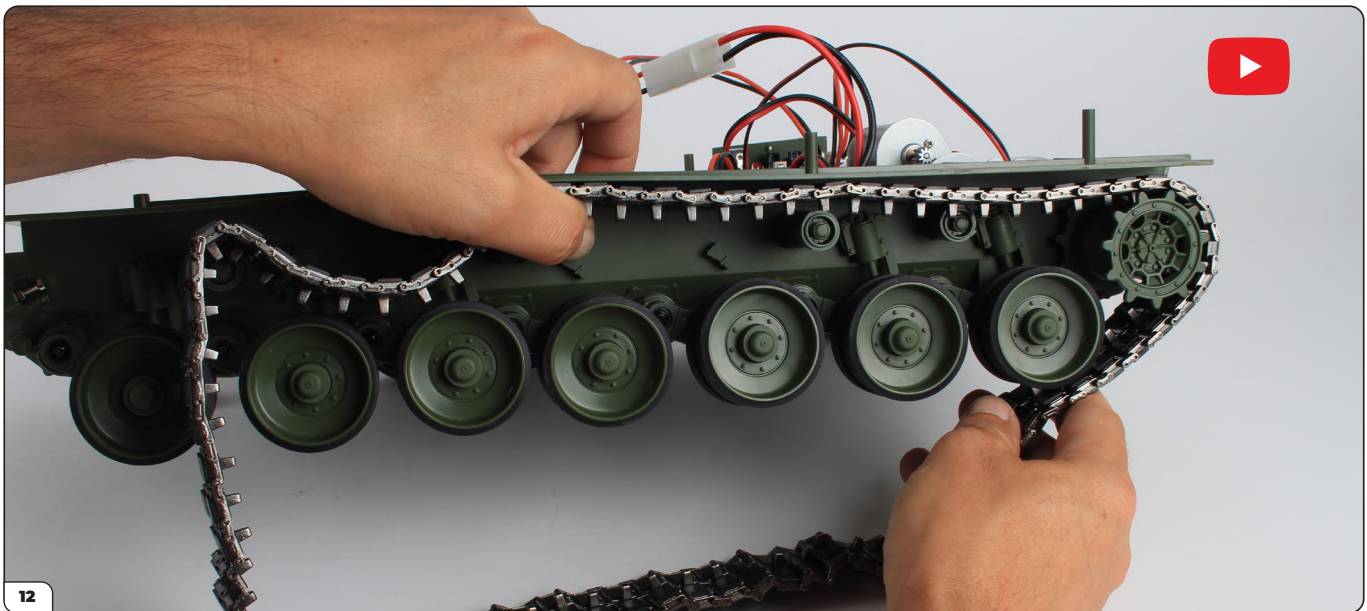
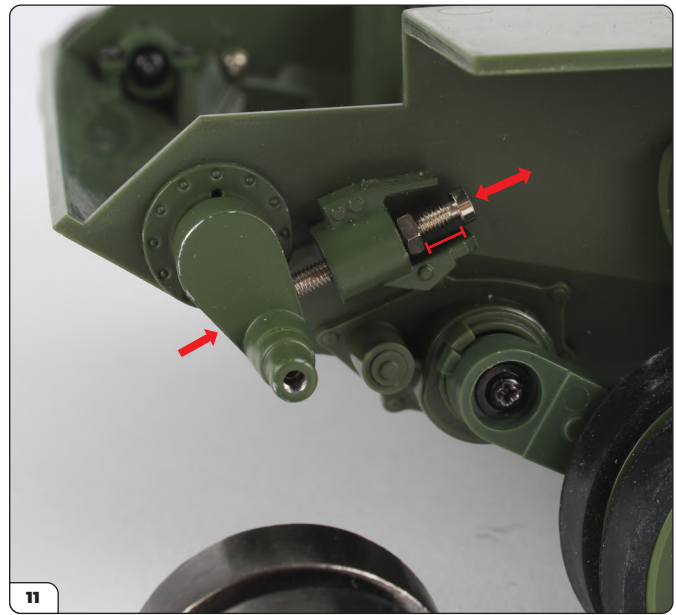
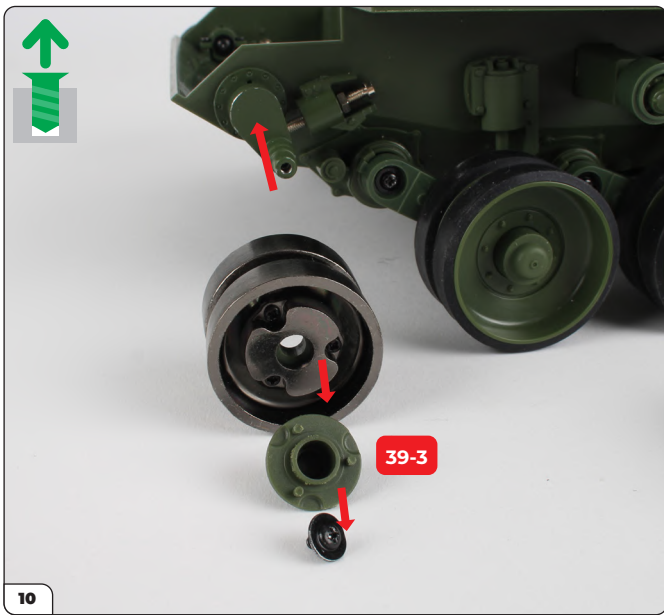

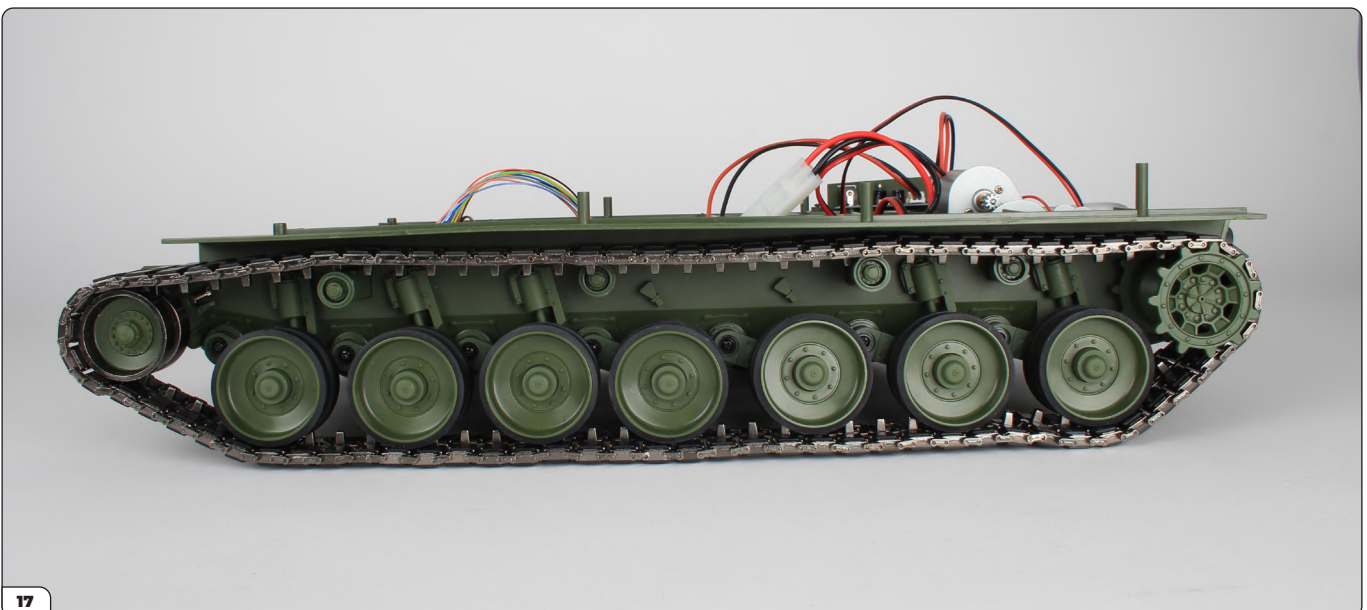
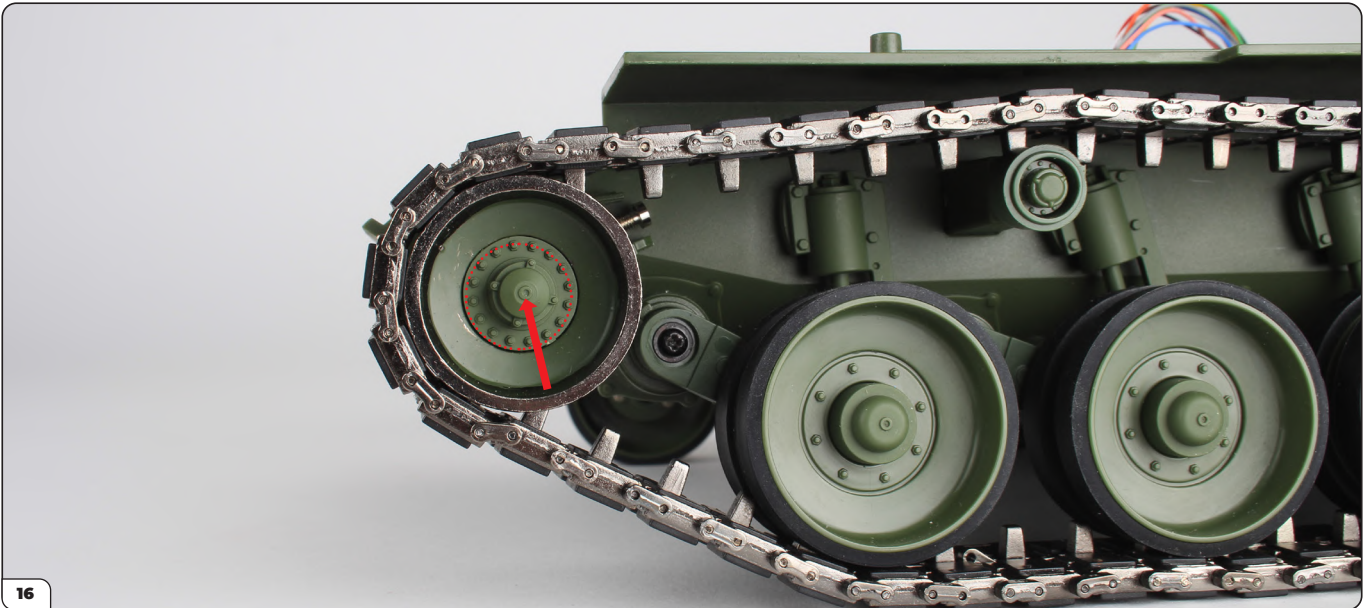
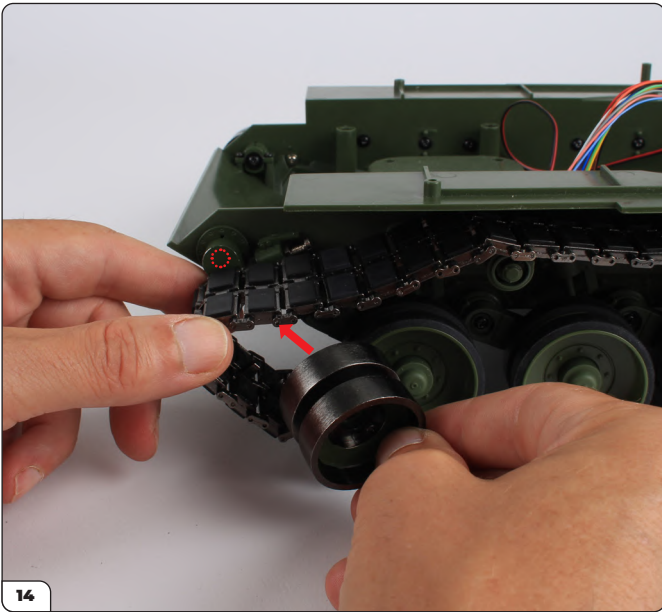

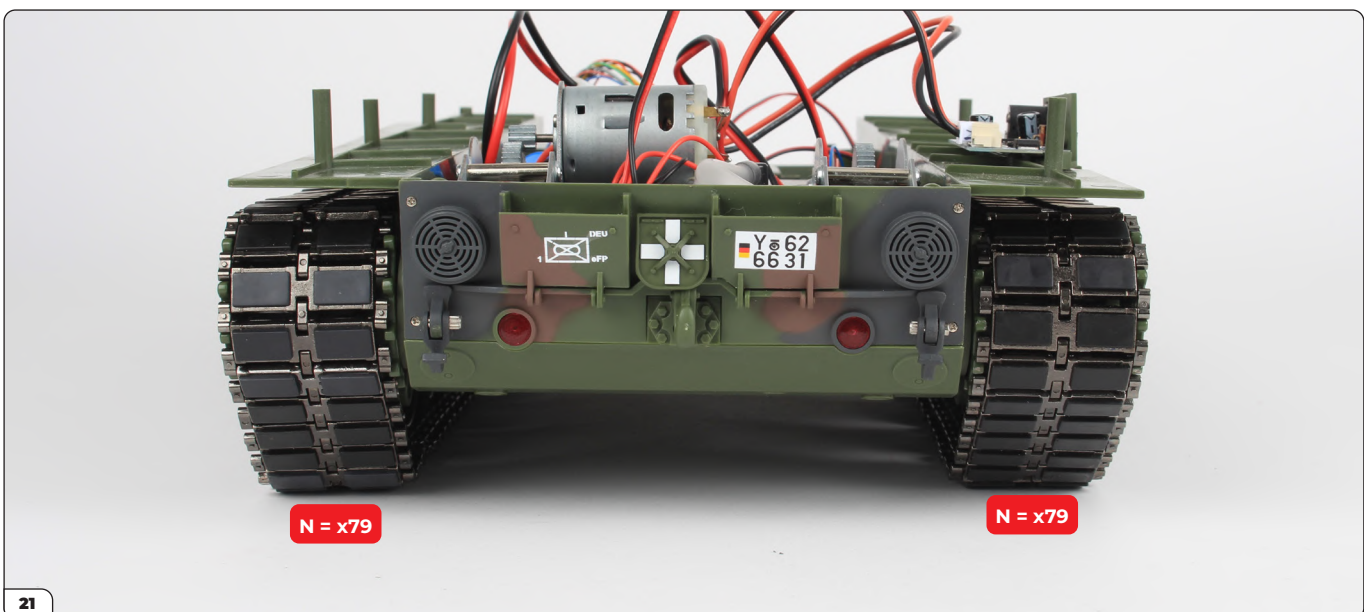
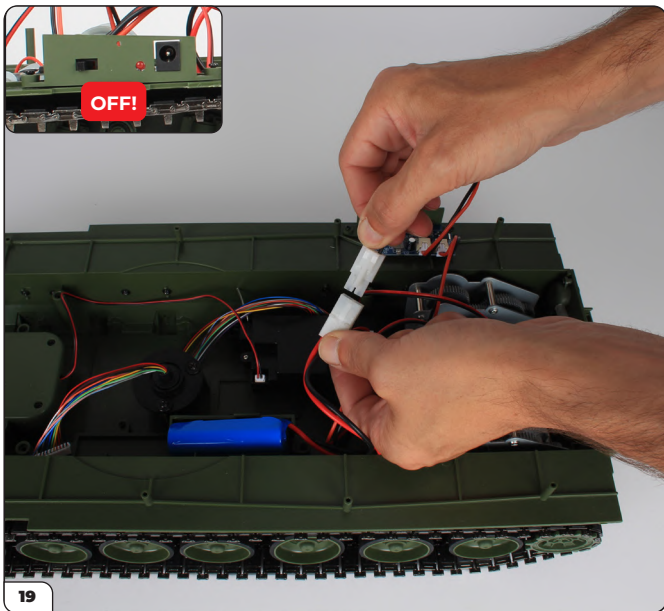
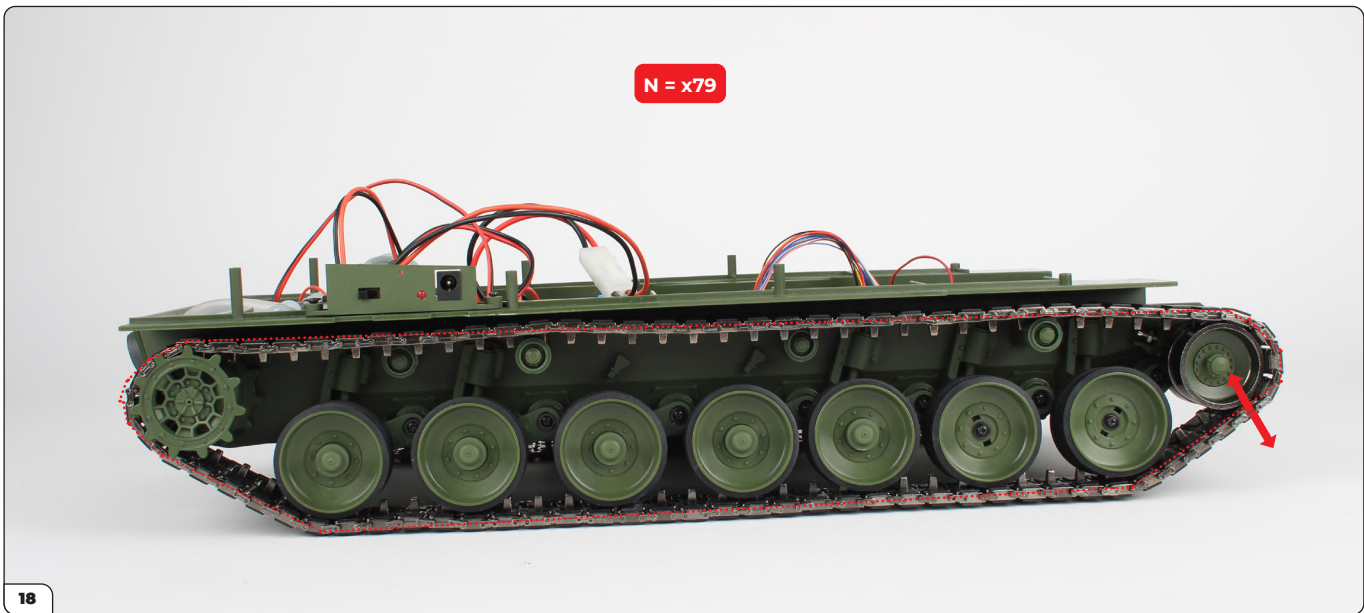

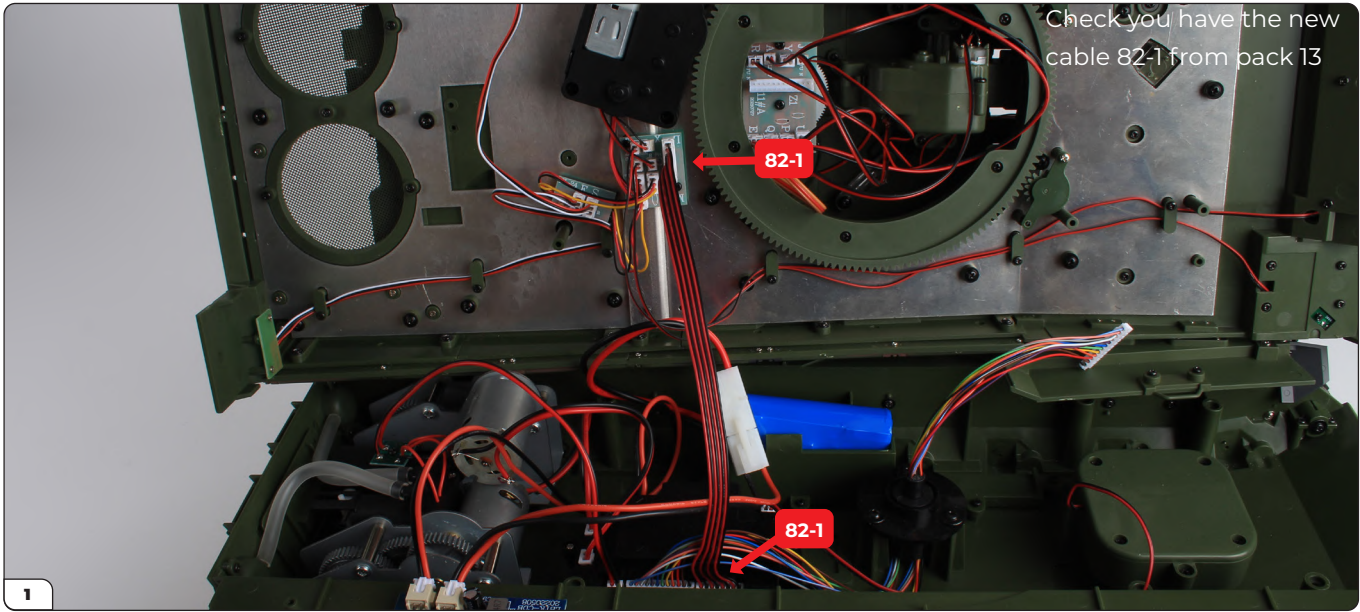

Check you have the new cable 82-1 from pack 13

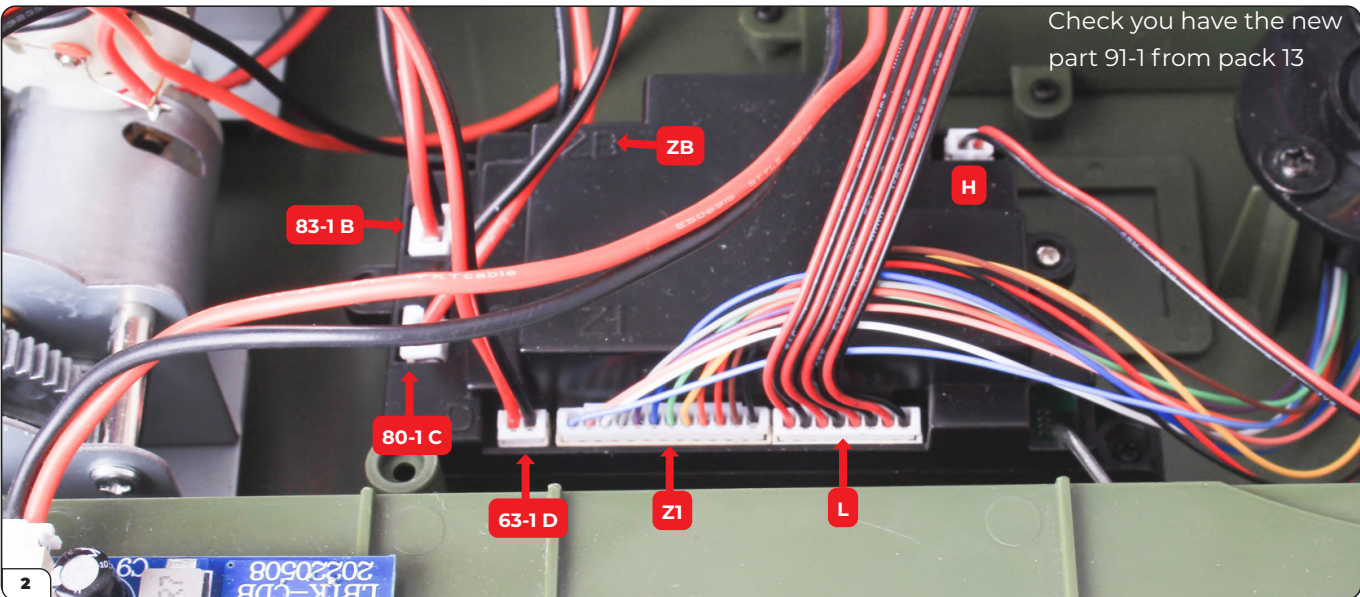

Check you have the new part 91-1 from pack 13

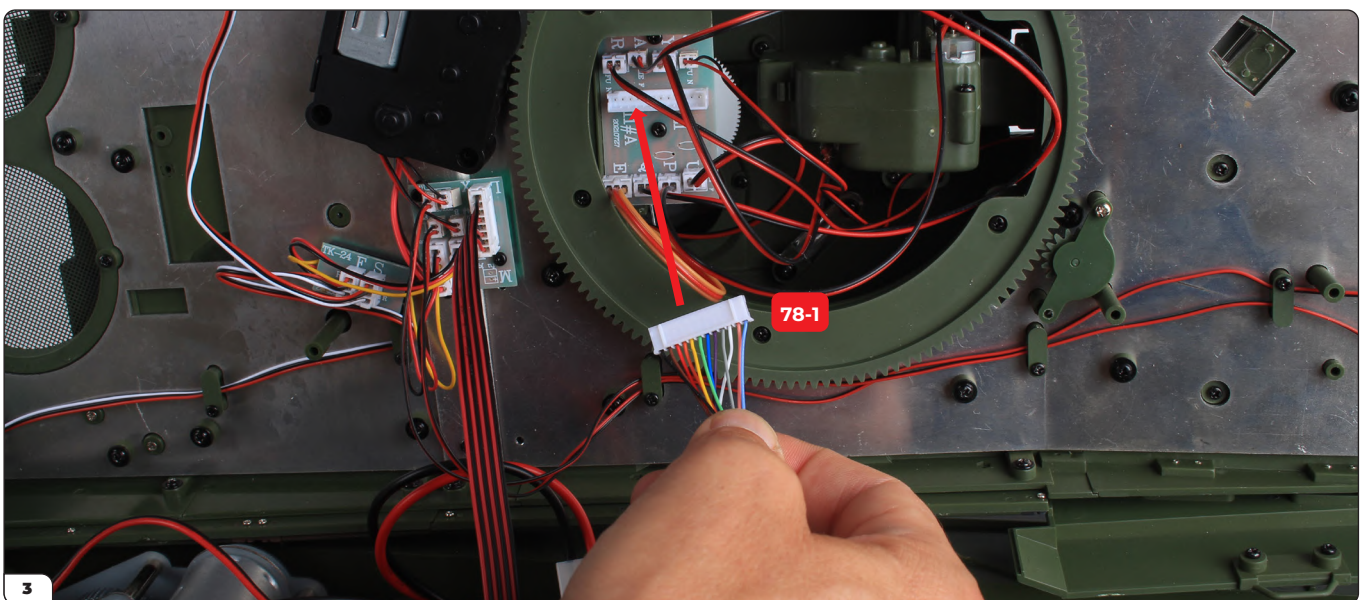

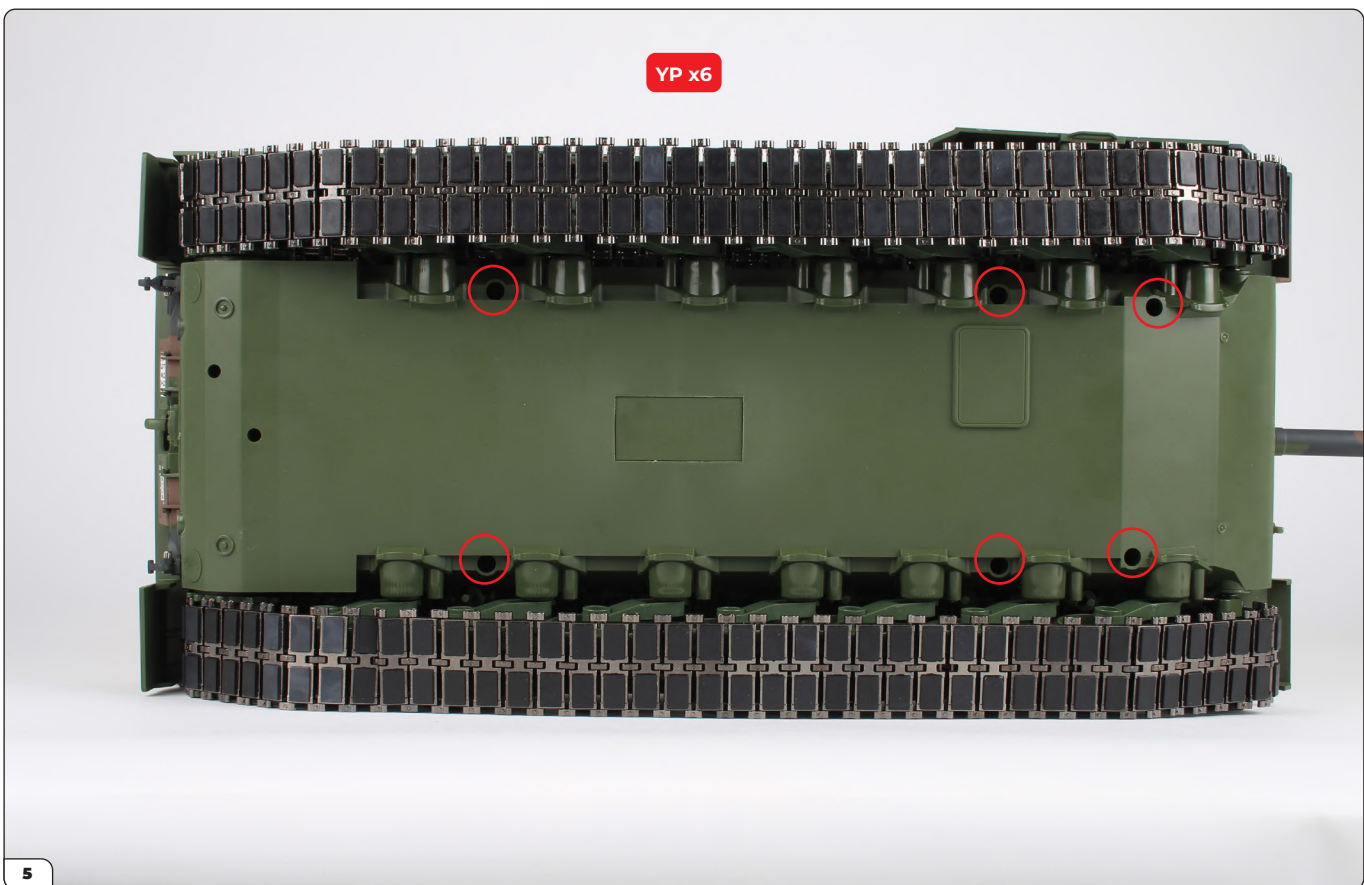
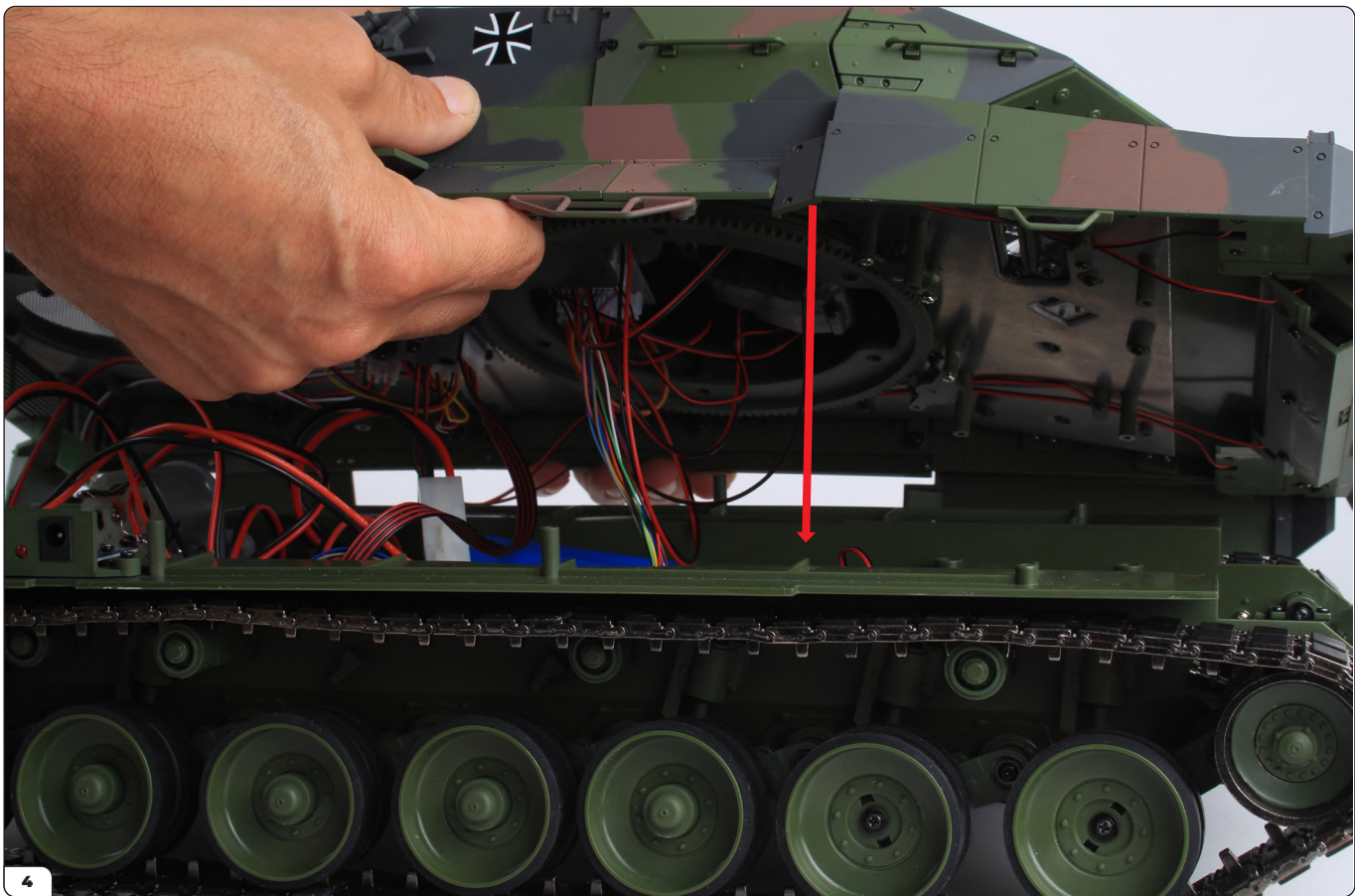

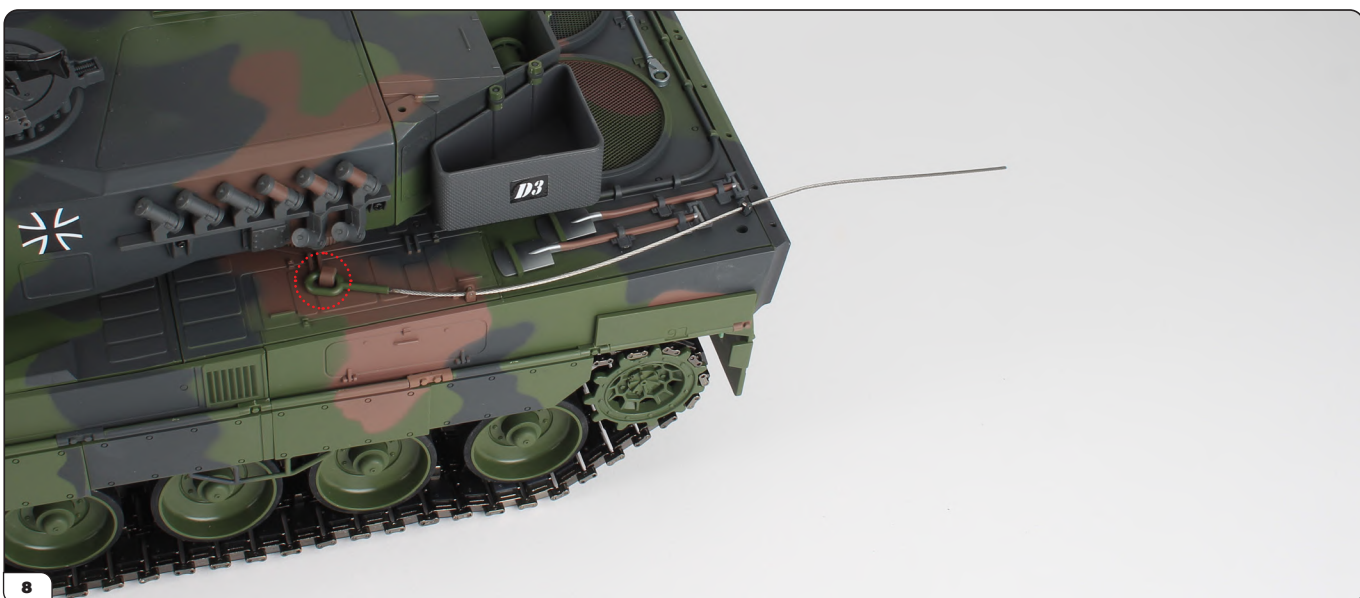

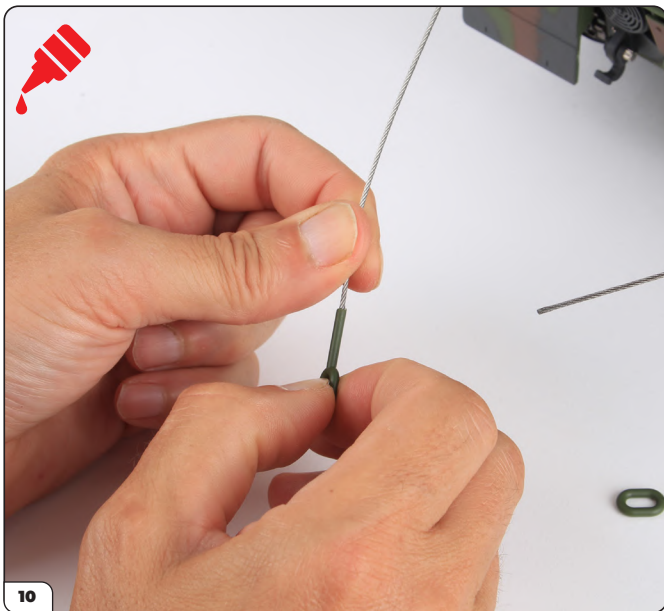

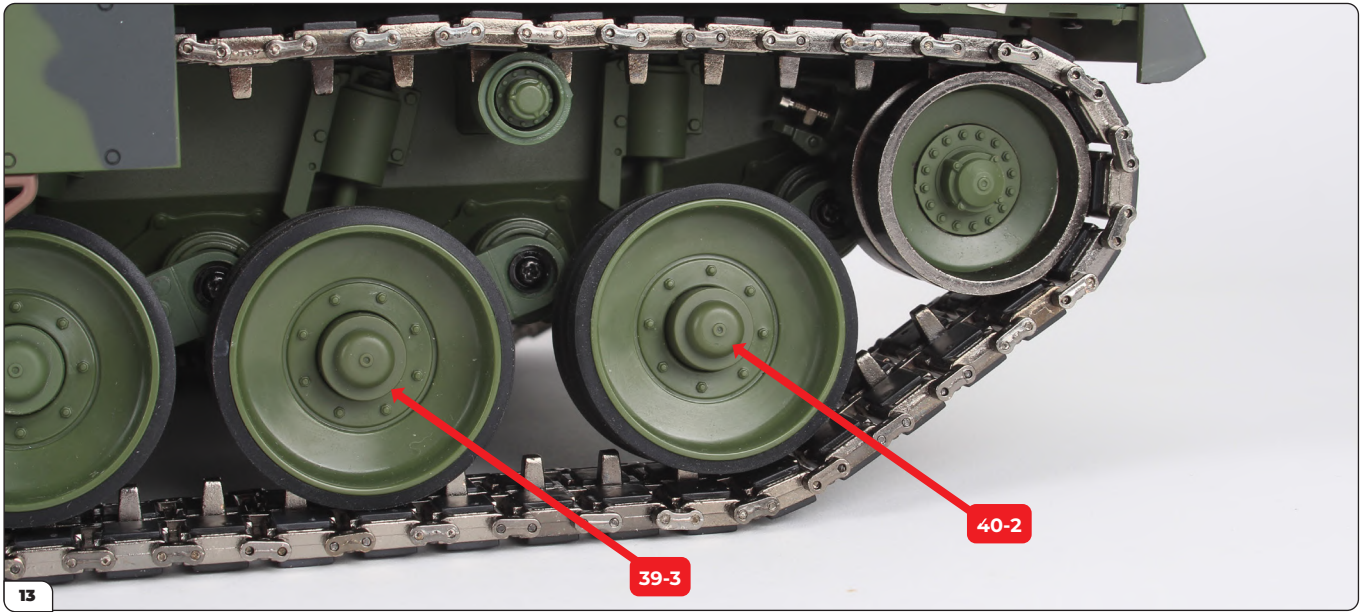

94 Leopard complete!

STAGE COMPLETE







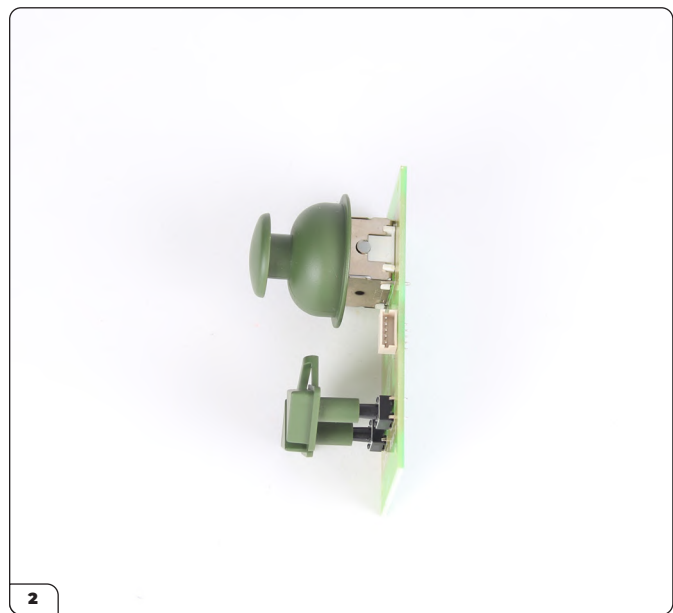

STAGE COMPLETE

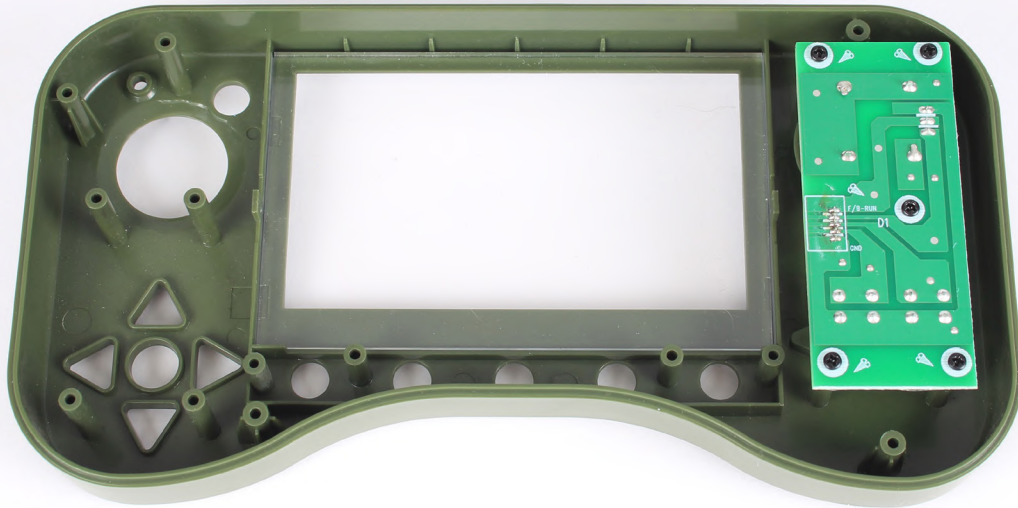

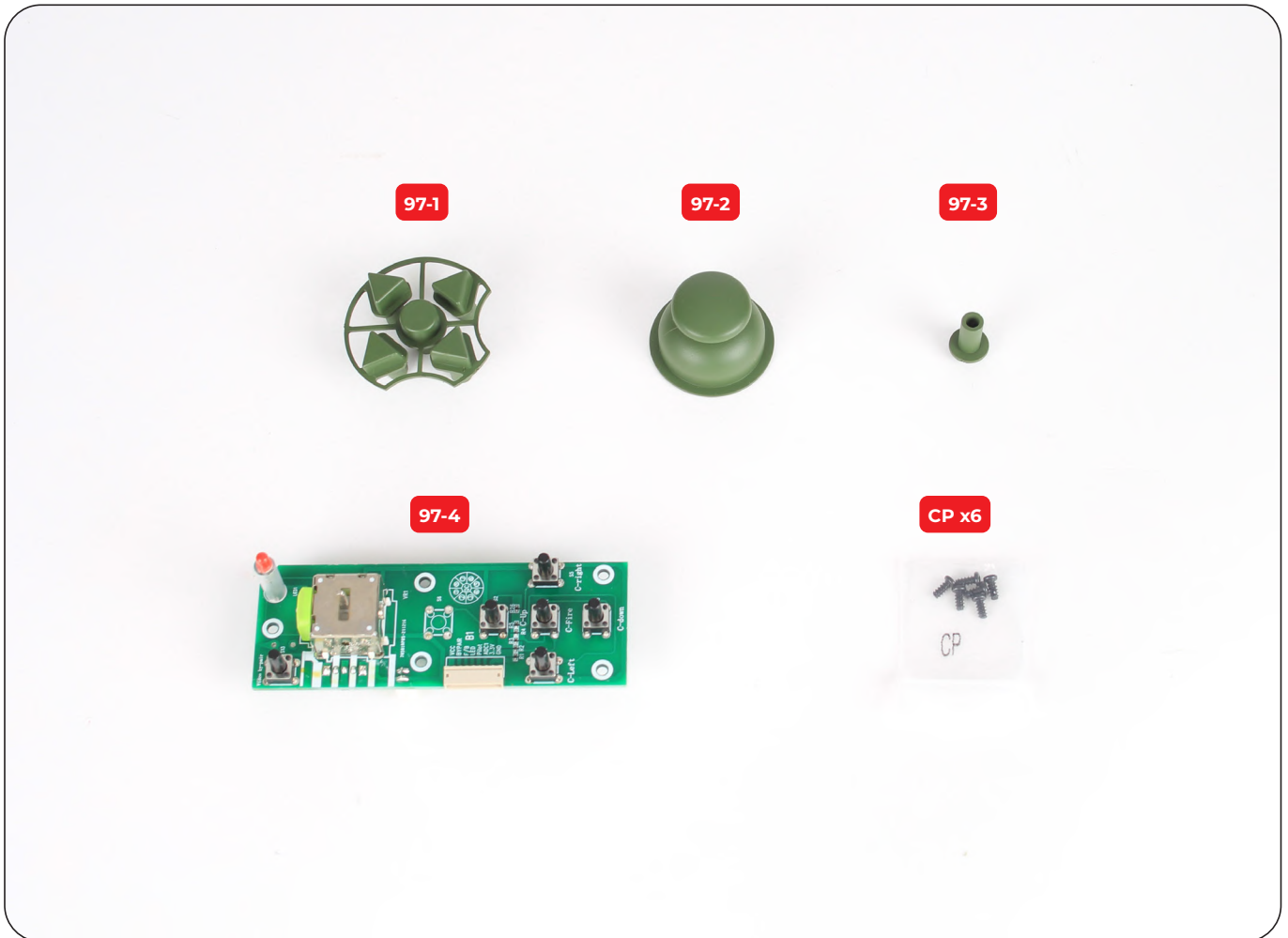

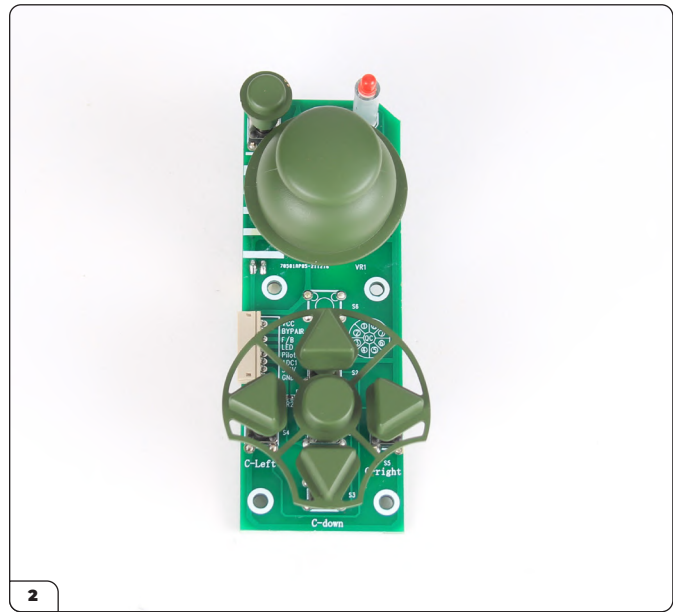
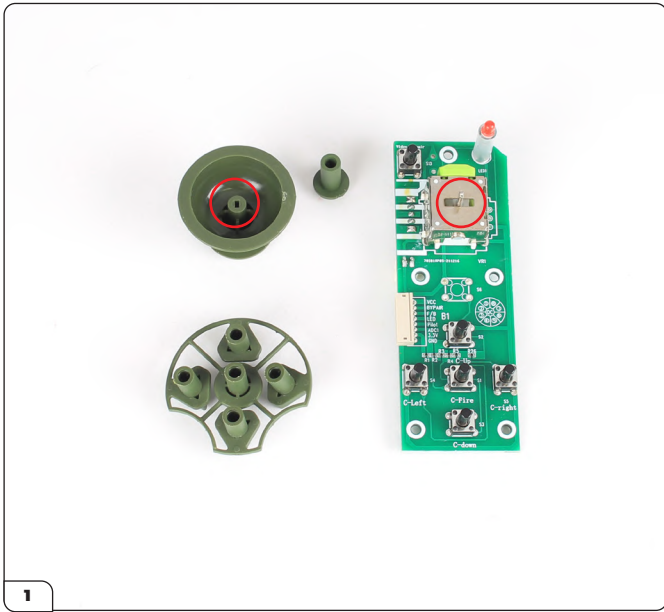

STAGE COMPLETE



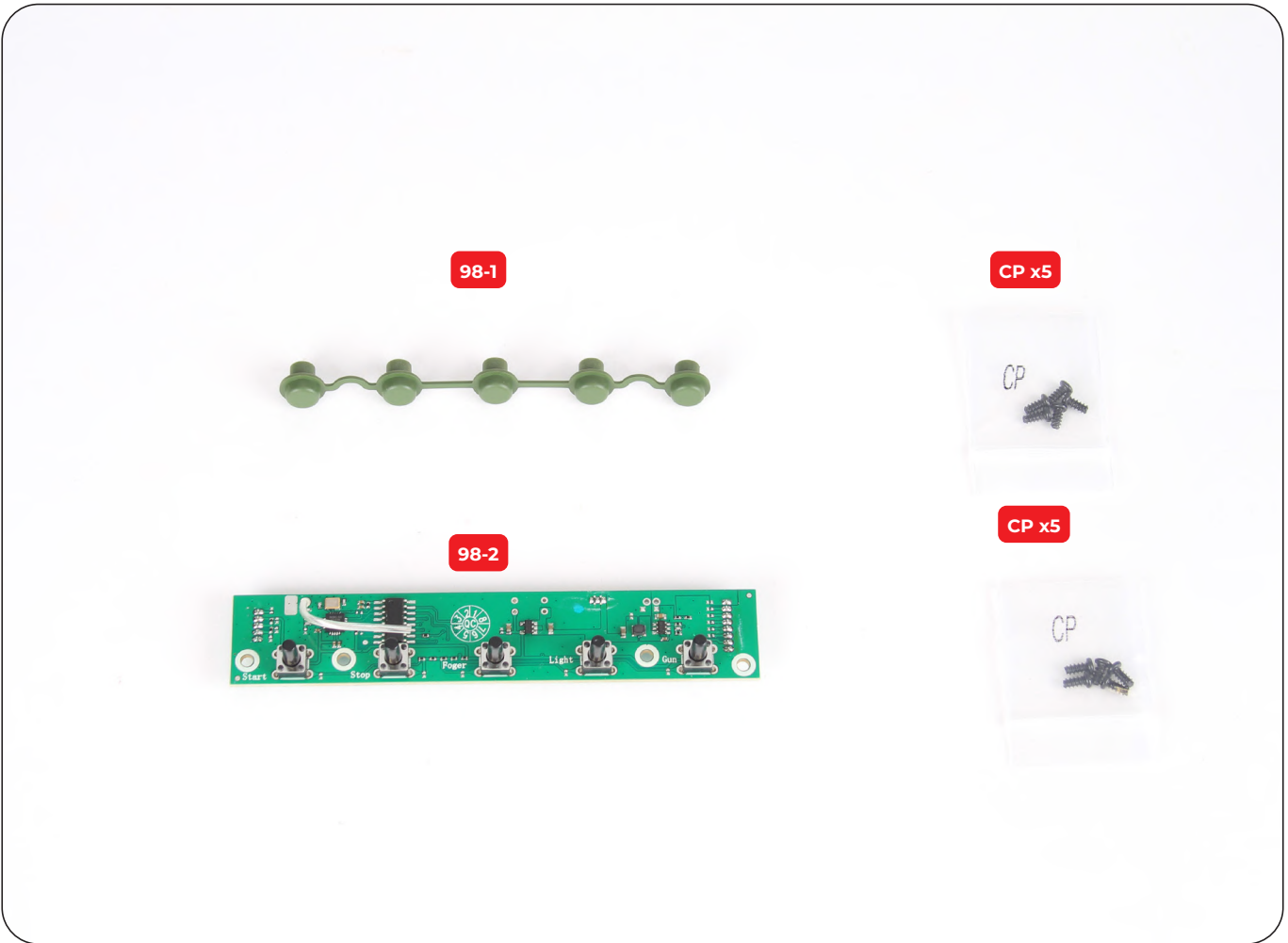

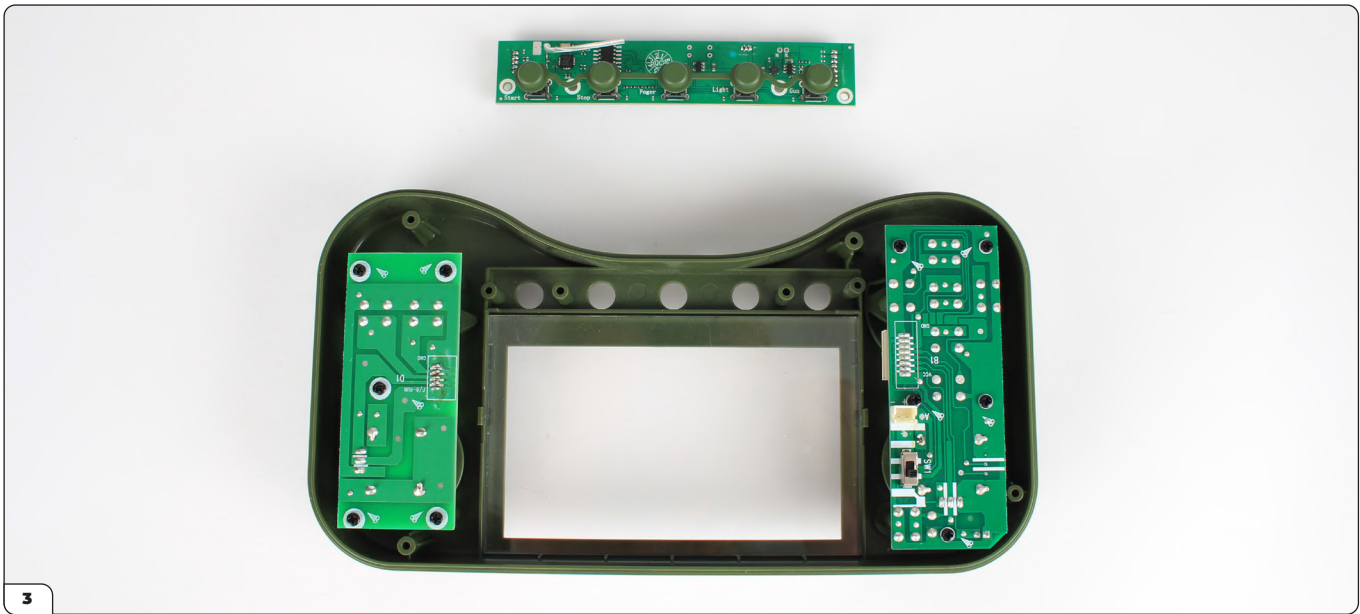
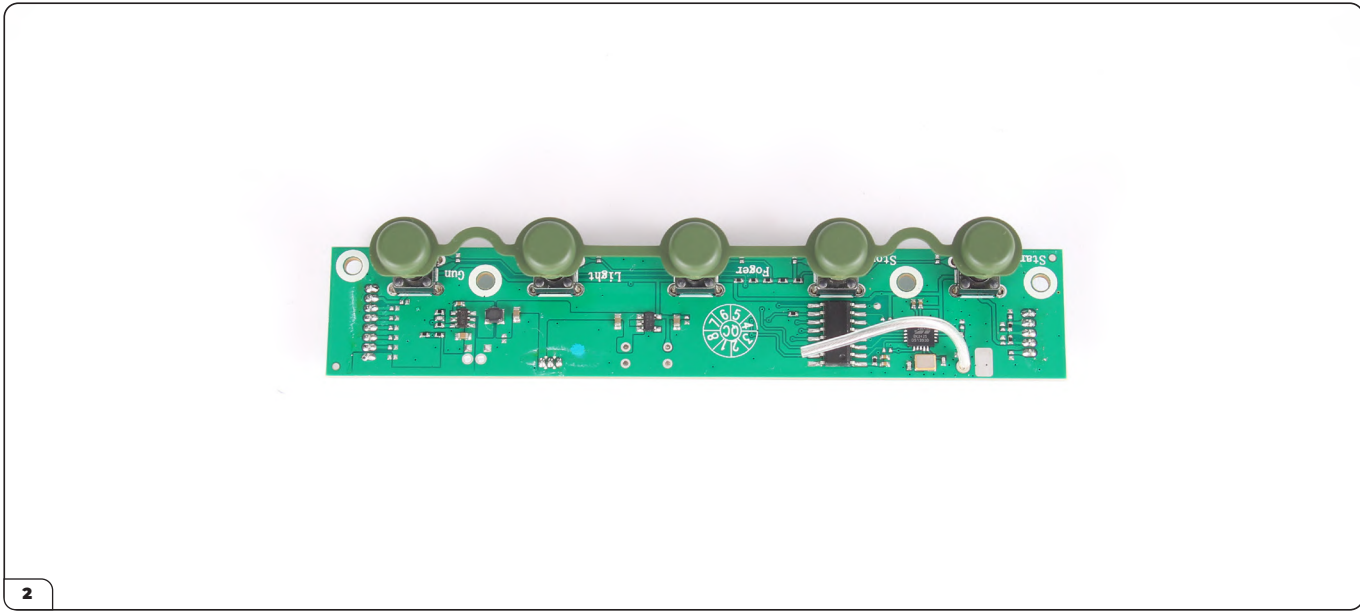
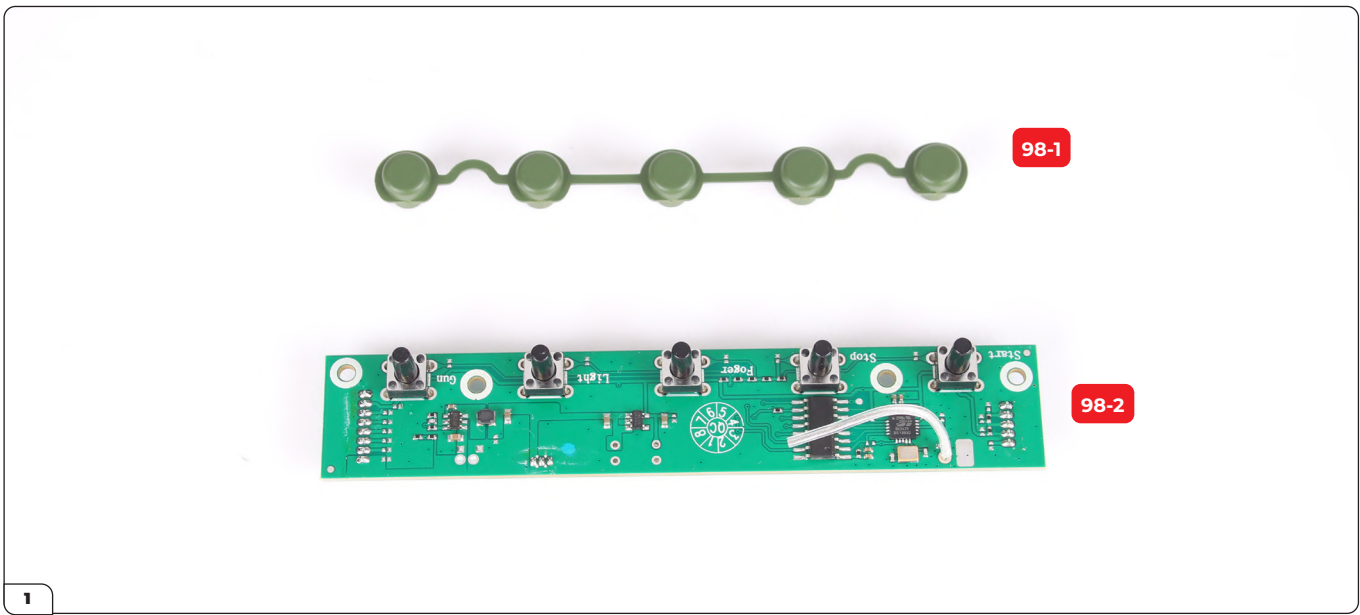

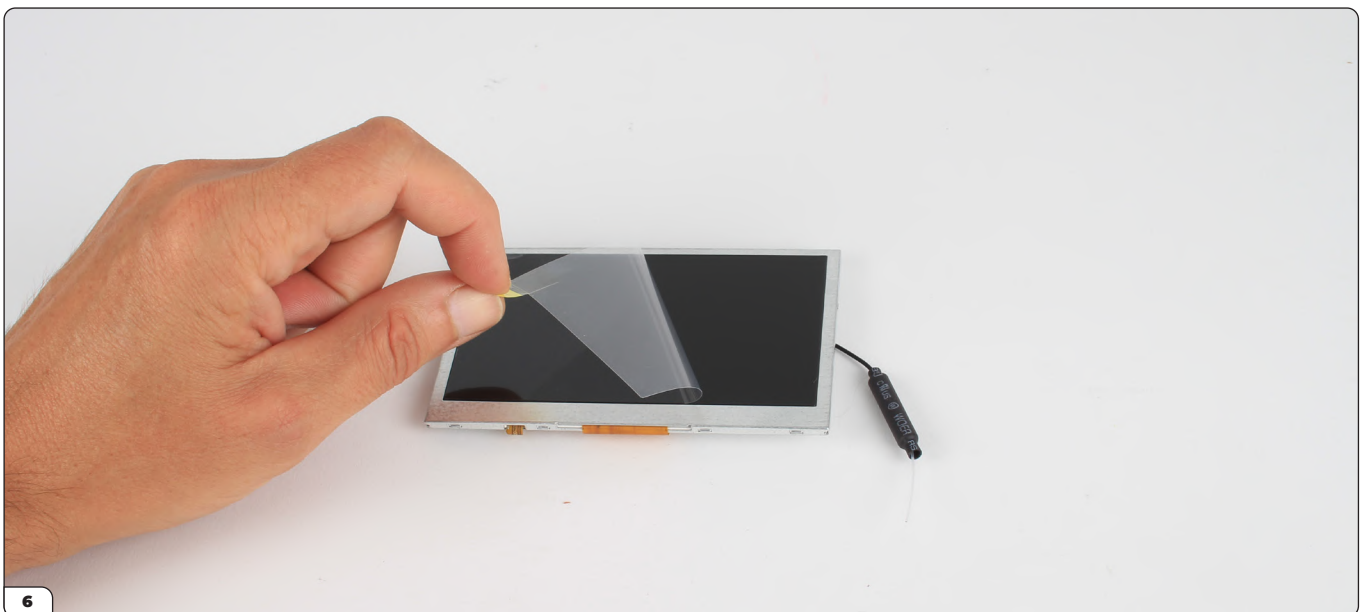
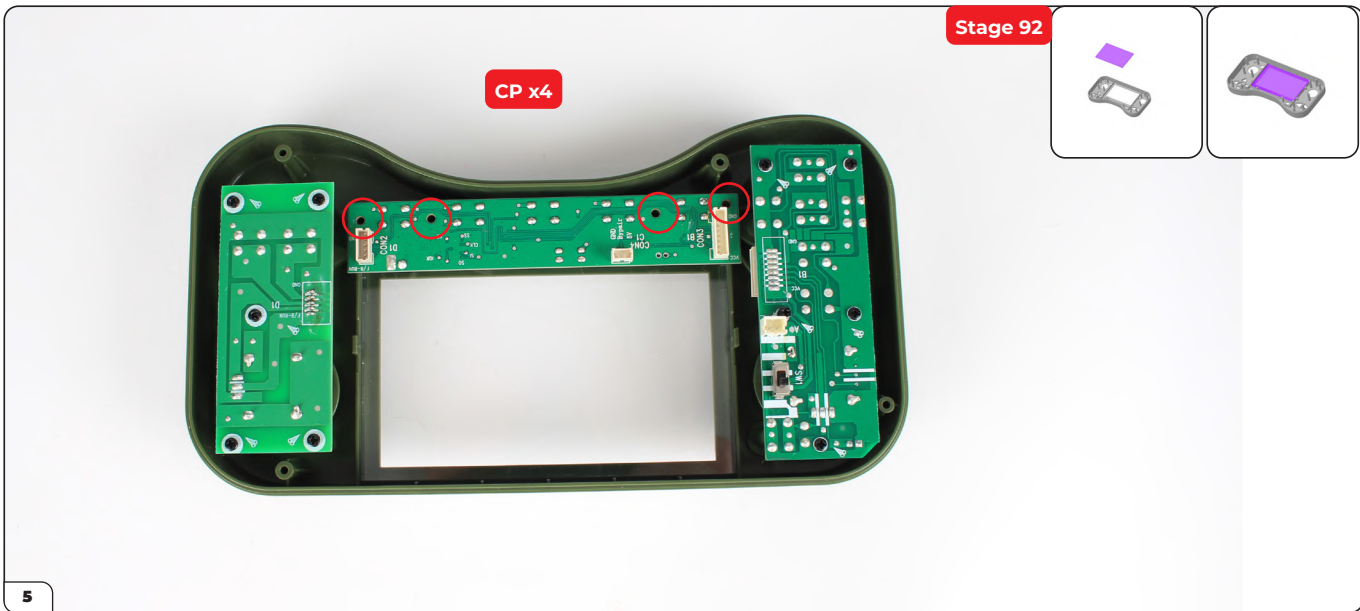
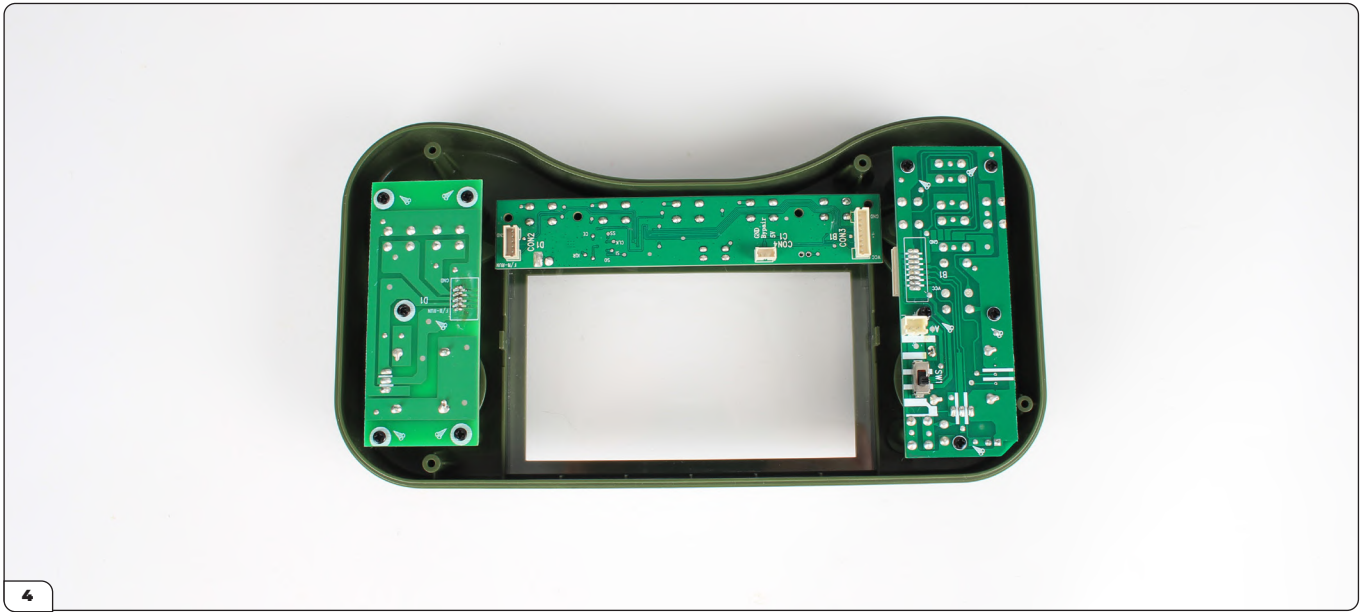

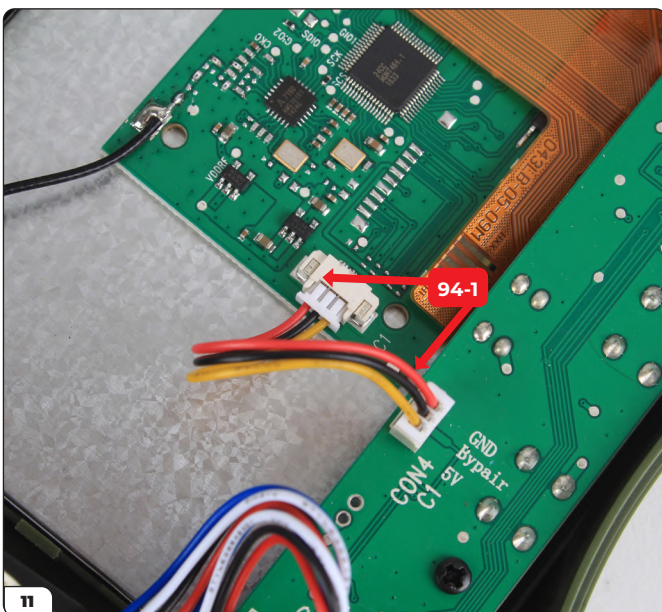
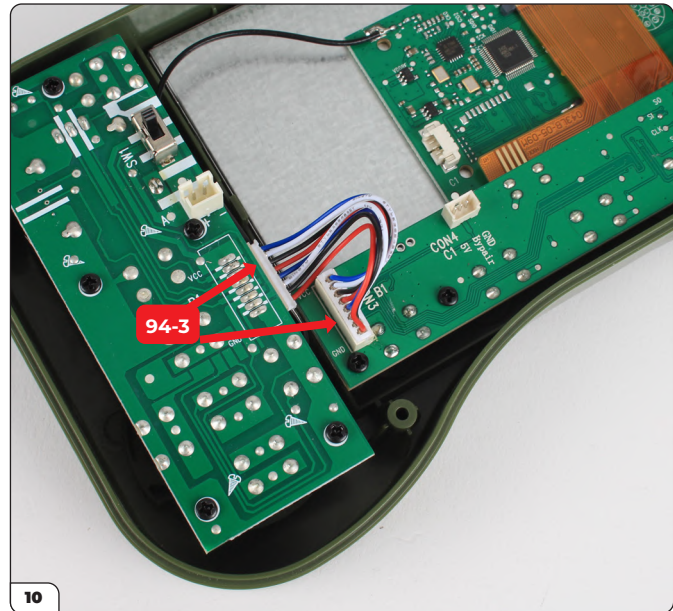
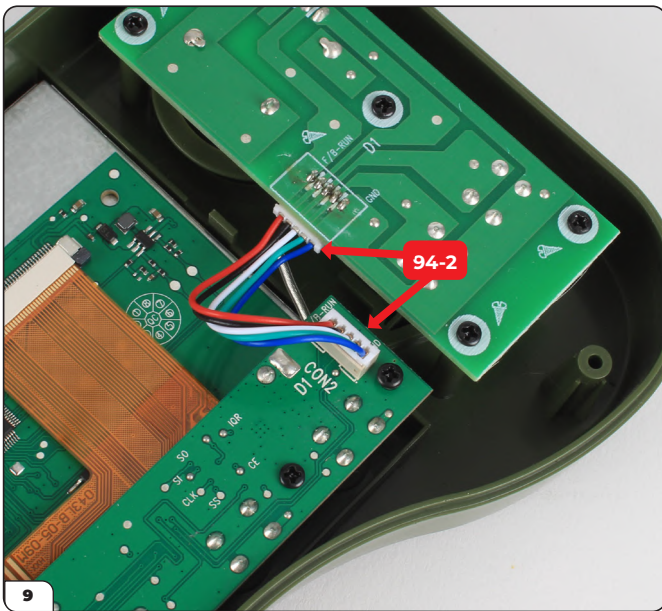
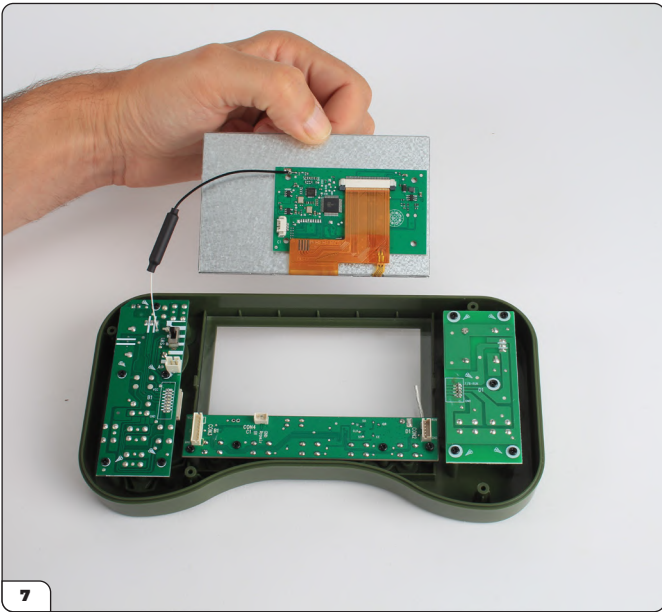

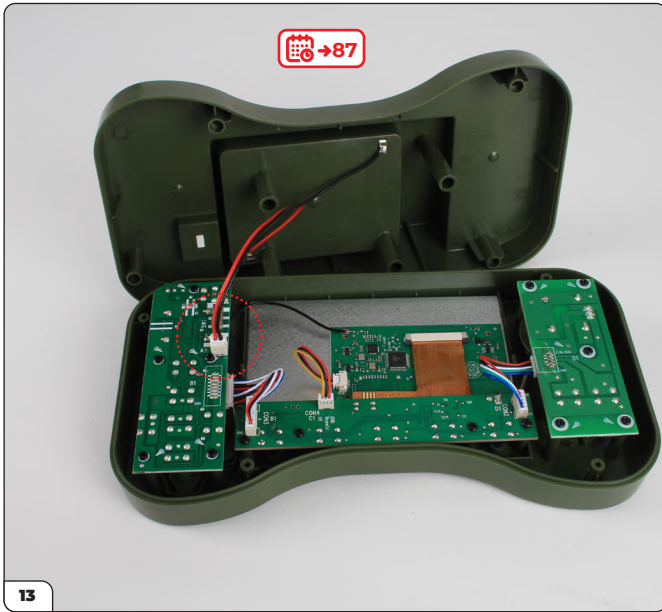

STAGE COMPLETE



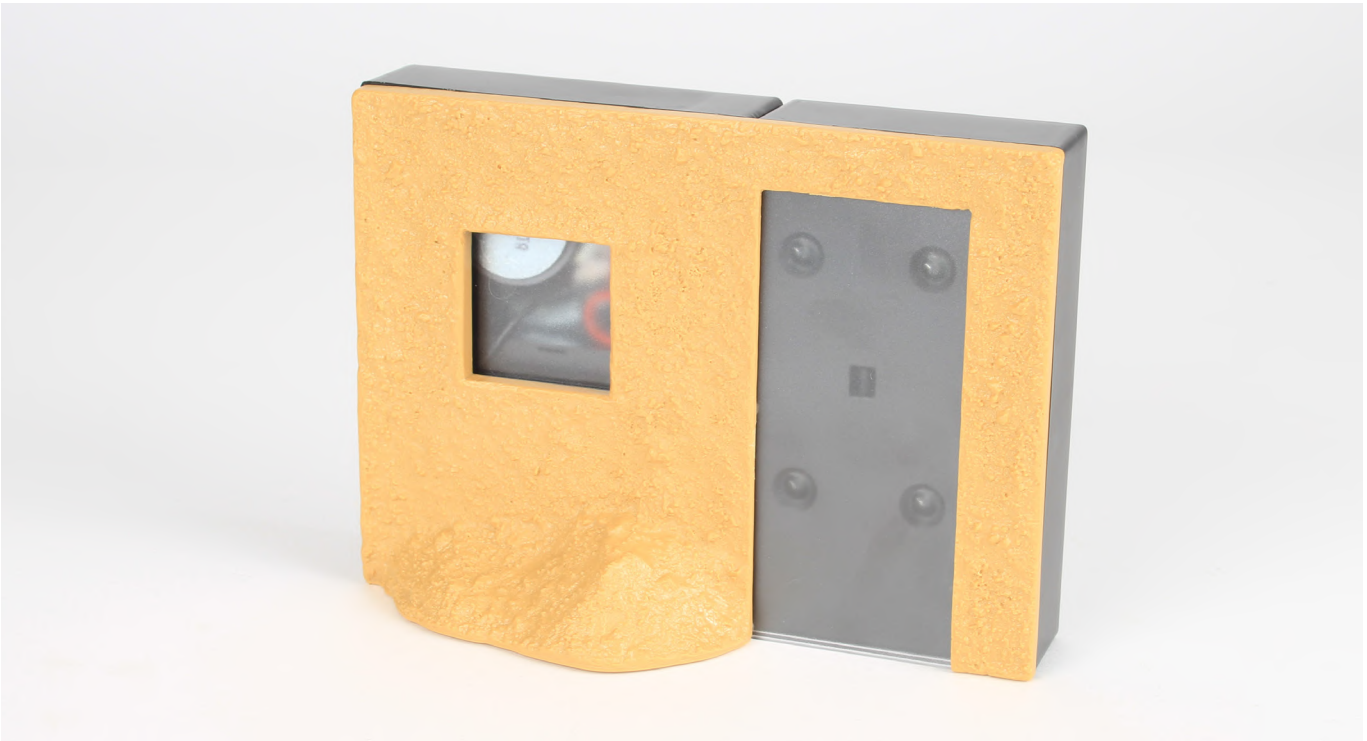

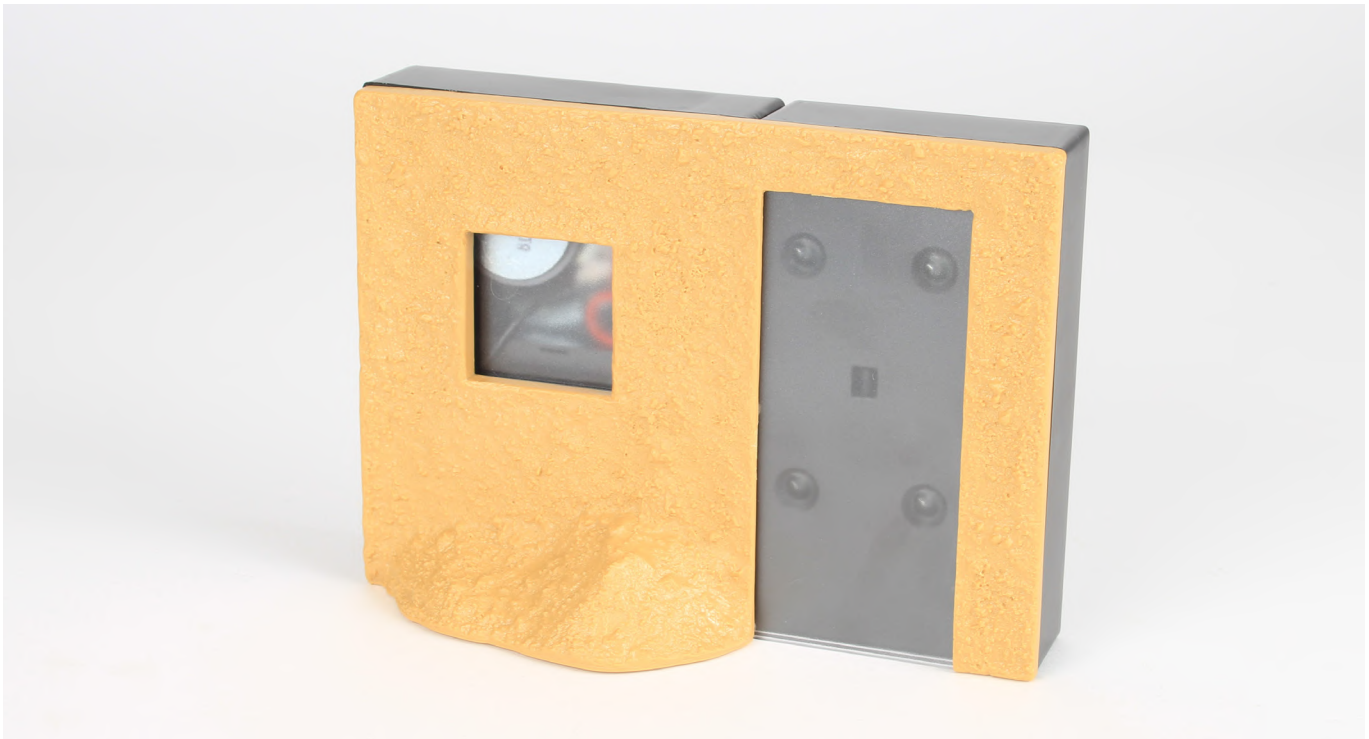

100

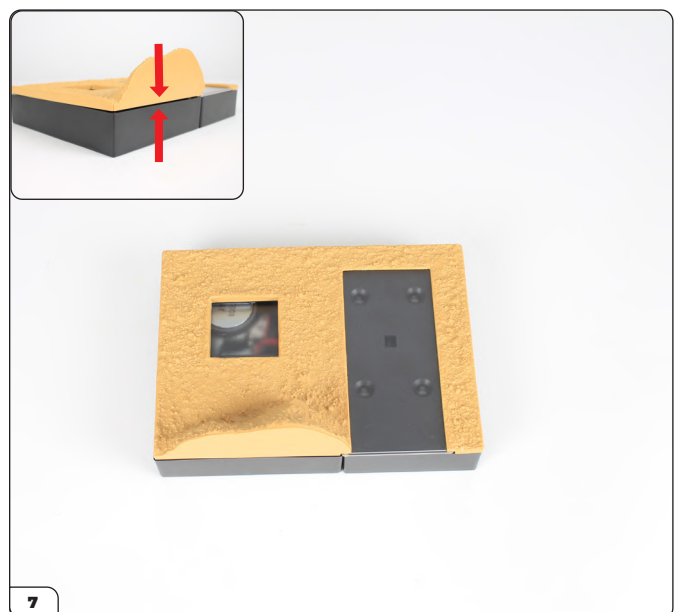
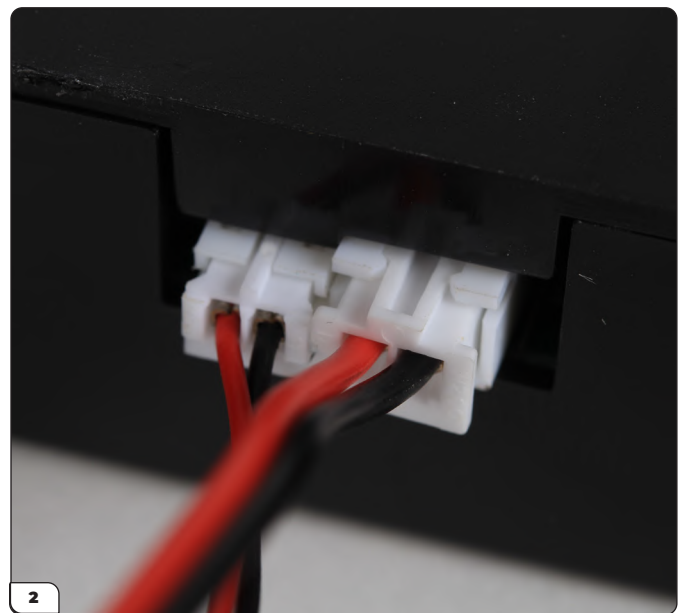
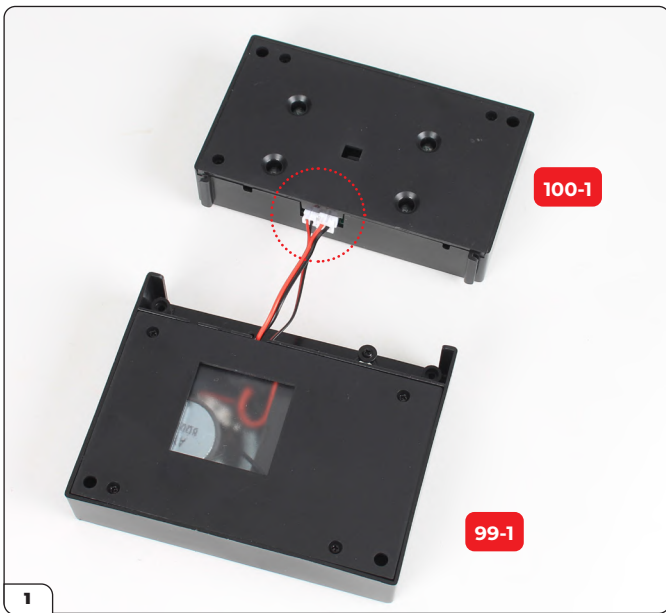

100





Check list for operation:

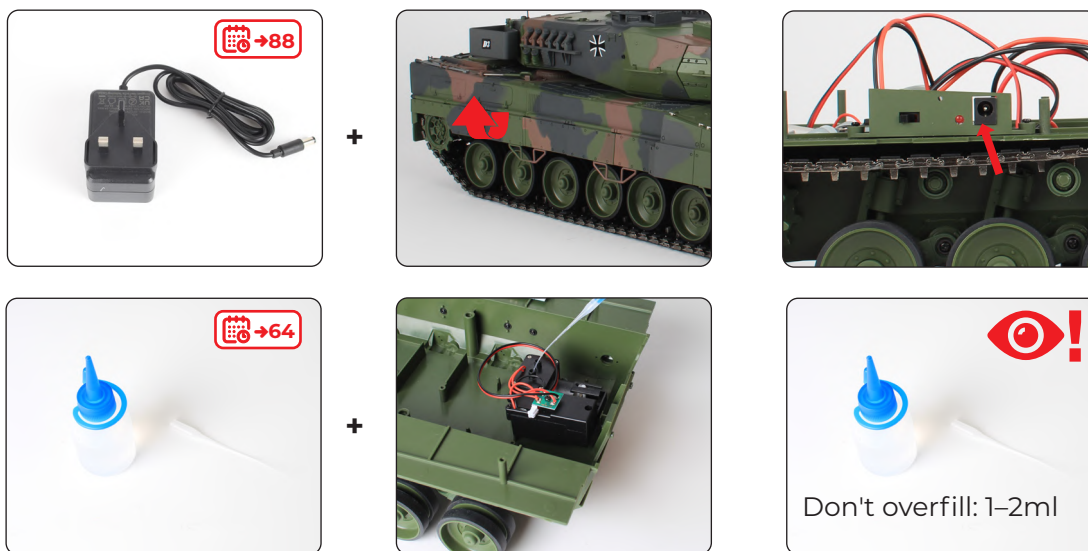

Stage Complete!

We hope you have enjoyed building your Leopard 2A6 Main Battle Tank.
 Don't forget, when you choose your next model the first pack is absolutely free!
 Go to agoramodels.com for more details.

Troubleshooting

TURRET MOVEMENT:

If the turret is not turning left and right, the turning gear may be screwed too tight.
Loosen each screw by 1 – 1.5 turns.

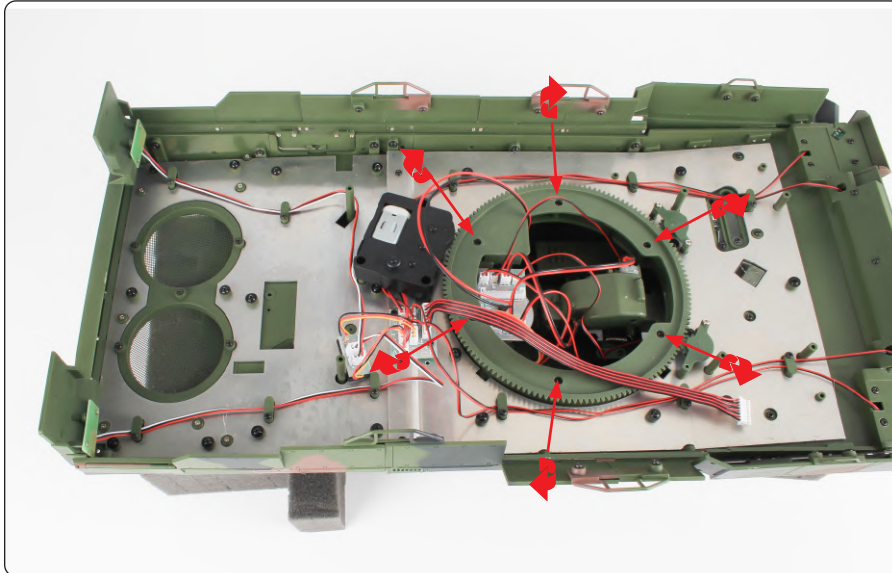

GUN MOVEMENT:

If the main gun is not moving up and down there may be some flash on the corners that needs smoothing.
Remove any excess flash using a file, fine sandpaper or craft knife to ensure free movement of the canon.

