



# E-TYPE



## Pack 12

### BUILD INSTRUCTIONS

**STAGE 91: ATTACHING THE DRIVER'S DOOR AND TRIM**

**STAGE 92: ATTACHING THE PASSENGER'S DOOR, THE ENGINE AND THE DASHBOARD**

**STAGE 93: FITTING THE FLOOR WITH THE ELECTRICAL CIRCUIT BOARD**

**STAGE 94: SECURING THE TARPAULIN**

**STAGE 95: INSTALLING THE PROP SHAFT AND LEFT REAR LIGHT**

**STAGE 96: CONNECTING THE WIRING, RIGHT REAR LIGHT, FUEL TANK AND BONNET**

**STAGE 97: ATTACHING THE FRONT BUMPER AND UNDERSIDE**

**STAGE 98: REAR END PANEL**

**STAGE 99: FITTING THE REAR END PANEL**

**STAGE 100: INSTALLING THE EXHAUST PIPES**

## Advice from the experts

---

Spare screws are included with each part. Occasionally, you may be instructed to keep spare or unused screws for a later stage. Keep these spares in a safe place and label them correctly.

Please make sure you don't mix up the screws. They look quite similar, but the threads do vary slightly. Using the wrong screws may damage the parts.

When securing parts together using multiple screws, fit each screw loosely to ensure all the parts are correctly aligned before gently tightening them firmly, but not overtight, in the order in which you placed them.

The screwdriver can be magnetized by stroking it with a magnet (fridge magnet, etc.) enabling it to hold the screws and make assembly easier.

If a screw is tight going into a metal part, do not force it as you may shear the head off. Remove it and put a tiny smear of Vaseline, soap or light oil on the thread. That will lubricate it and make it easier to drive home.

During the course of this build, you will receive many pieces that you will assemble immediately – following the instructions in the corresponding stage – and other pieces that you should store safely to one side, for use in future assembly stages.

Left and Right! When building your Jaguar, the left or right hand side refers to each side as you are sitting in the car.



**WARNING:** Some parts are assembled using magnets. These magnets can cause serious injury if they are swallowed. Keep away from children. If you suspect a magnet has been swallowed, seek medical help straight away.

## Stage 91: Attaching the Driver's Door and Trim

In this first stage, you'll fit the trim for the right door frame to the body before attaching the driver's side door onto your model.



### STAGE 91 PARTS LIST

Name
Right body door frame trim
Screws type AM08 x3

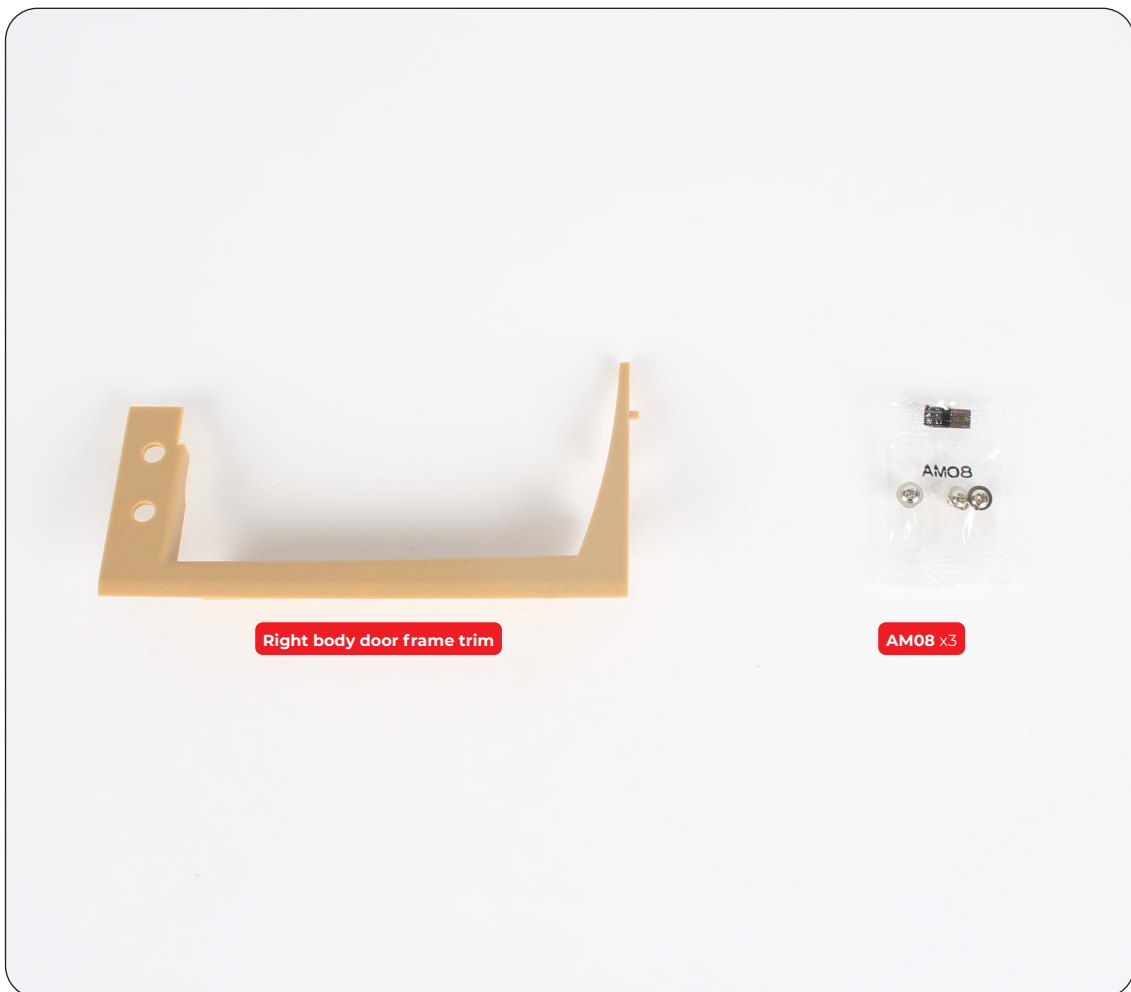

## Stage 91: Attaching the Driver's Door and Trim

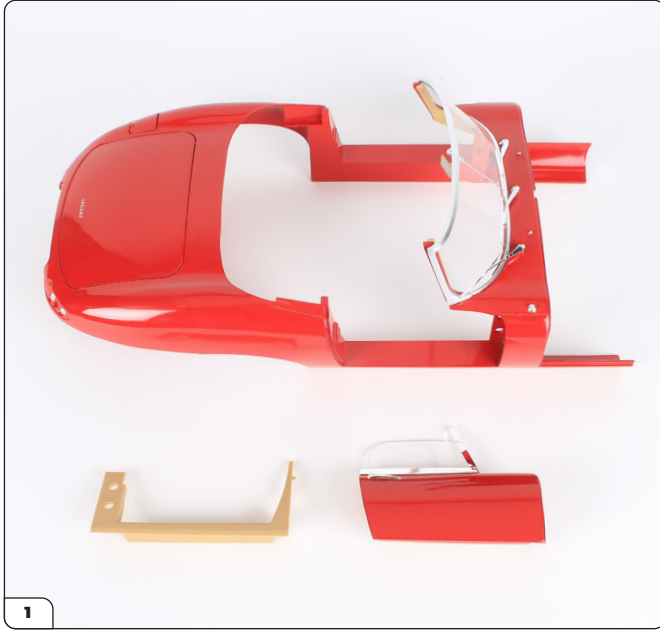

Take the body assembly from Stage 89 and the driver's door from Stage 1.

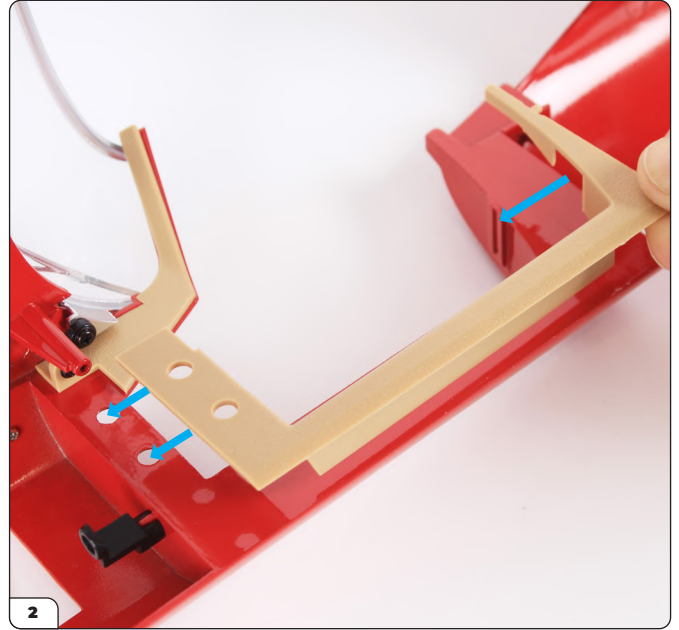

Lay the body assembly on a protective surface, then align the right body door frame trim with it as shown, noting the two screw holes and rectangular notch in the trim.

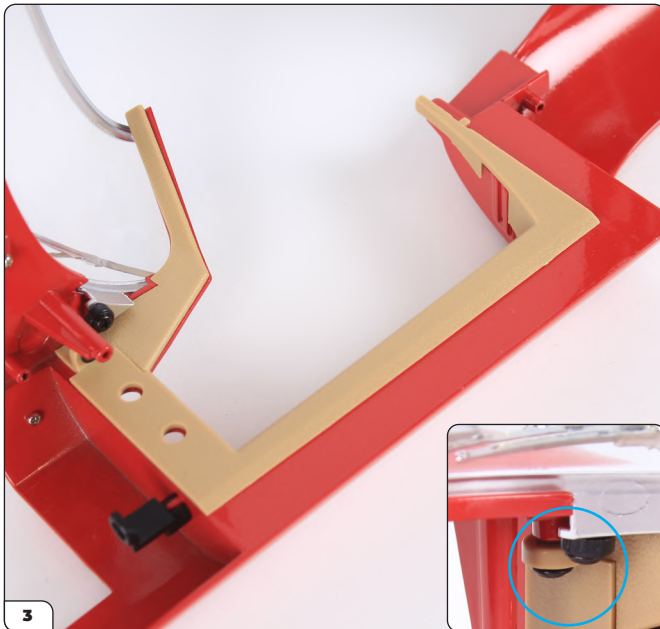

Fit the two screw holes and rectangular notch over the corresponding parts of the body and press firmly into place. Note that the screws (circled, inset) can get in the way, so take care when fitting the trim.

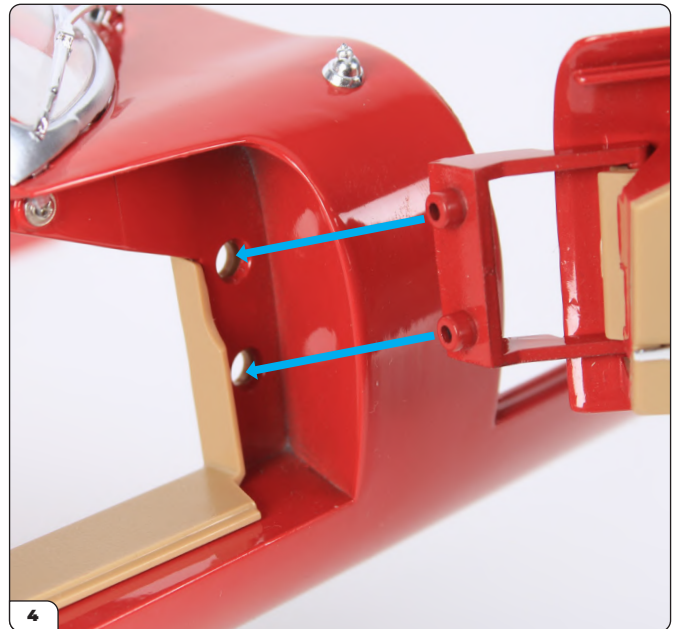

Next take the driver's door and locate the screw hole lugs on the hinge. Align the lugs with the corresponding holes on the outside of the body as shown.

## Stage 91: Attaching the Driver's Door and Trim

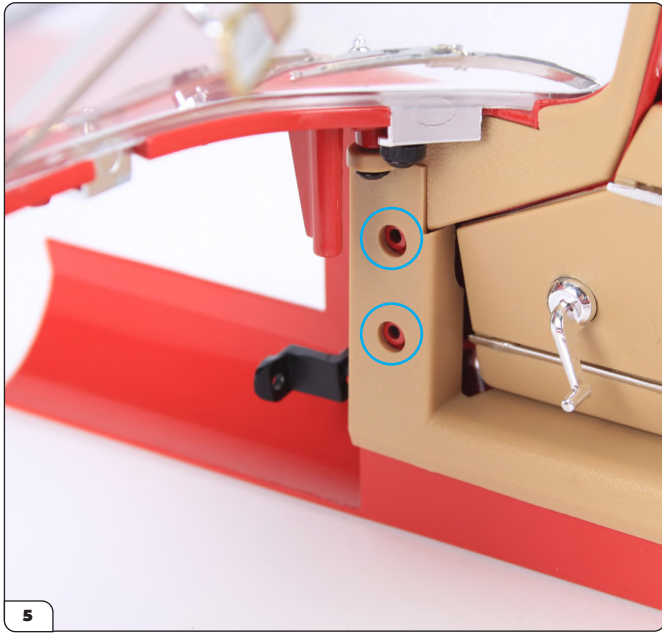

Press the door firmly into place so that the lugs are visible through the trim from inside the car (circled).

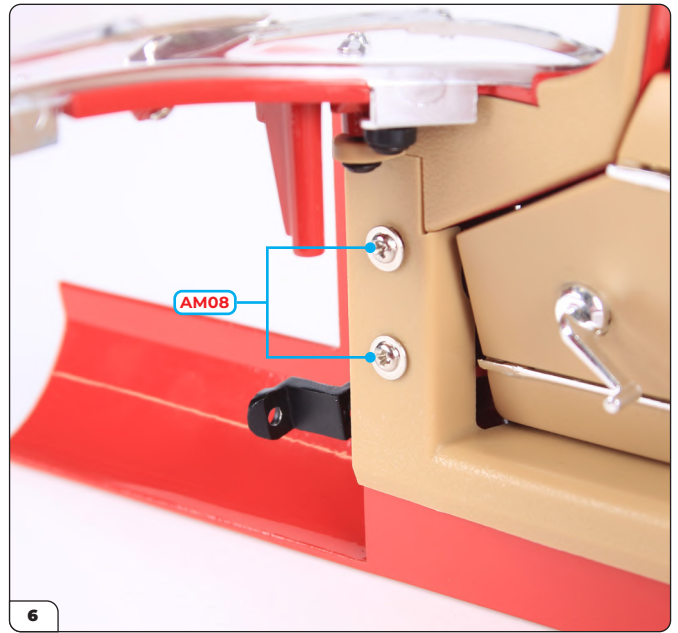

Secure both the door and the trim in place with 2x AM08 screws. Make sure these screws are tight – try using a drop of oil over the threads if needed.

**STAGE COMPLETE**

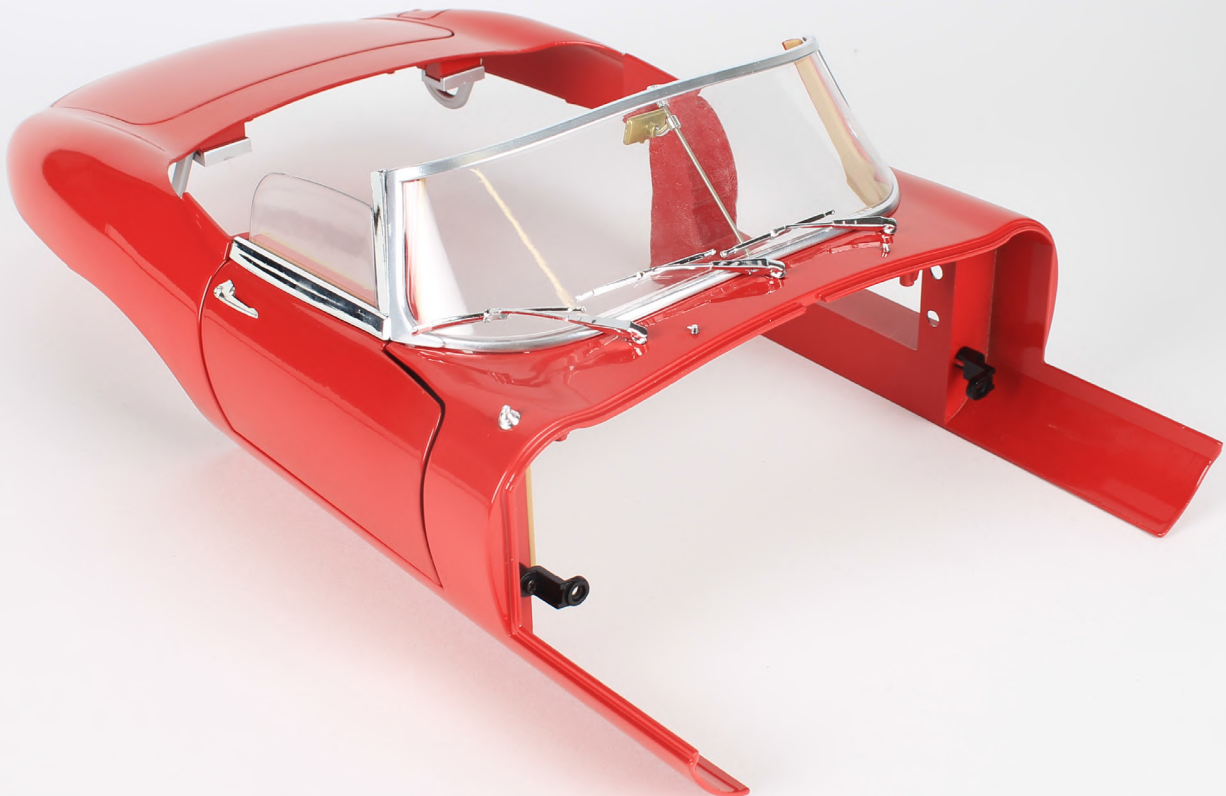

# Stage 92: Attaching the Passenger's Door, the Engine and the Dashboard

Now it's time to fit the passenger's door. With both doors fitted, you'll then begin to bring everything together by installing the engine subframe and the dashboard.



## STAGE 92 PARTS LIST

Name
Left body door frame trim
Bush x3
Screws type AM01 x 11
Screws type AM05 x3
Screws type AM08 x3

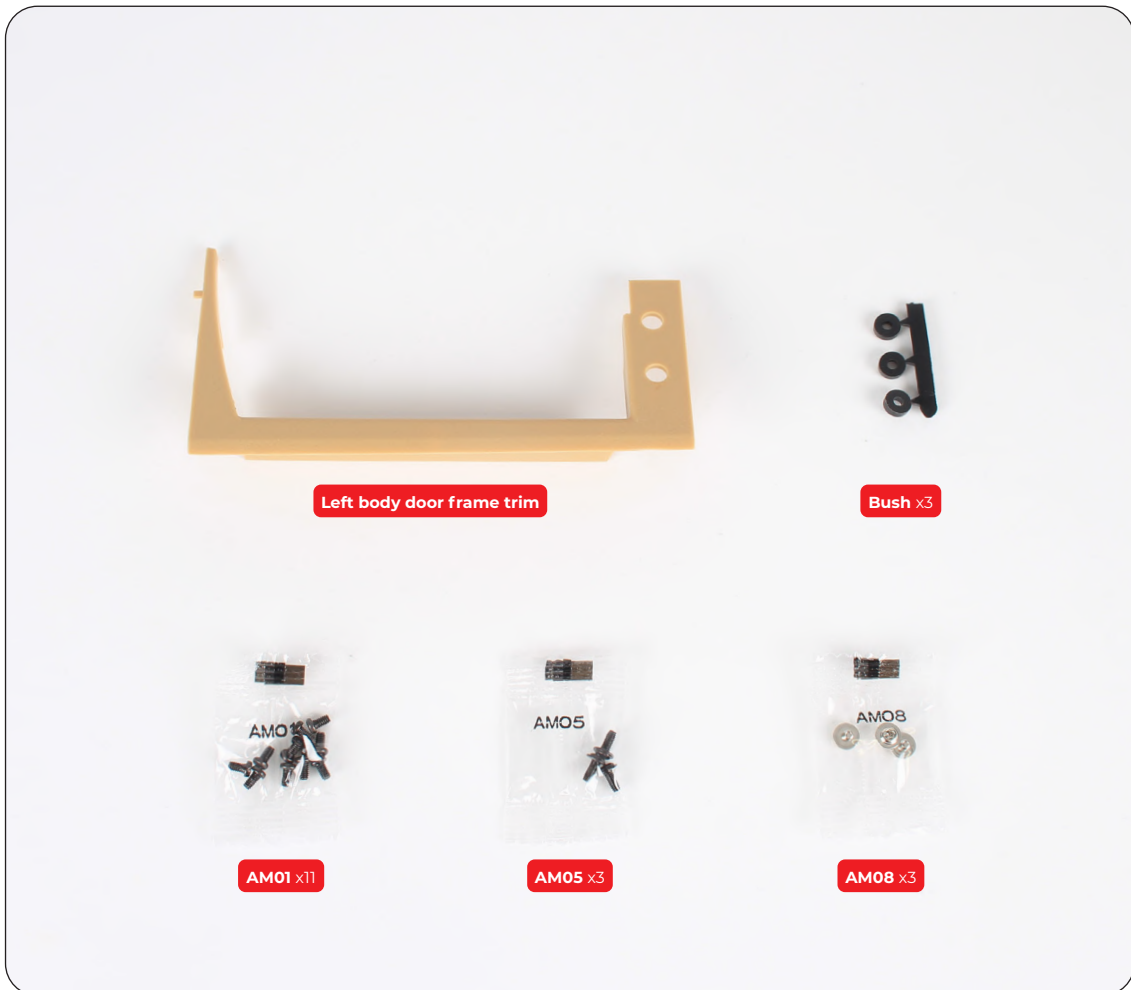

# Stage 92: Attaching the Passenger's Door, the Engine and the Dashboard



For this stage you'll need the body assembly and the engine assembly. You'll also need the left passenger door from Stage 13 and the dashboard from Stage 64. Place the body on a soft cloth or similar to protect the paintwork during assembly.

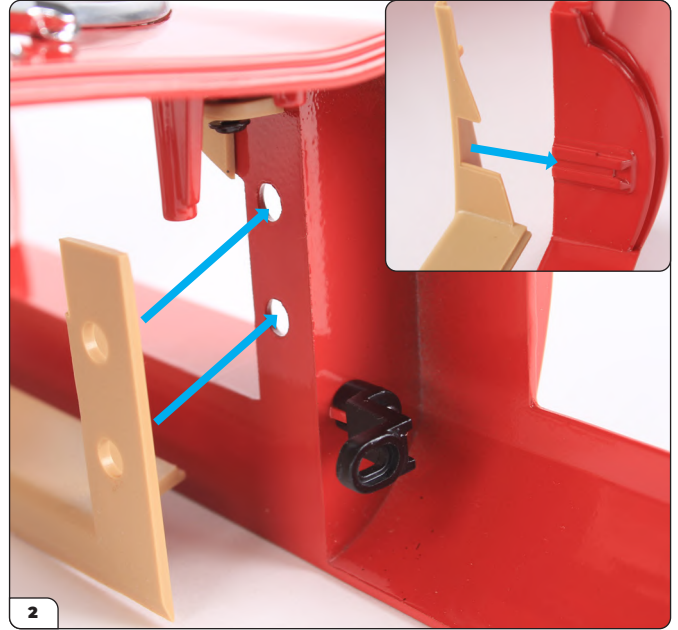

Align the screw holes and notch as you did with the door frame trim from the previous stage.

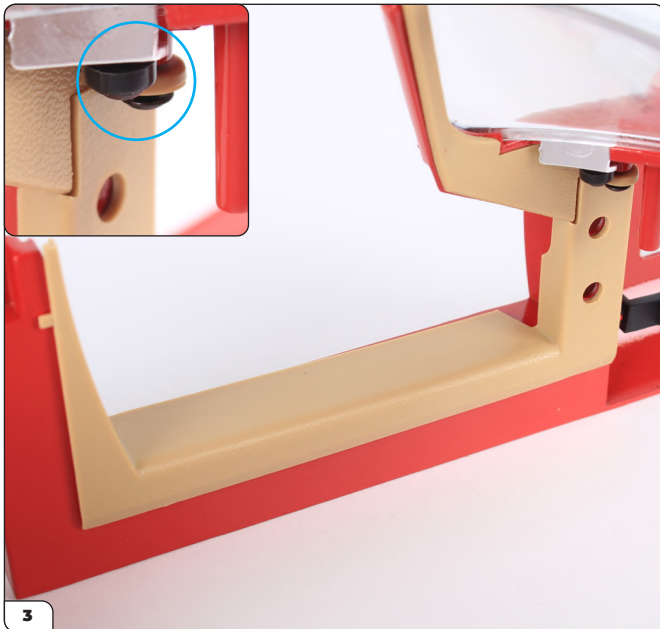

Fit the two screw holes and rectangular notch over the corresponding parts of the body and press firmly into place. Note that the screws (circled, inset) can get in the way, so take care when fitting the trim.

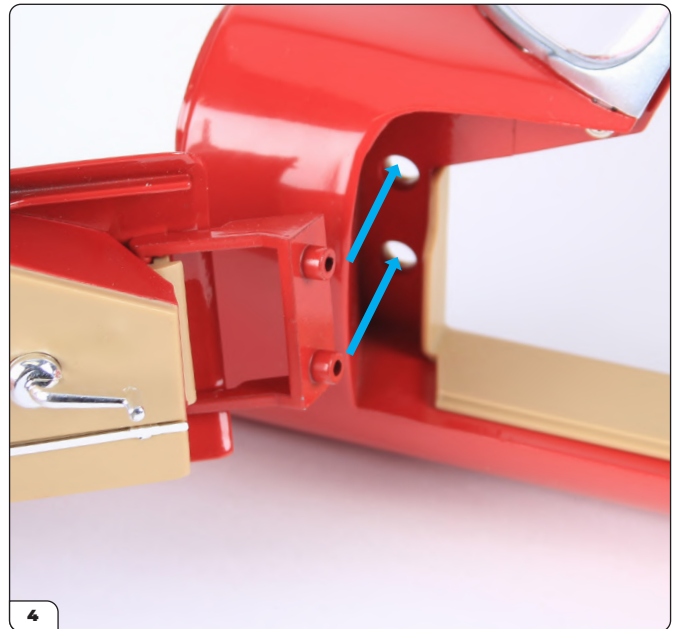

Next take the passenger's door and locate the screw hole lugs on the hinge. Align the lugs with the corresponding holes on the outside of the body as shown.

## Stage 92: Attaching the Passenger's Door, the Engine and the Dashboard

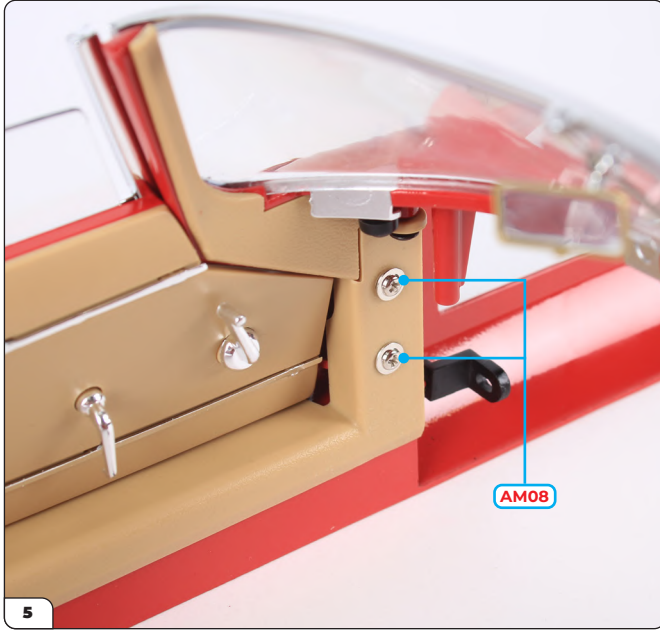

5 Secure both the door and the trim in place with 2x AM08 screws. Make sure these screws are tight – try using a drop of oil over the threads if needed.

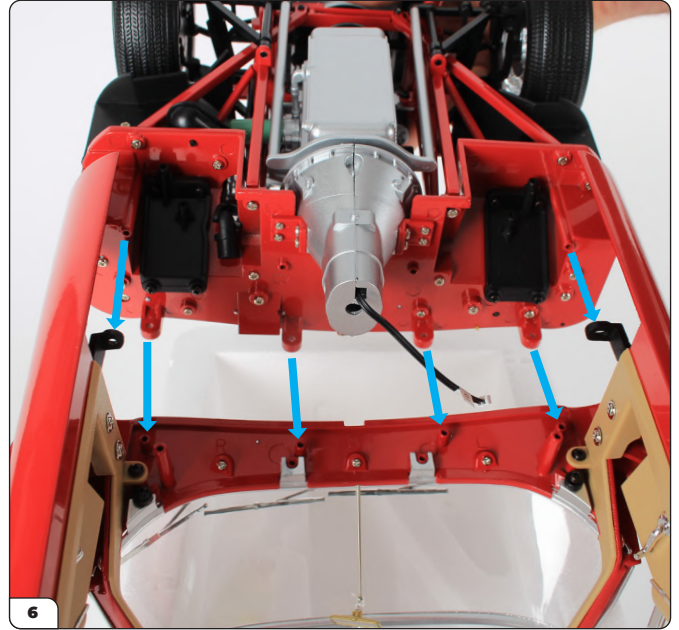

6 Turn the car body upside down and take the engine assembly. Align the engine in place as shown.

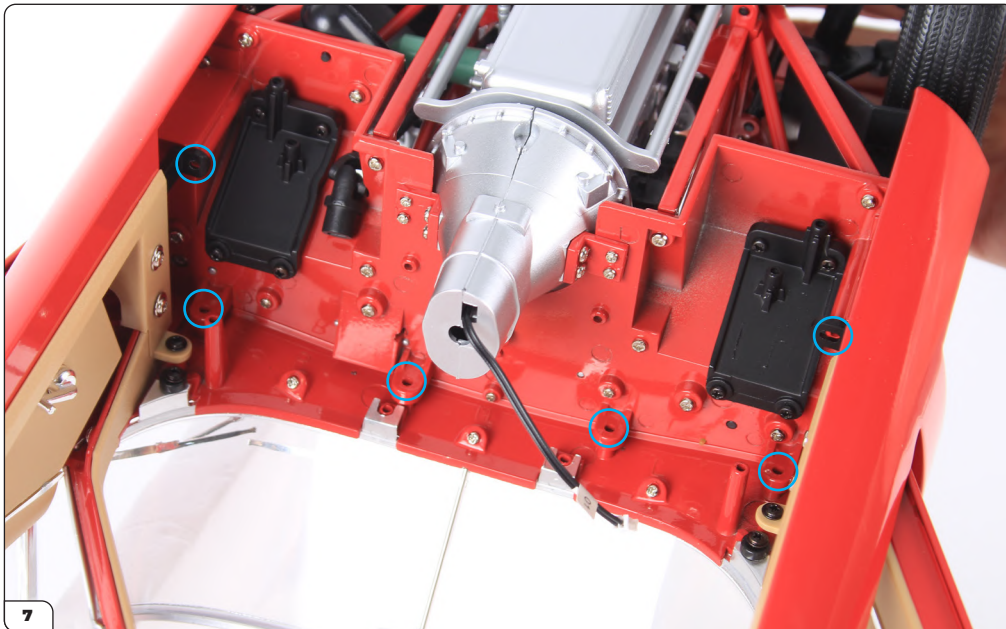

7 Place the engine assembly onto the body so that all the corresponding screw holes fit together (circled).



## Stage 92: Attaching the Passenger's Door, the Engine and the Dashboard

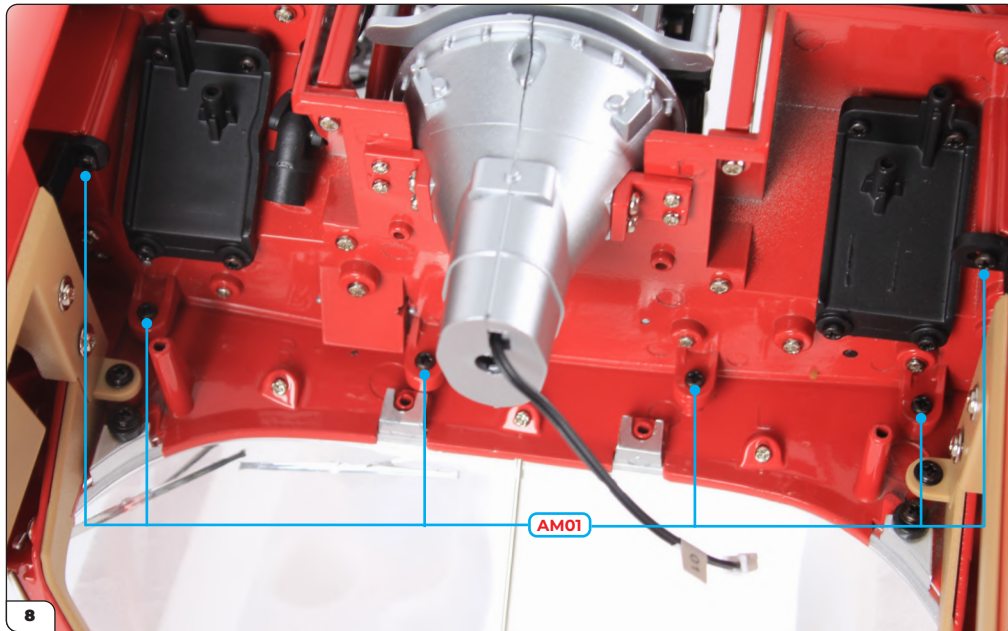

Attach the engine to the body using 6x AM01 screws.

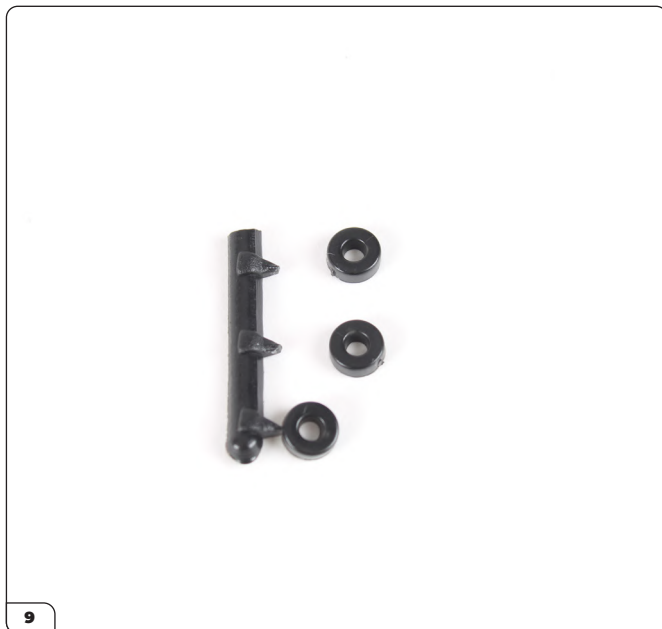

Next detach two of the bushes from their sprue using sprue cutters.



Push an AM05 screw through each of the two bushes. The screw should protrude from the flat face of the bush as shown.

## Stage 92: Attaching the Passenger's Door, the Engine and the Dashboard

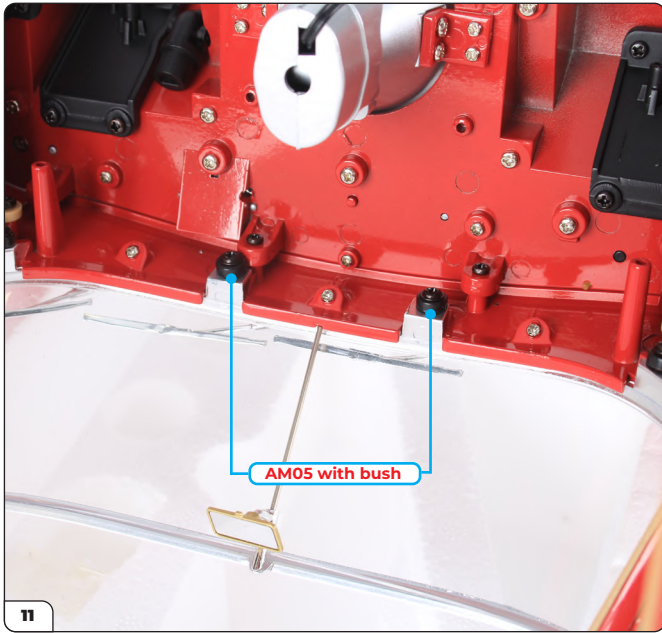

11 Drive the AM05 screws with the bushes into the two central holes of the windshield frame.

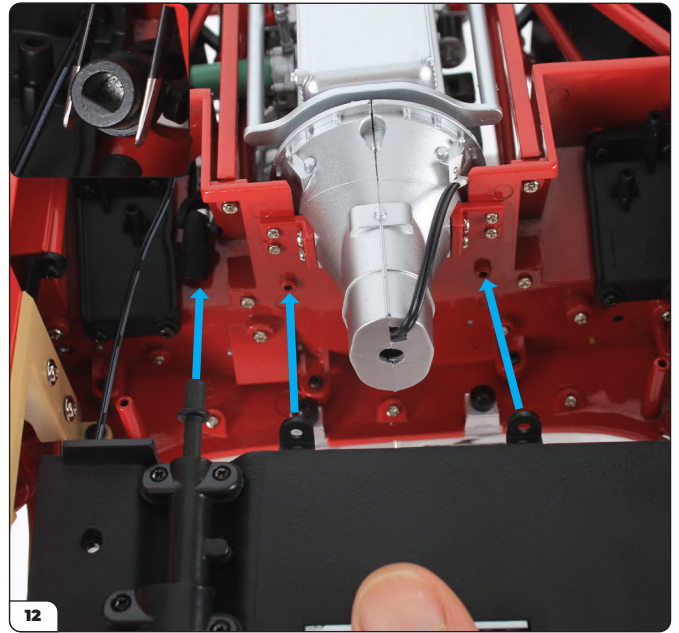

12 Next, take the dashboard and locate the two holes for securing it to the body. The column from the steering wheel needs to align with the column that controls the front wheels – ensure the D-shaped plug and hole are oriented the same way before fitting (inset).

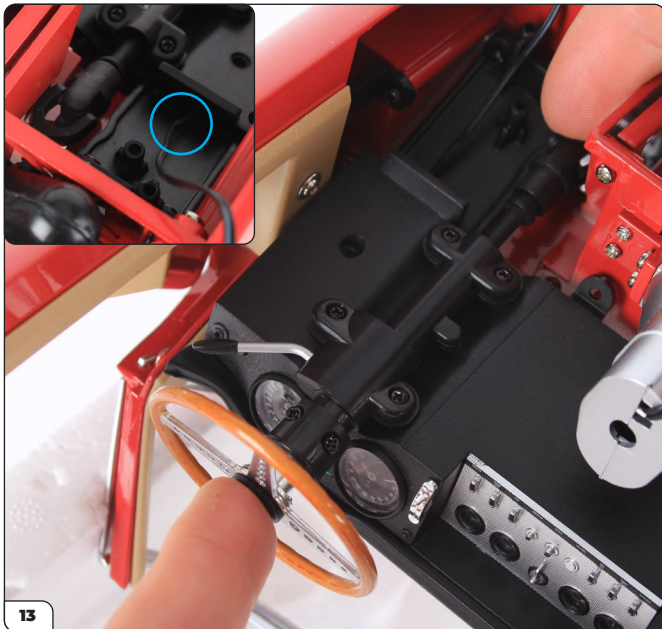

13 As you fit the dashboard, push the steering wheel and steering column shaft together as shown. You may need to adjust the alignment as you push to connect the column and shaft completely. Make sure the wire from the dashboard leads through the opening (inset, circled).

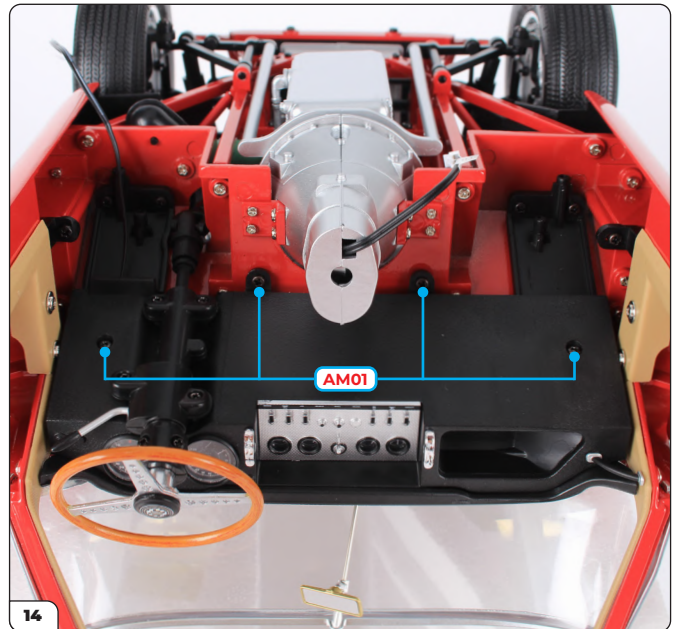

14 With the dashboard fitted in place, secure it with 4x AM01 screws.

## Stage 92: Attaching the Passenger's Door, the Engine and the Dashboard

STAGE COMPLETE



# Stage 93: Fitting the Floor with the Electrical Circuit Board

Next you'll work on the electrics by installing the main circuit board that controls all the LEDs and switches for your model, followed by fitting the floor into the car.

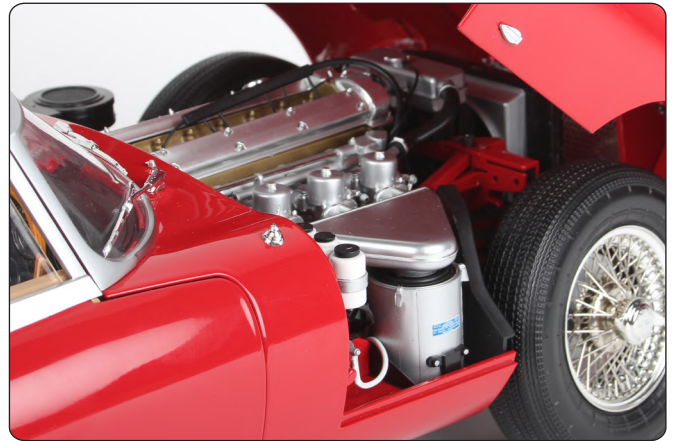

## STAGE 93 PARTS LIST

Name
Electrical wiring x7
Circuit board
Screws type AG02 x3
Screws type AM15 x11

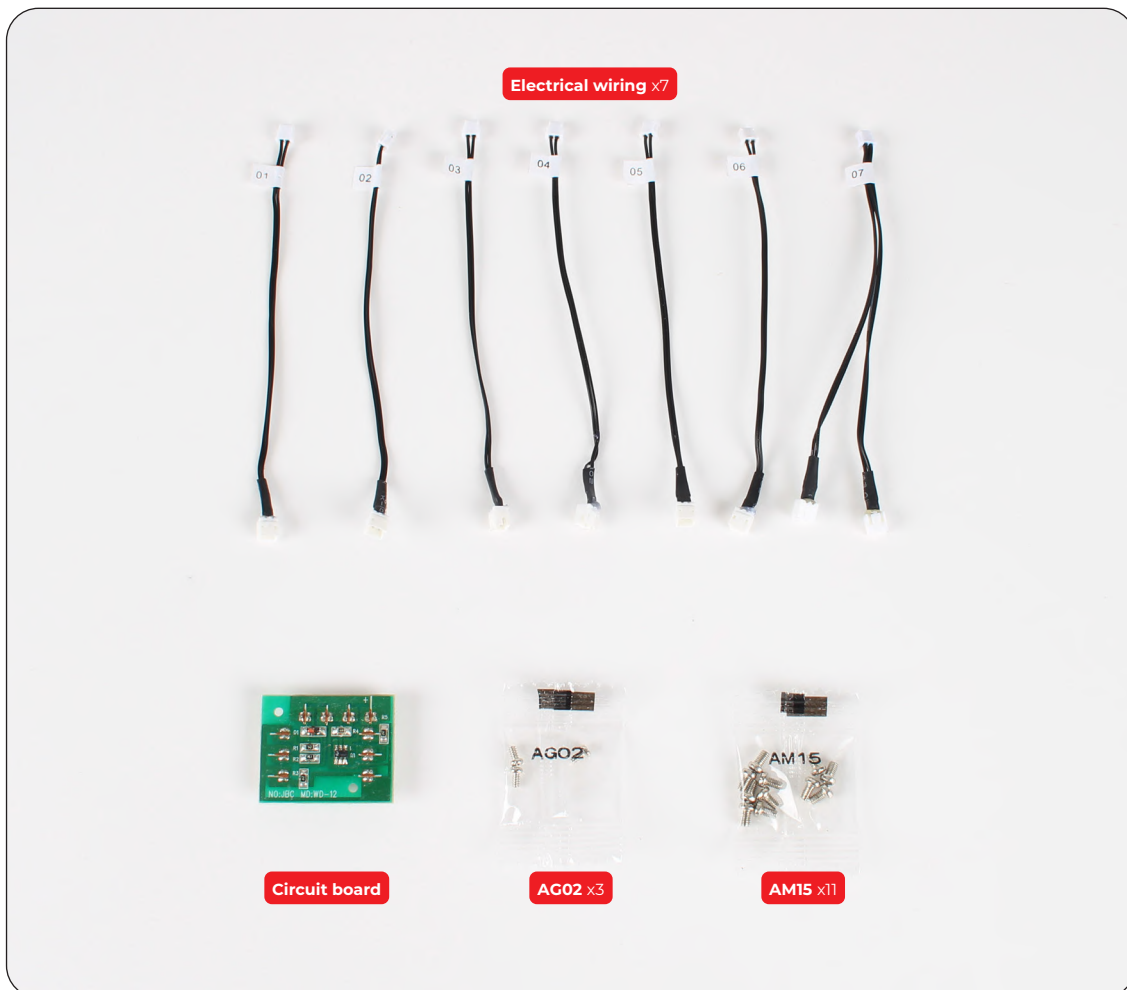

# Stage 93: Fitting the Floor with the Electrical Circuit Board



You'll need the body assembly from the previous stage along with the floor assembly from Stage 90.

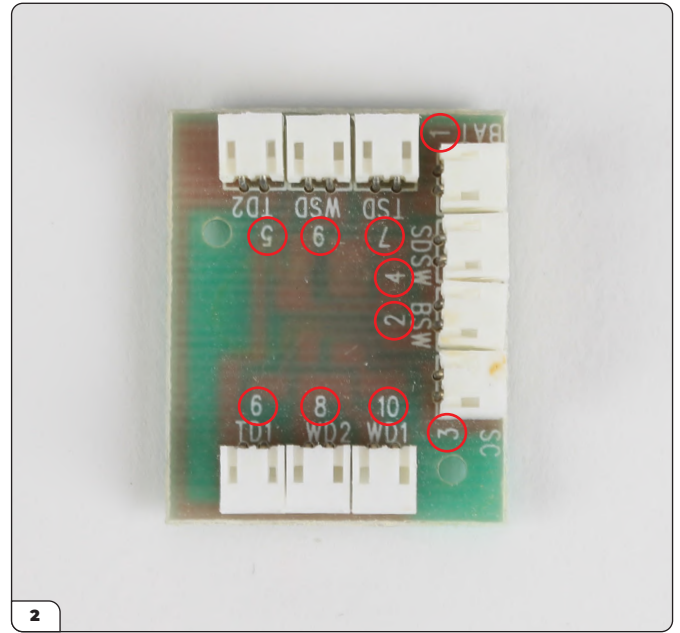

Make sure to handle the circuit board carefully as you install it, holding by the edges when necessary.

Note that the sockets on the board are numbered from 1 to 10 (circled).

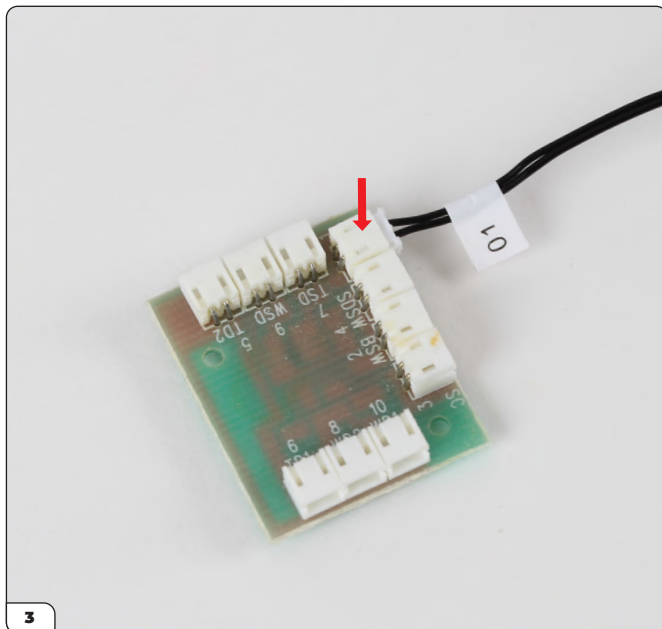

Place the circuit board on your work surface as shown, then take the electrical wire labelled '01' and plug it into the socket marked '1'.

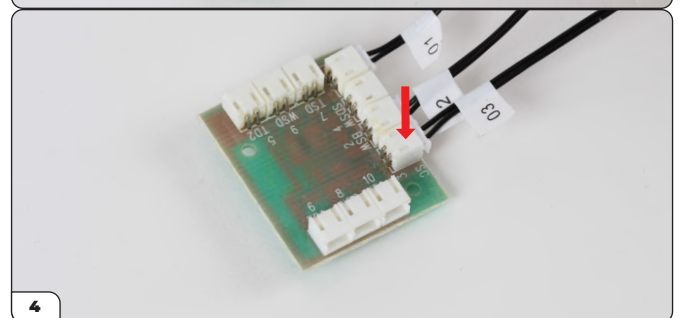
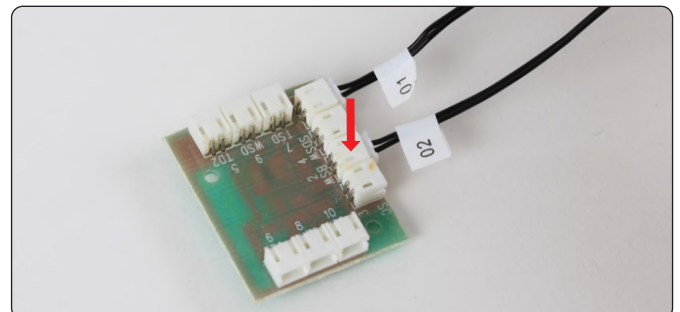

Plug wire '02' into socket '2', and wire '03' into socket '3' as shown.

# Stage 93: Fitting the Floor with the Electrical Circuit Board

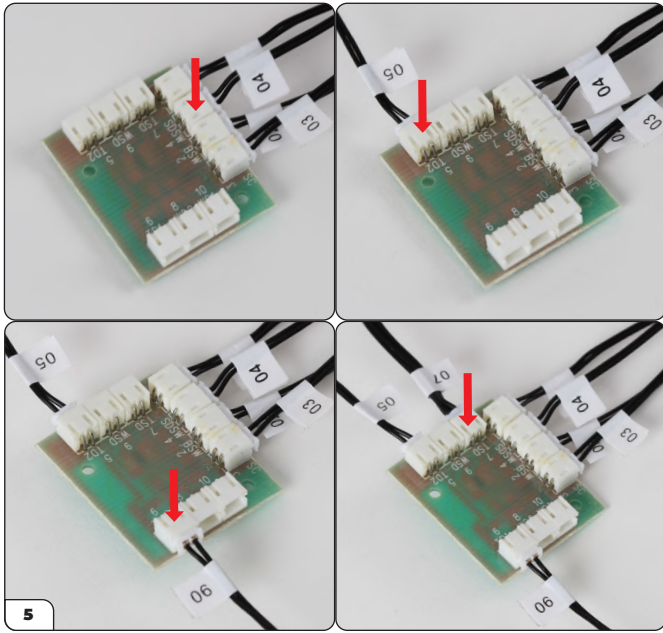

Plug wires '04', '05', '06', and '07' into the respective sockets as shown.

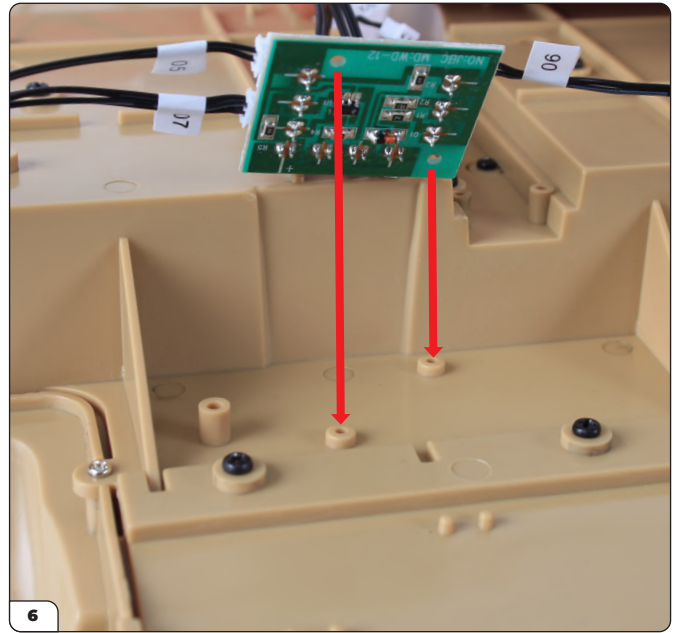

Locate the two screw holes for the circuit board on the underside of the floor (behind the driver's seat). Align the circuit board as shown.

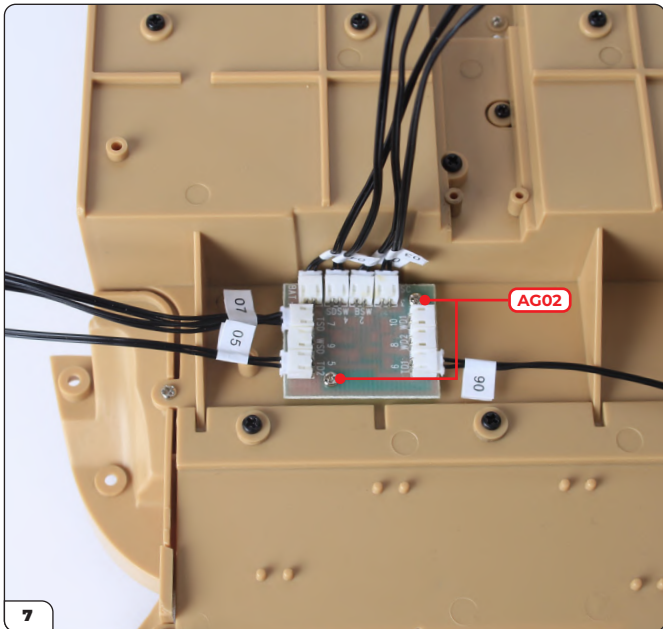

Carefully bend the wires '01', '02', '03' and '04' up against the floor assembly as you fit the board in place. Secure with 2x AG02 screws.

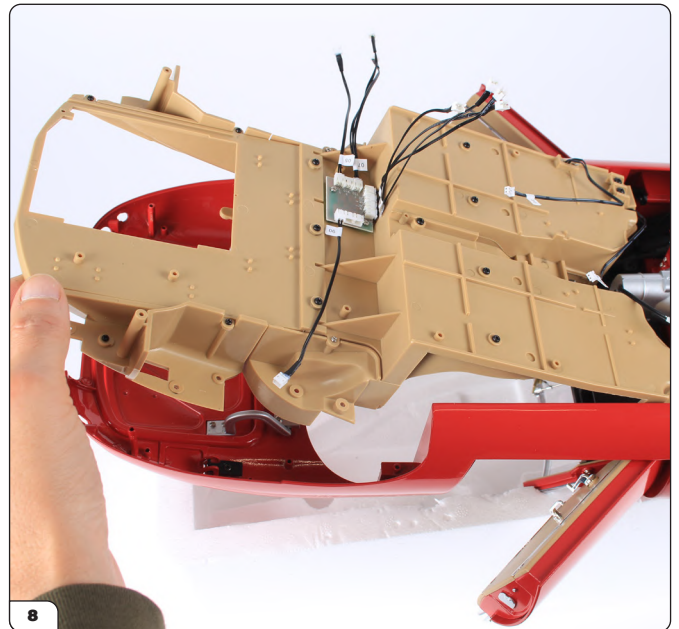

Place the body assembly upside down on a protective surface, then begin to slide the floor assembly into the body as shown.

## Stage 93: Fitting the Floor with the Electrical Circuit Board

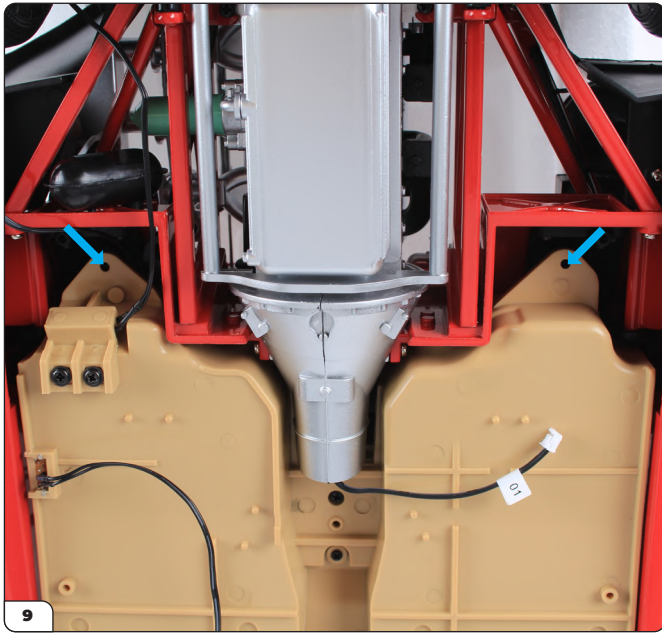

Slide the floor until the two screw holes (arrows) at the front of the car are aligned with the mounting plates below them.

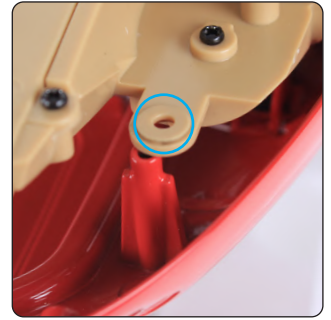
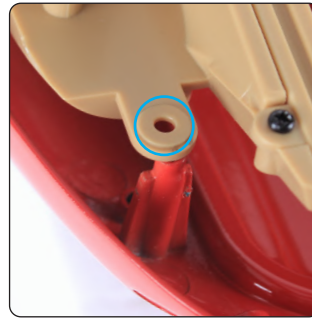

Note the four indicated areas at the rear of the car in the pictures above (circled) located around the boot. You'll need to bend the floor assembly slightly to fit these in place.

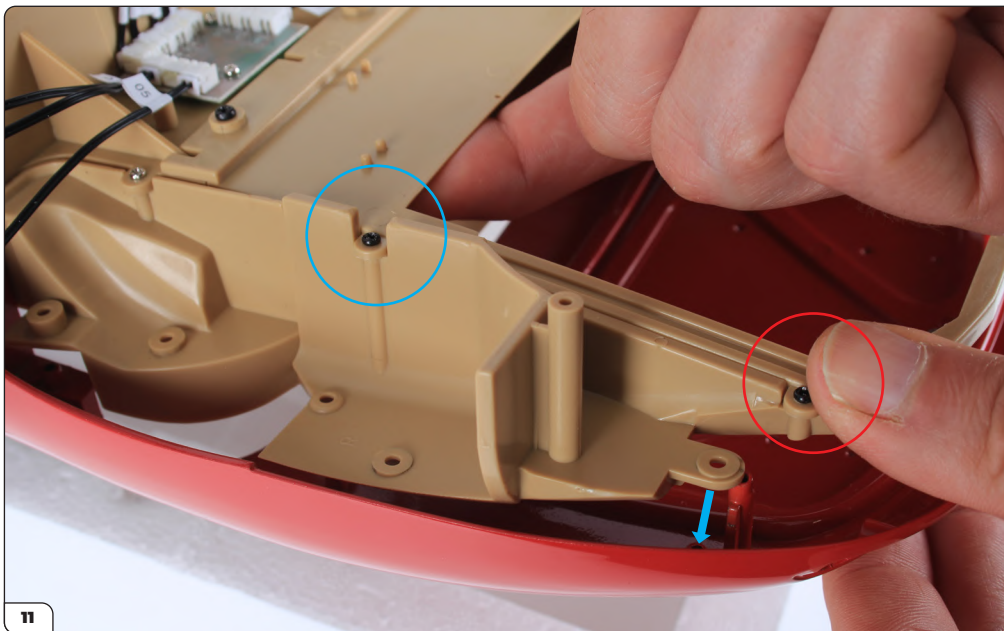

Holding the floor assembly as shown, apply some pressure with your thumb (circled, red) while supporting the floor with your finger (circled, blue). The screw hole indicated with the blue arrow fits into the recess of the body work (see photo 12).

## Stage 93: Fitting the Floor with the Electrical Circuit Board

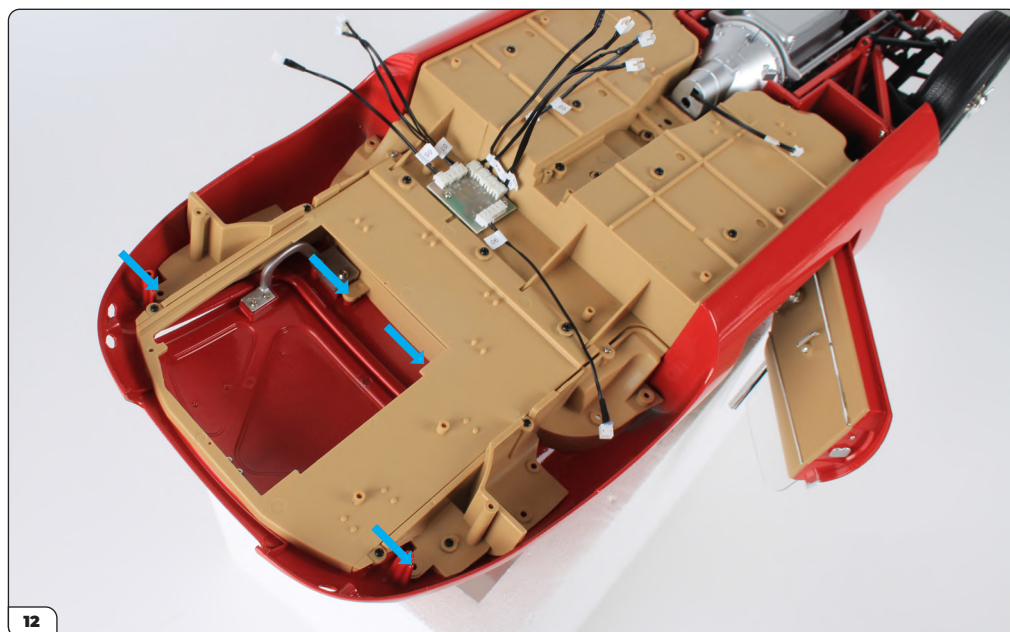

Repeat on the other side of the car to push all four connections into place (arrows).

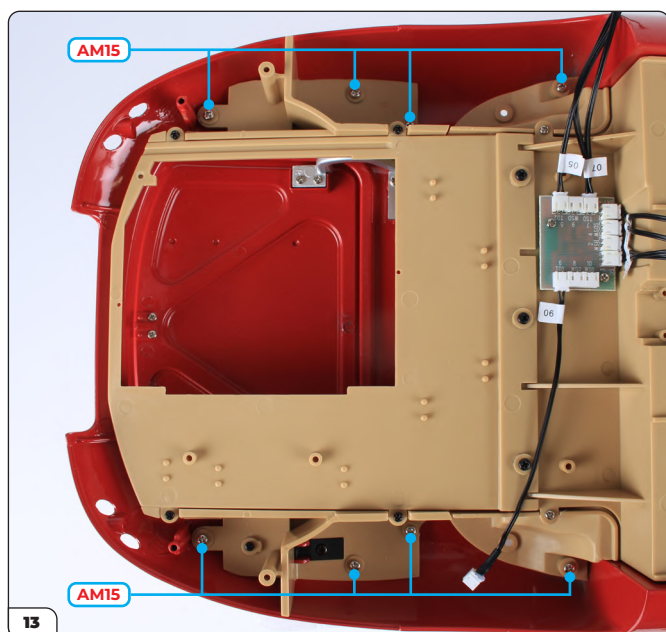

Secure the rear of the floor assembly in place using 8x AM15 screws.

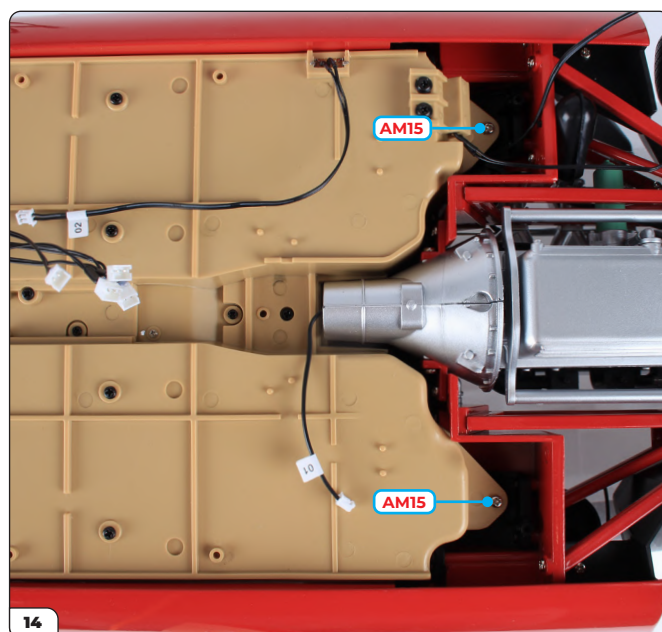

Secure the front of the floor assembly with 2x AM15 screws.



## Stage 93: Fitting the Floor with the Electrical Circuit Board

STAGE COMPLETE



# Stage 94: Securing the Tarpaulin

The rolled-down tarpaulin roof fits in behind the seats. This is fixed in place, so hopefully the sun is out today!



## STAGE 94 PARTS LIST

Name
Rolled tarpaulin
Screws type AG03 x3



## Stage 94: Securing the Tarpaulin



Take the body assembly and locate the three holes for the tarpaulin behind the seats (arrows).

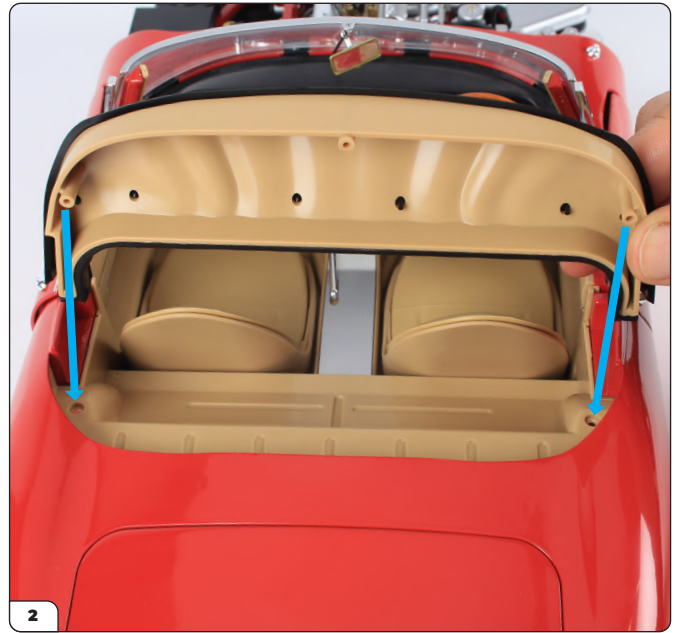

Align the tarpaulin (circled) with the body as shown.



Push the tarpaulin in place.

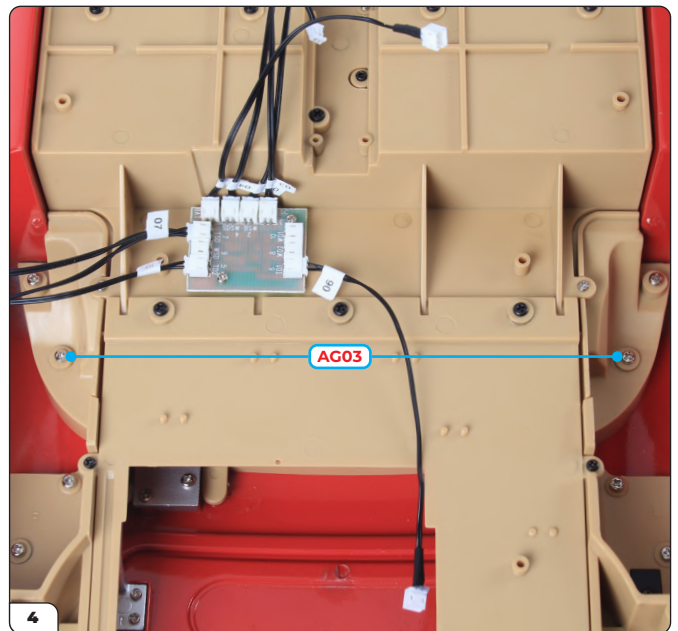

Fix the tarpaulin using 2x AG03 screws.

# Stage 94: Securing the Tarpaulin



## Stage 95: Installing the Prop Shaft and Left Rear Light

Next you'll start working on the rear bumper, first attaching the left light. There's also the prop shaft to install on the underside of the car, so prepare your protective surface for working on the underside.



### STAGE 95 PARTS LIST

Name
Front left bumper
Prop shaft
Rear left light
Rear left reflector lens
Screws type AG04 x4



## Stage 95: Installing the Prop Shaft and Left Rear Light



Take the left rear reflector lens and fit it into the left rear light using the D-shaped fitting.



Align the left rear light with the rear of the body as shown. Note the outline on the body shaped to fit the light.

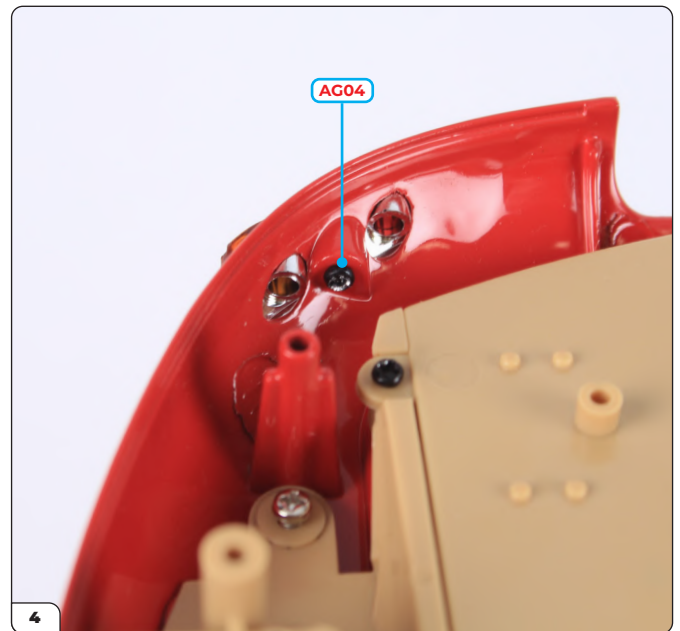

Fit the light in place, then secure it to the body by driving an AG04 screw through from inside the body.

# Stage 95: Installing the Prop Shaft and Left Rear Light



The left rear light should look like this.

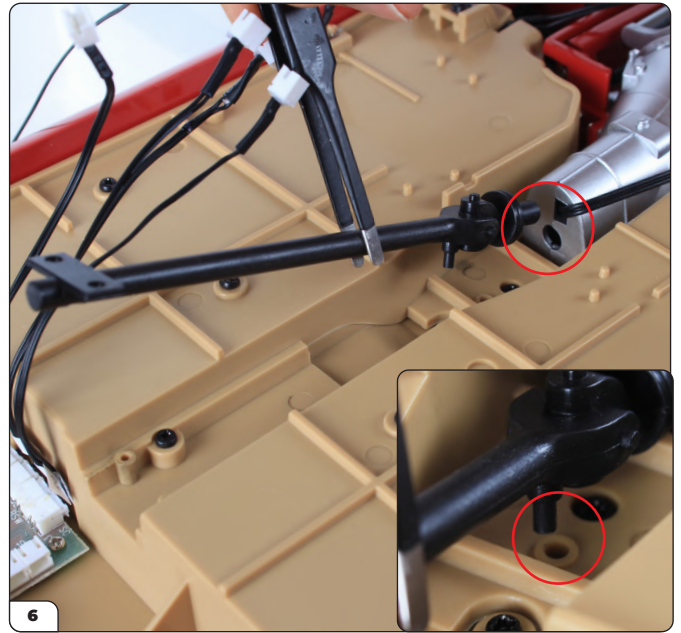

Next align the prop shaft with the underside of the car as shown. The end of the shaft will fit into the hole of the clutch bellhousing (circled). Note the peg and hole underneath the head of the prop shaft (inset, circled).

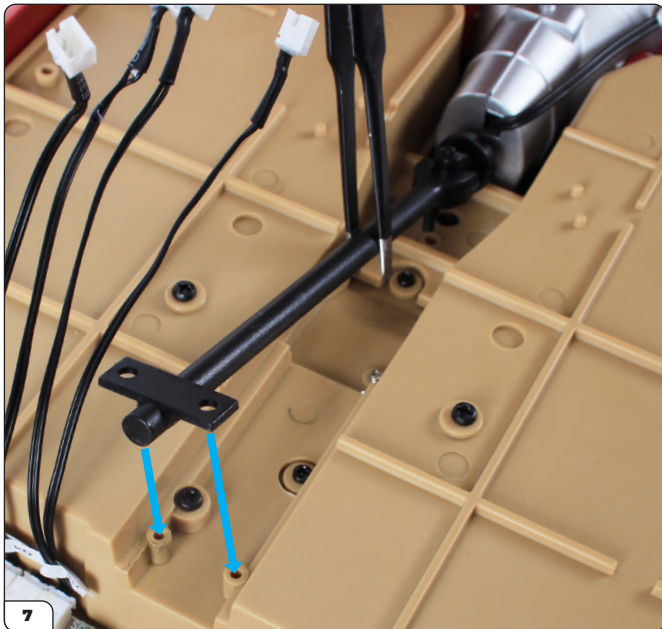

Insert the head of the prop shaft into the clutch bellhousing and bar at the other end of the prop shaft over the screw holes (arrows).

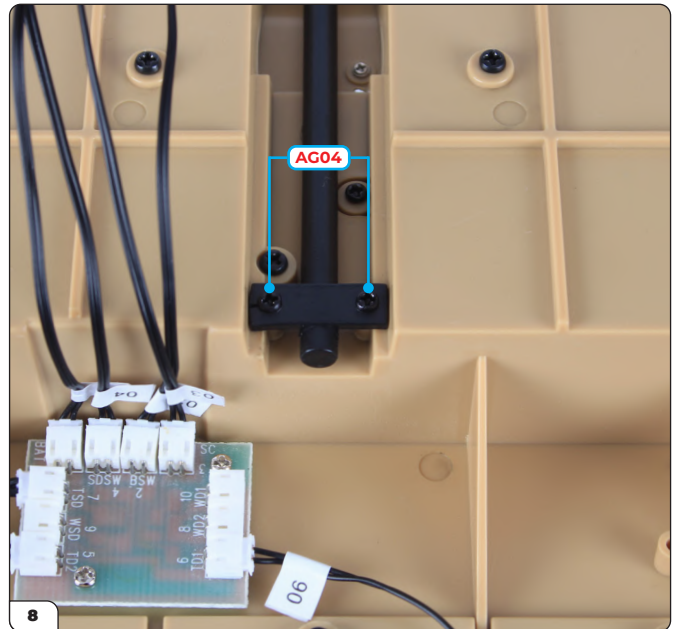

Fix the shaft using 2x AG04 screws.

## Stage 95: Installing the Prop Shaft and Left Rear Light

STAGE COMPLETE





# Stage 96: Connecting the Wiring, Right Rear Light, Fuel Tank, and Bonnet

Next is to install the right rear light, followed by the beautiful, sleek bonnet. You'll also connect and tidy up the wiring for all the electrical components of your Jaguar.

Make sure to test the electrics at the end of this stage!



## STAGE 96 PARTS LIST

Name
LEDs x3
Front right bumper
Rear right reflector lens
Rear right light
Sticky tape strip x4
Left bonnet mounting plate
Right bonnet mounting plate
Screws type AG04 x2
Screws type AG06 x5
Screws type AM15 x5

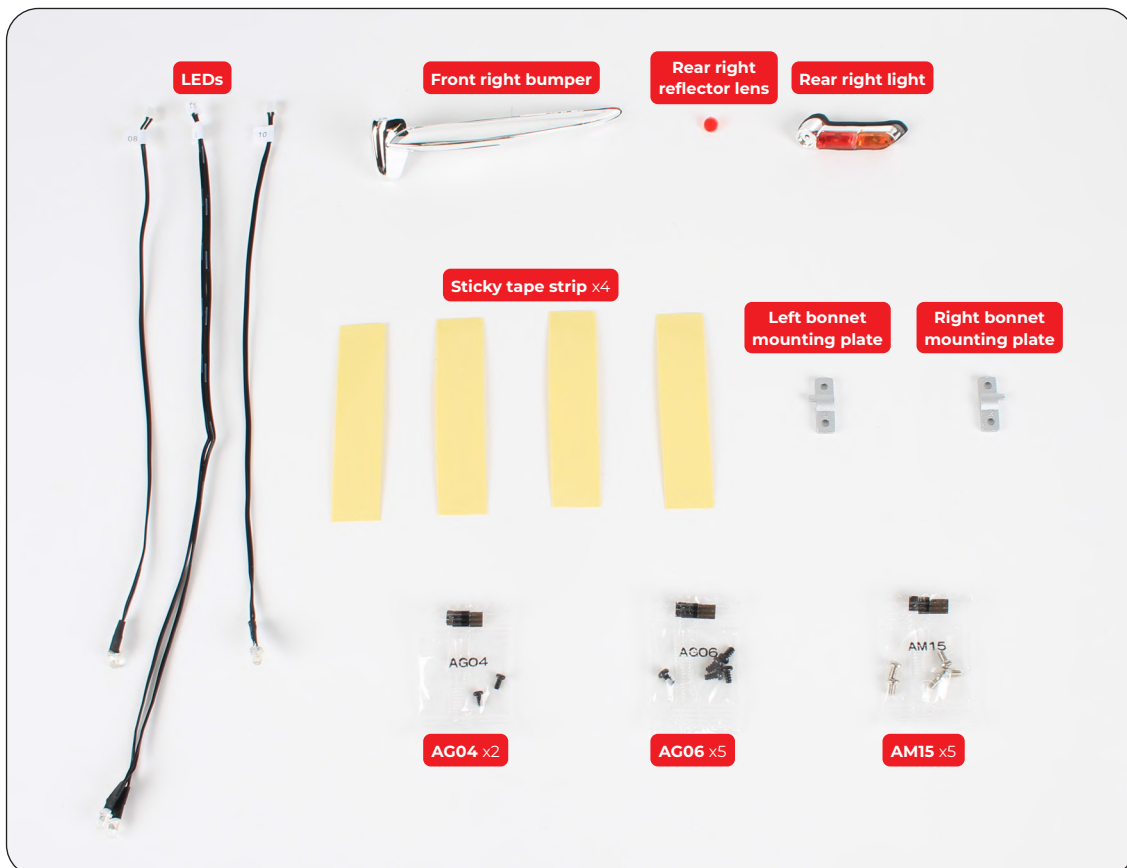

## Stage 96: Connecting the Wiring, Right Rear Light, Fuel Tank, and Bonnet



Take the right rear reflector lens and fit it into the right rear light using the D-shaped fitting.

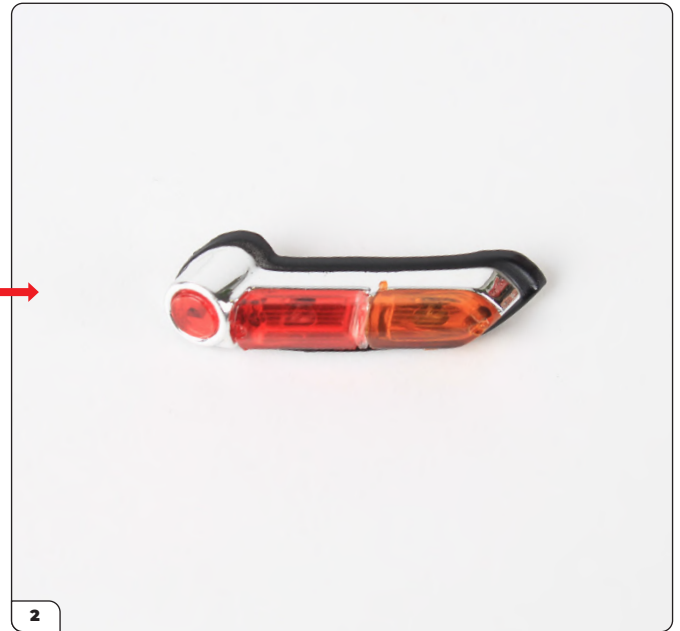

Align the rear light with the rear of the body as shown. Note the outline on the body shaped to fit the light.

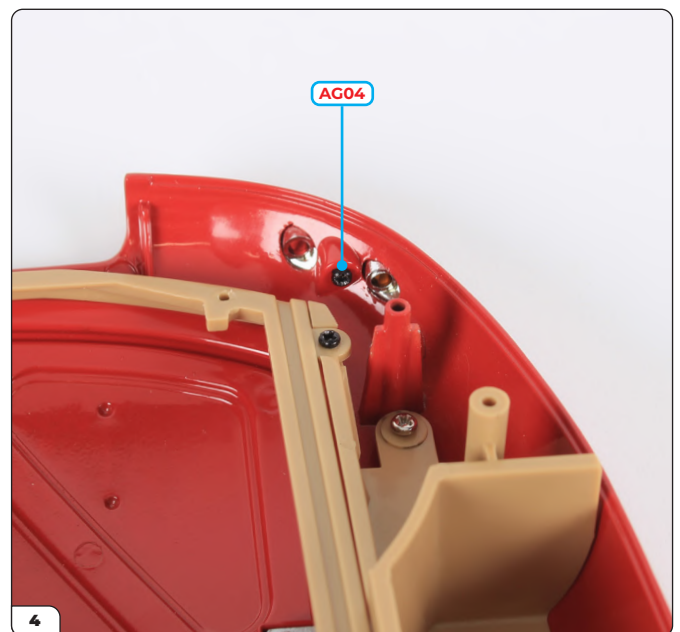

Fit the light in place, then secure it to the body by driving an AG04 screw through from inside the body.

# Stage 96: Connecting the Wiring, Right Rear Light, Fuel Tank, and Bonnet



Both rear lights have been fitted to the body.



Next you will mount the bonnet onto the body. Take the two mounting body plates, and identify the left from the right using the 'L' and 'R' marked on the parts (circled).

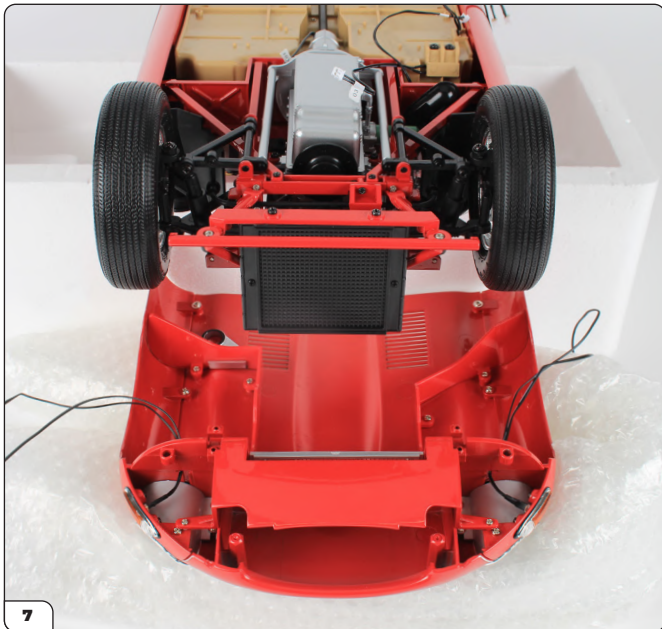

Place the bonnet assembly on a protective work surface, then mount the body assembly above it. Here we've used the packaging from Stage 84 to mount the body.

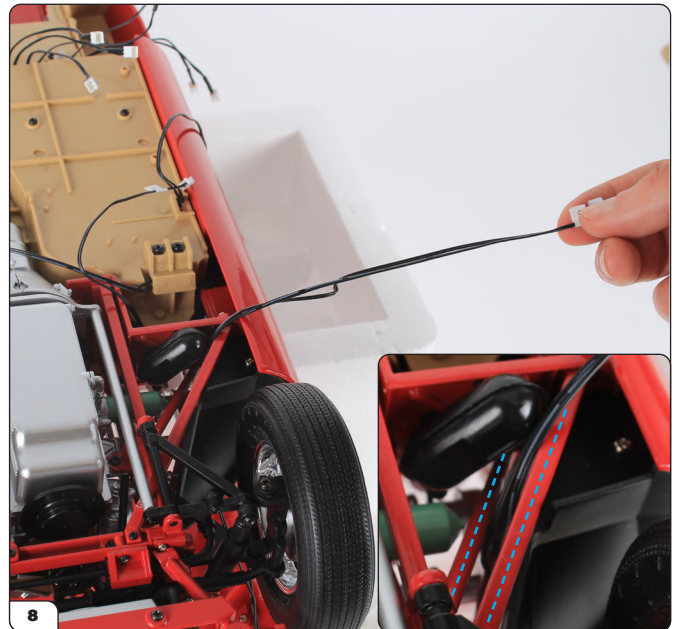

Thread the right LED light wire through the frame of the engine as shown. The wire should go between the two bars marked by dashed blue lines shown in the inset image.

## Stage 96: Connecting the Wiring, Right Rear Light, Fuel Tank, and Bonnet



9 Thread the left LED light wires through the opening in the frame as shown.



10 With the LED light wires threaded through, the bonnet can now be lifted into place and attached.

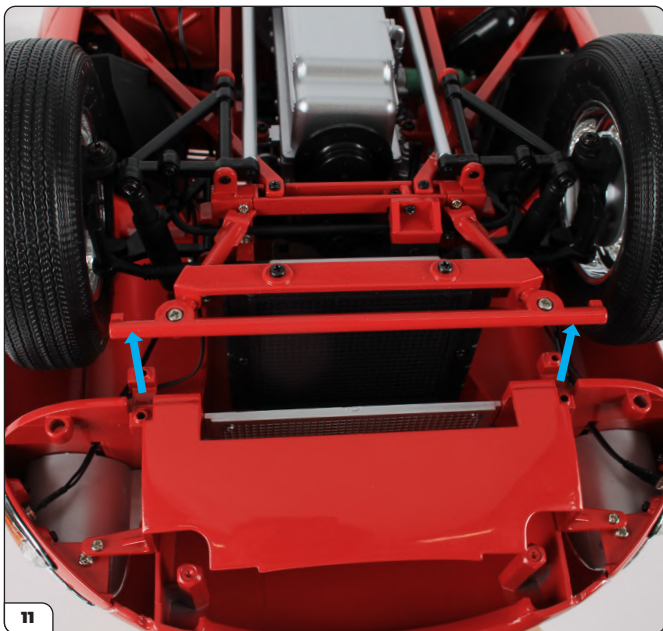

11 Carefully lift the bonnet until the hinges at the front are placed over the bar along the frame (arrows).

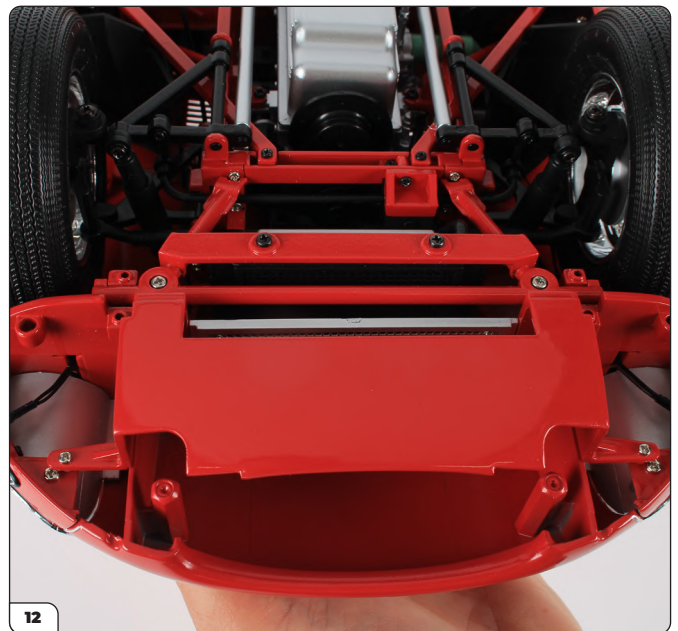

12 Hold the bonnet in place.

## Stage 96: Connecting the Wiring, Right Rear Light, Fuel Tank, and Bonnet

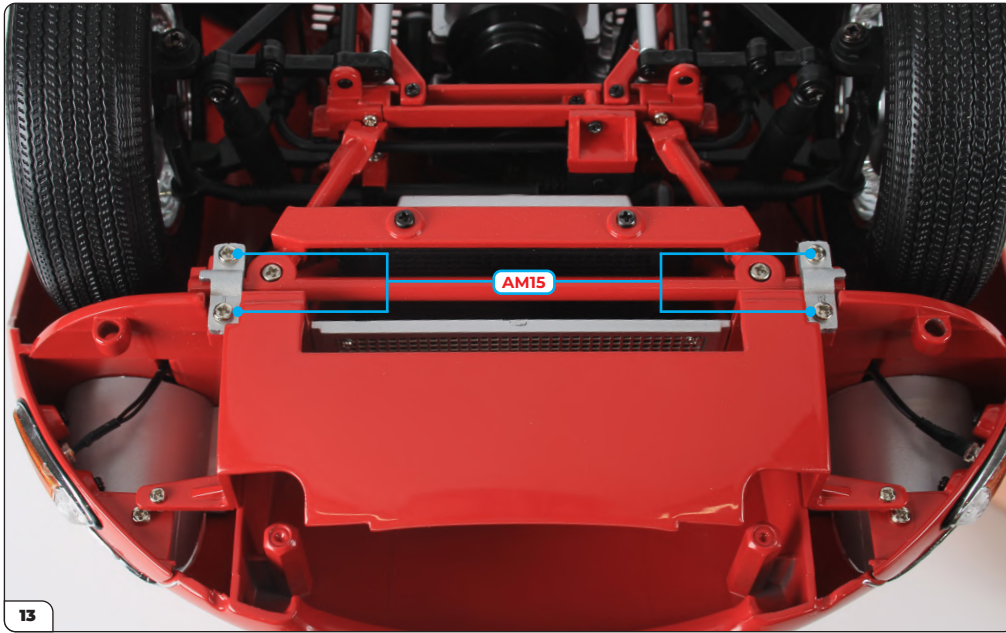

While keeping the bonnet in place, fit the left and right mounting plates then fix the parts together using 4x AM15 screws.

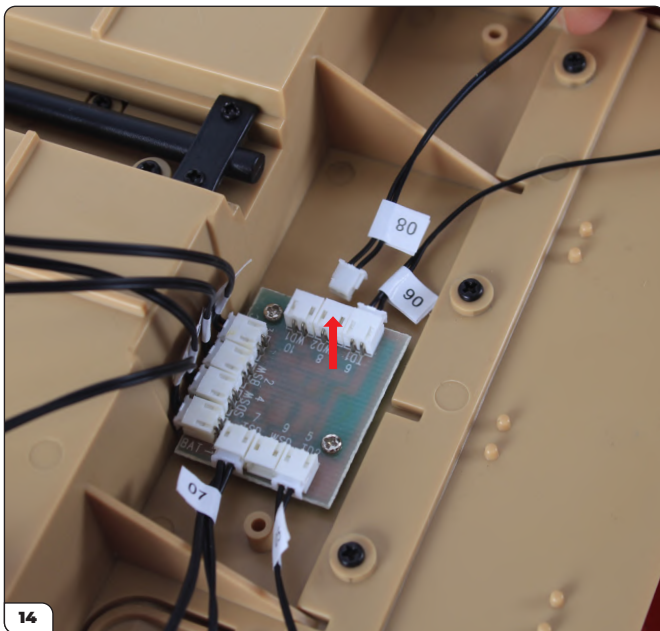

Take the wire marked '08' and plug it into the socket marked '8' on the circuit board.

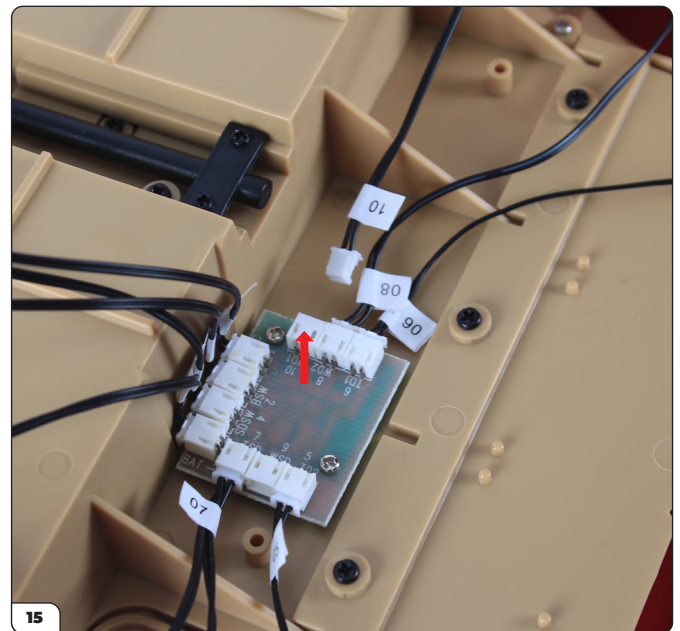

Then plug the wire marked '10' into socket '10'.

# Stage 96: Connecting the Wiring, Right Rear Light, Fuel Tank, and Bonnet

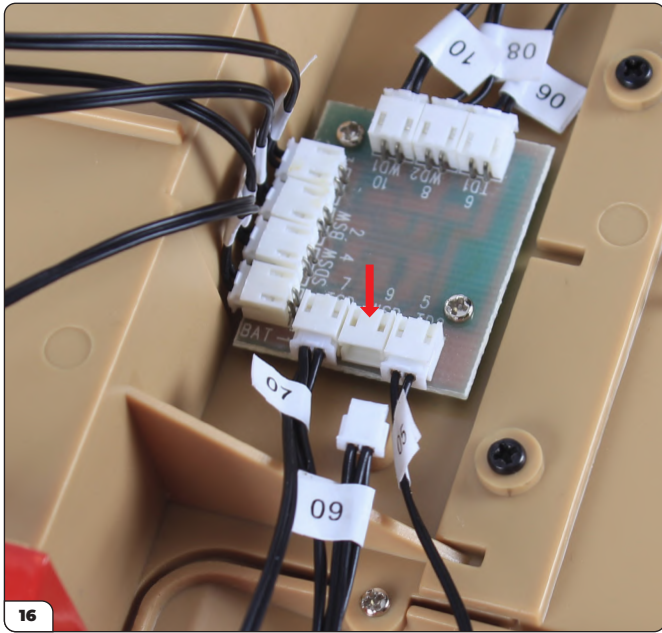

Followed by wire '09' into socket '9'. With all the wires plugged into the circuit board, you'll now need to connect them all up.

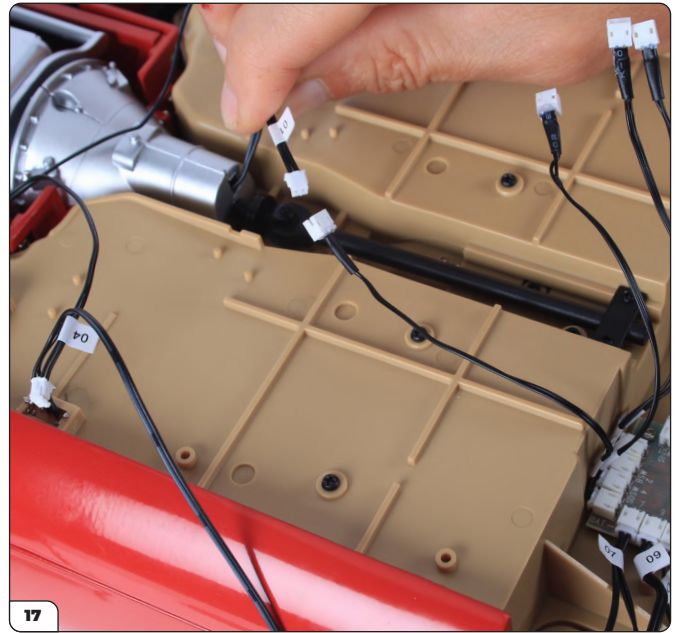

Take the wire marked '01' from the clutch bellhousing and plug it into the wire marked '01' connected to circuit board. Continue matching up all the loose wires until they are all connected to the circuit board.



Take the bulb end of the LED (wire '10') and push it into the inner slot of the rear right light as shown.



Then take one of the LEDs (wire '06') and push it through the outer slot of the rear right light.

# Stage 96: Connecting the Wiring, Right Rear Light, Fuel Tank, and Bonnet



Take the bulb end of the LED (wire '08') and push it into the inner slot of the rear left light as shown.

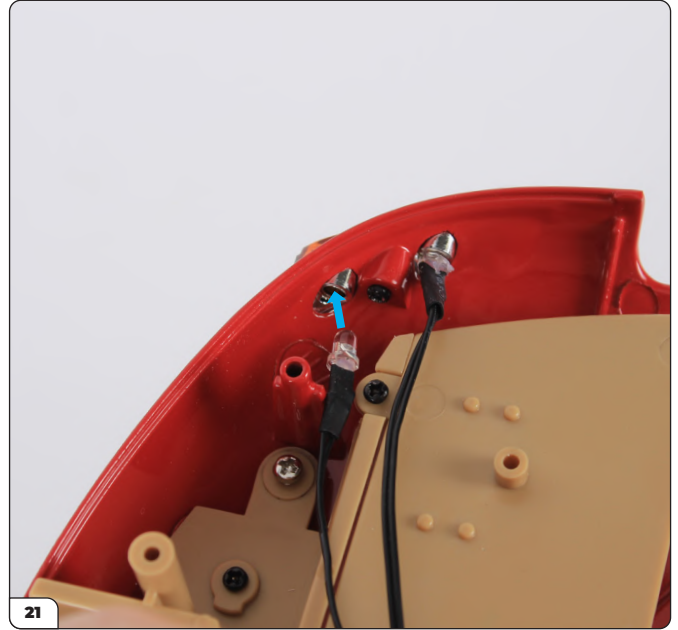

Then take the remaining LED from wire '06' and push it through the outer slot of the rear left light.

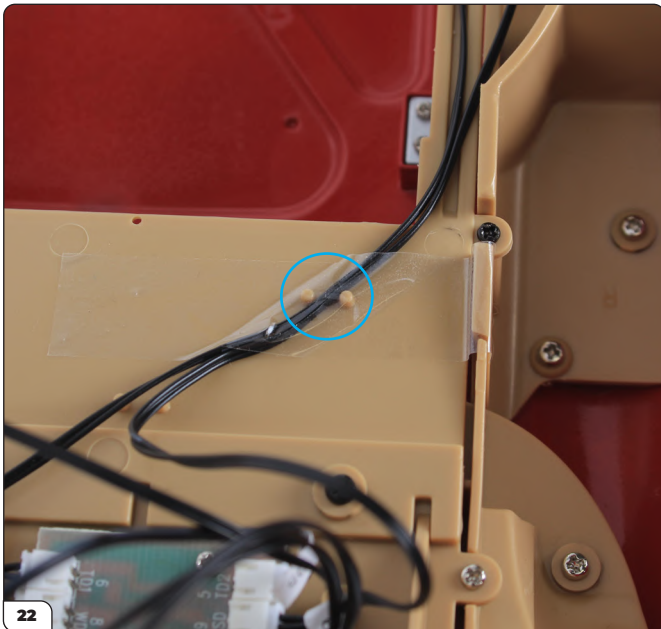

To keep the wires tidy before you attach the wheel base onto the body, use the pegs (circled) to guide the wires. Stick the wires in place using a strip of the sticky tape provided. We recommend cutting the strips in half so that you can stick the wires down at other points as needed.

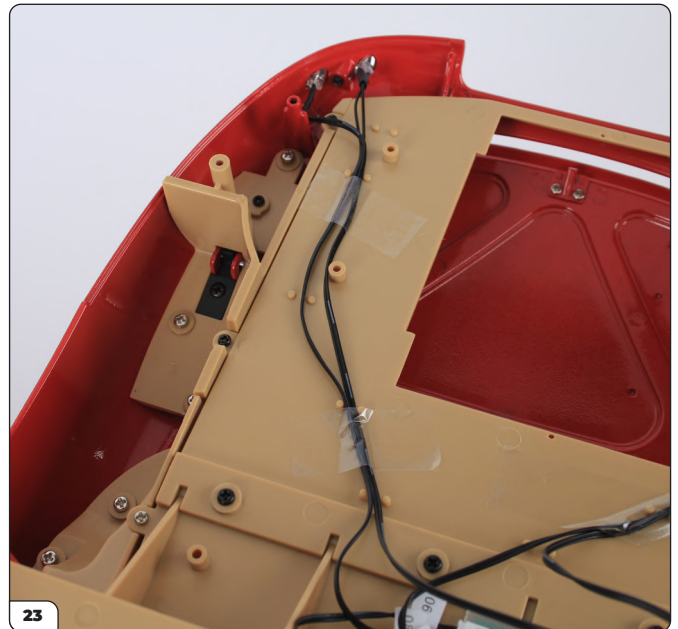

Repeat for the wires from the other rear light, using the guides and then sticking the wires in place with a strip of tape.

## Stage 96: Connecting the Wiring, Right Rear Light, Fuel Tank, and Bonnet

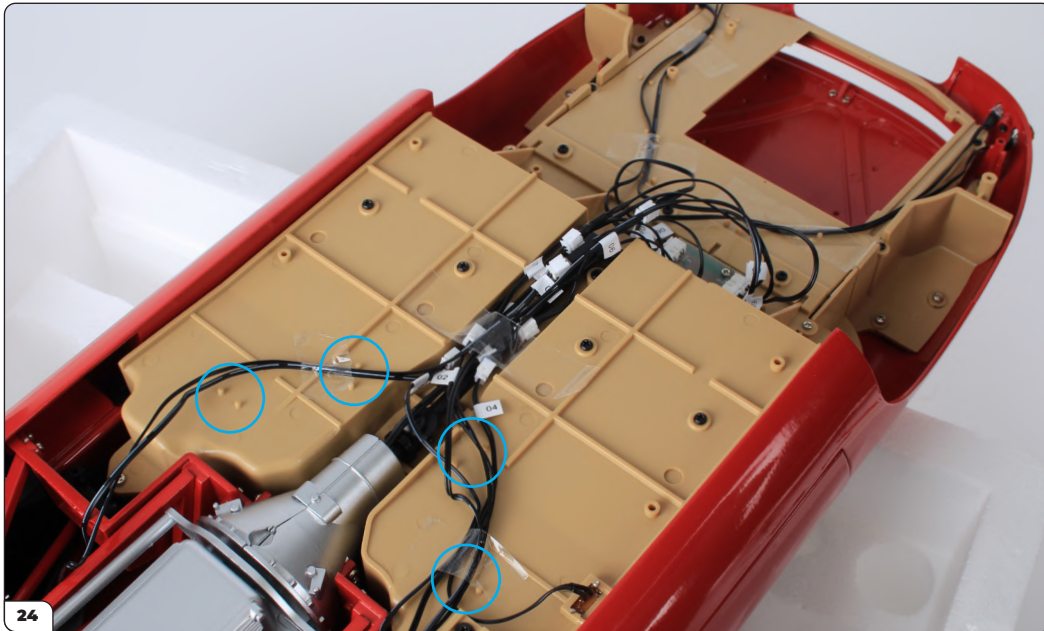

Bundle the wires to the front of the car into the guides (circled) and the transmission tunnel, then stick with tape as needed.

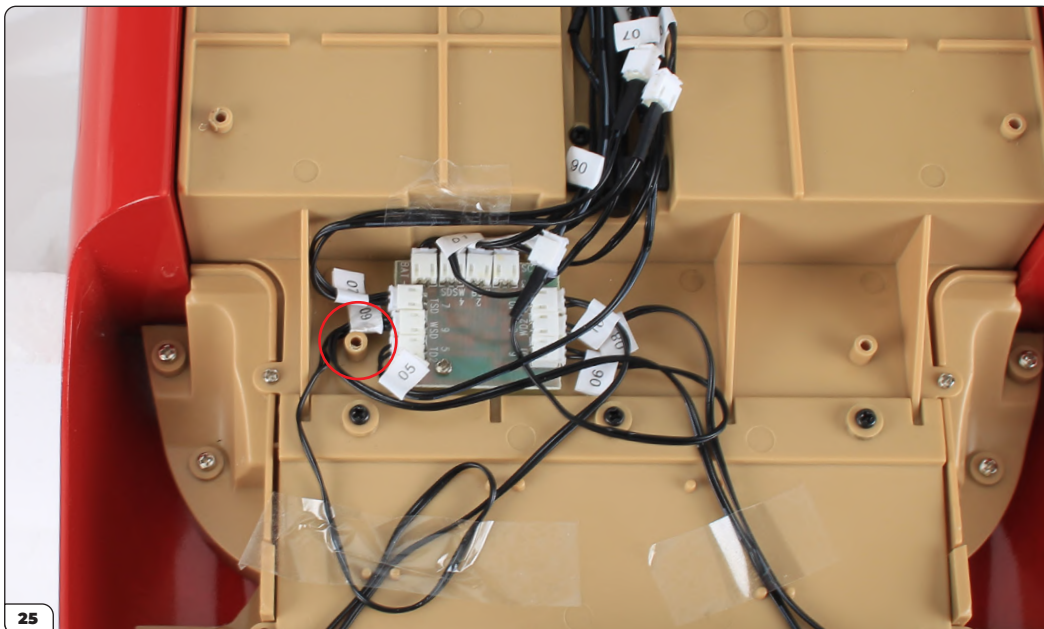

Check that the screw hole (circled) next to the circuit board does not have any wires covering it.



## Stage 96: Connecting the Wiring, Right Rear Light, Fuel Tank, and Bonnet

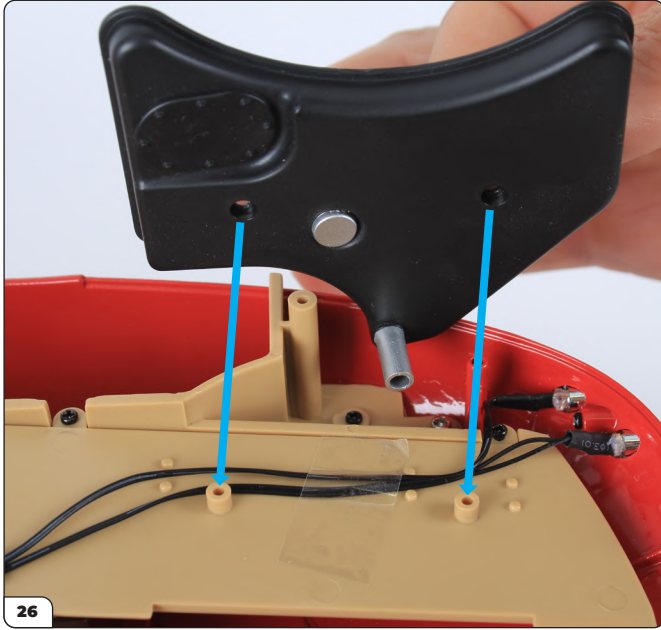

Next take the fuel tank top from Stage 68 and align it with the holes at the rear left of the assembly as shown.



Secure the top of the tank to the body using 2x AG06 screws.

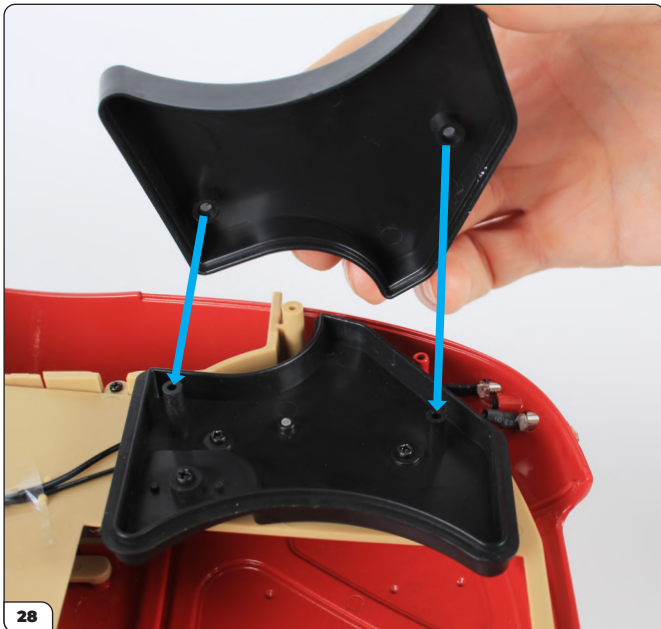

Next take the fuel tank bottom from Stage 68 and place it onto the top of the tank as shown.



Attach the two parts of the fuel tank together by driving 2x AG06 screws through the two holes indicated with red arrows.

## Stage 96: Connecting the Wiring, Right Rear Light, Fuel Tank, and Bonnet

---

STAGE COMPLETE



## Advice from the experts



We recommend testing the electrics at this point of your build to ensure everything is connected and working correctly. Note we have used the completed model for these photos!

The switch in the driver's footwell (circled) controls the headlights. Flip the switch on and off to test.



Both headlights should illuminate while the switch is turned on.



Push the brake pedal (arrow) to turn on the brake lights.



Both brake lights illuminate while the brake pedal is pushed.

## Advice from the experts



Push the button on the dashboard to the right of the steering wheel (arrow) to activate the hazard lights.



Both of the rear hazard lights will blink five times after the button is pushed...



... as will the two front hazard lights.

If any of the lights don't illuminate, check that the wiring hasn't come loose during assembly and that the wire has been plugged correctly into the circuit board. If none of the lights work, check the batteries are installed correctly.

## Stage 97: Attaching the Front Bumper and Underside

Now it's time to work on the front bumper and fit the iconic growler badge! You'll also fit the underside with the rear wheels, just make sure to check the wires are all out the way before screwing it in.



### STAGE 97 PARTS LIST

Name
Bonnet under panel
Screws type AM01 x3
Screws type AG02 x5
Screws type AG06 x9
Screws type AG09 x3



## Stage 97: Attaching the Front Bumper and Underside



Along with the body, you'll need the underside subframe assembly from Stage 81 and the motif bar from Stage 23.

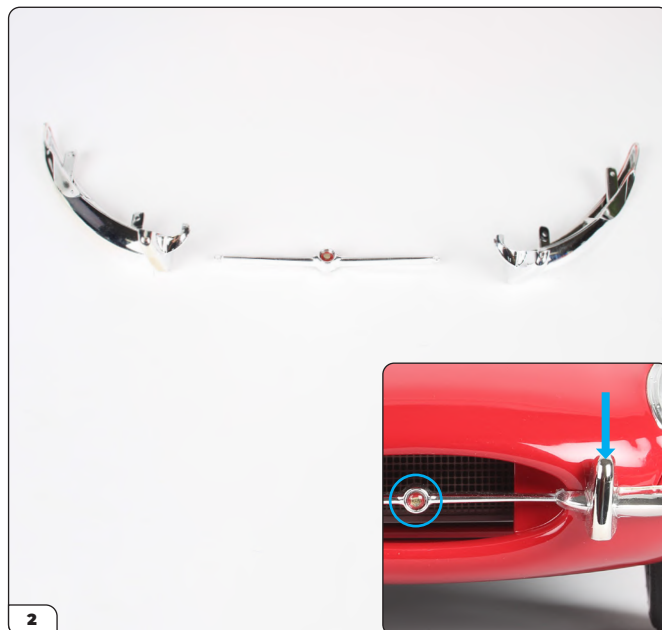

Align the motif bar and the two front bumpers from Stage 95 and Stage 96 as shown. Note the rounded end of the bumper points upward (inset, arrow). When fitting the parts together in the next steps, make sure the Jaguar growler badge is upright (inset, circled).

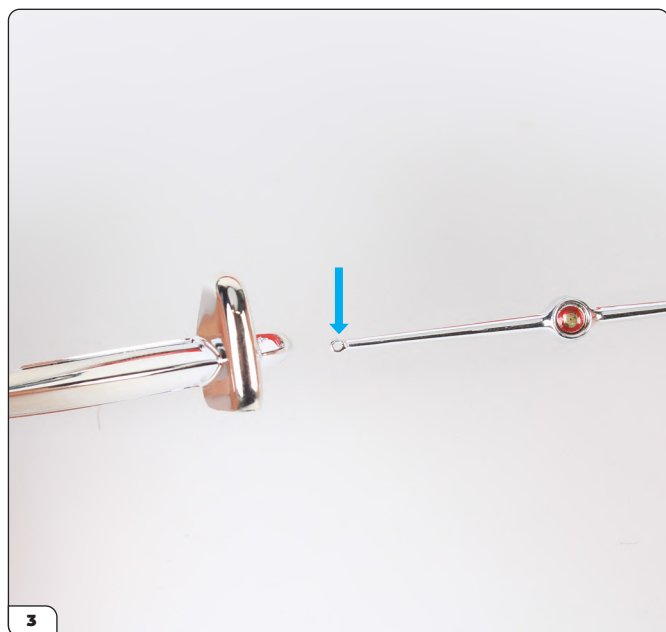

Each end of the motif bar has a small eyelet for hooking onto the front bumper (arrow).

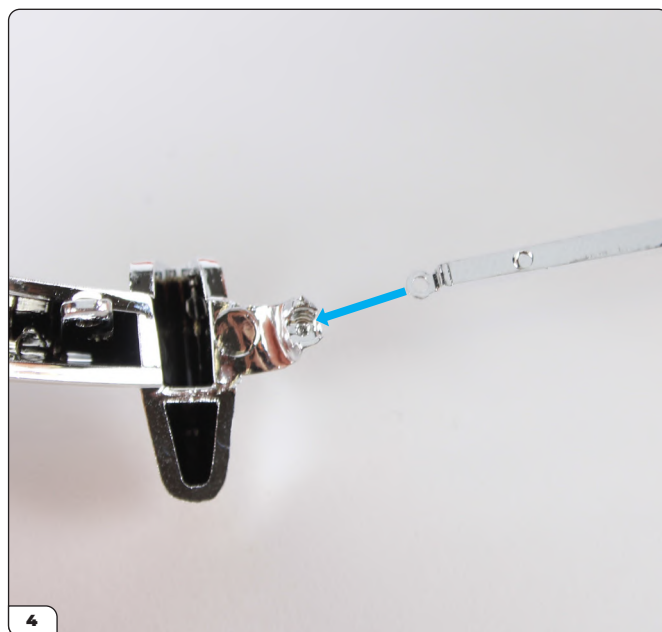

Flip the motif bar and bumper over, then fit the eyelet onto the front bumper as shown.

## Stage 97: Attaching the Front Bumper and Underside

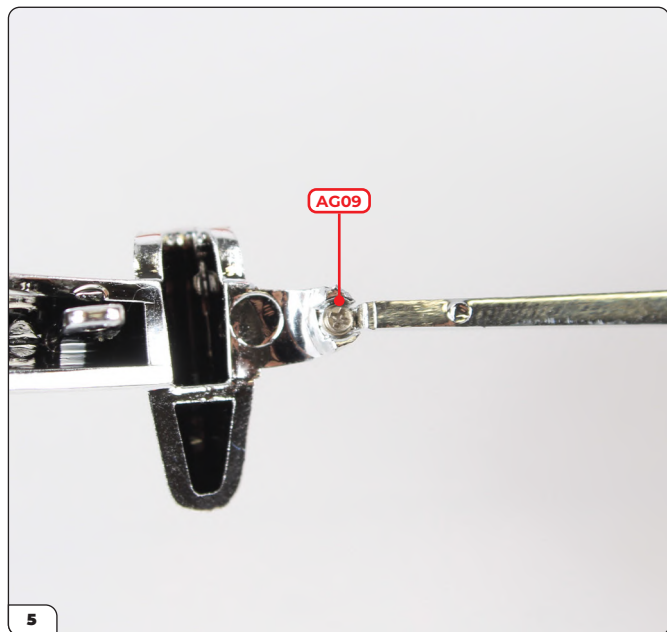

Fit the motif bar onto the bumper and attach using an AG09 screw.

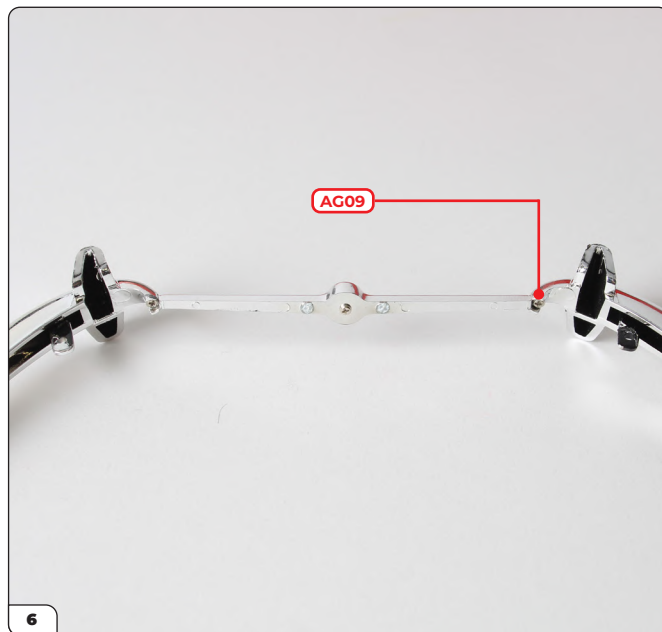

Repeat for the other bumper, attaching with another AG09 screw.



The front bumpers and motif bar should look like this once assembled. The inset shows the Jaguar growler badge.

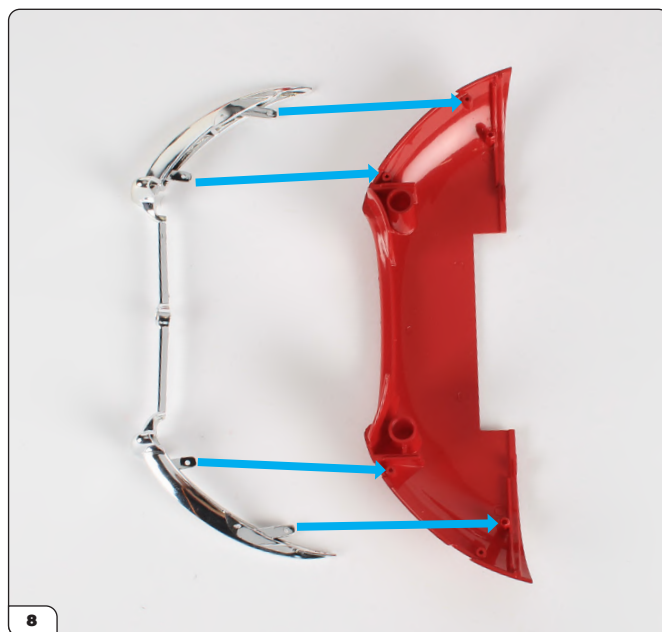

Now take the bonnet under panel and align the front bumper assembly with it as shown.

## Stage 97: Attaching the Front Bumper and Underside

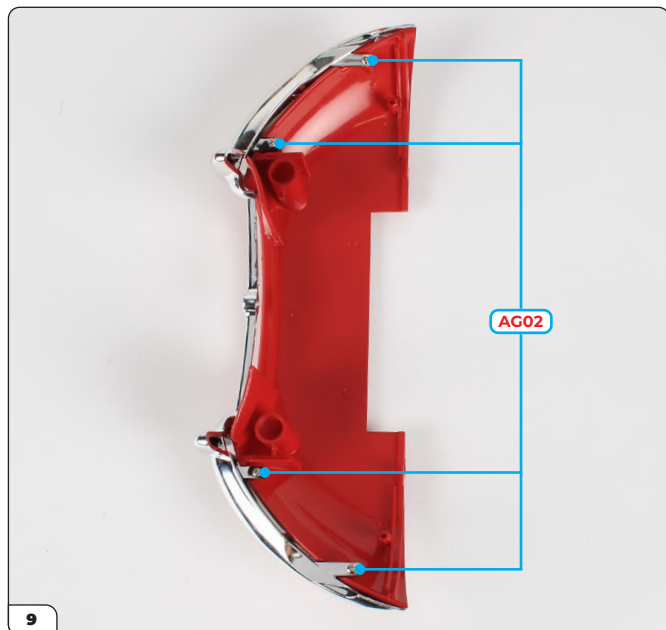

Fix the bumper to the under panel using 4x AG02 screws.



The front bumper assembly should now look like this.

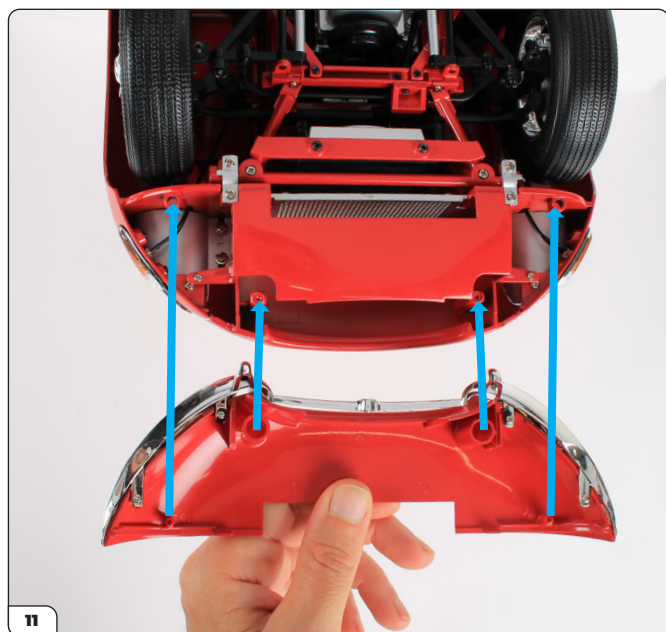

Mount the body of the car upside down on a protective surface. Locate the mounting holes and pillars on the underside of the body that correspond with those on the bumper assembly (arrows).



Firmly press the bumper into place.



## Stage 97: Attaching the Front Bumper and Underside

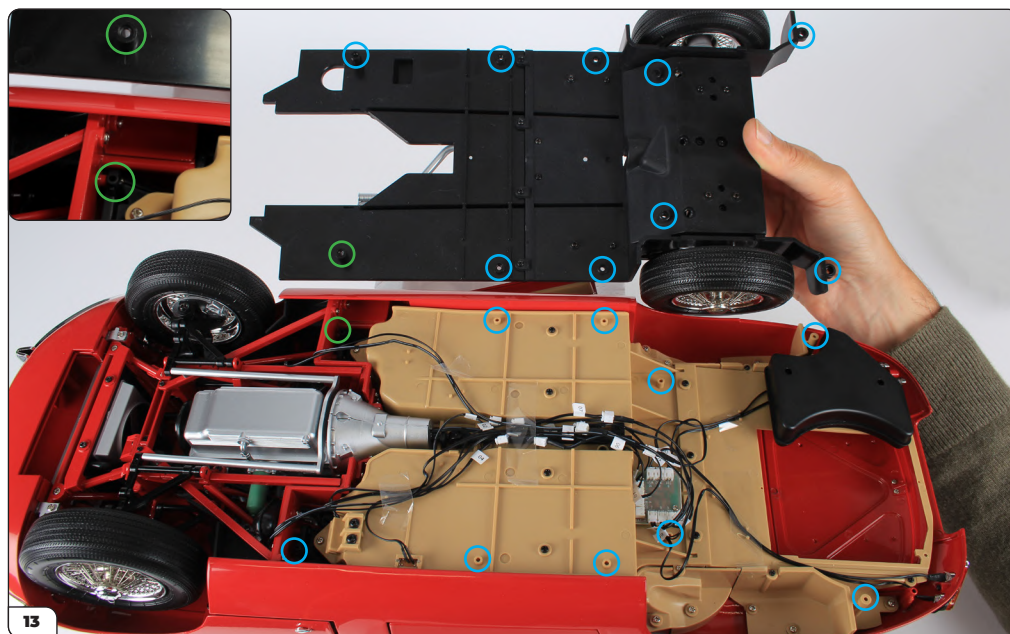

Next take the underside subframe assembly and locate all the fixing points for attaching it to the body (circled). The inset shows a clearer image of the fixing points circled in green.

Check all screw holes on the body to ensure that none of the wires are at risk of getting damaged when screwing the underside on!



Lower the underside subframe into place as shown, starting with the fixing points at the front of the car.

## Stage 97: Attaching the Front Bumper and Underside



The bottom of the car should look like this with the subframe in place.

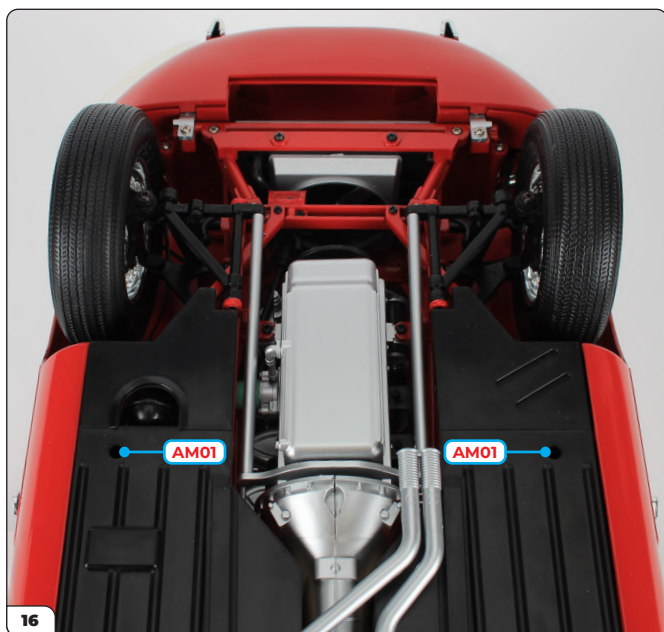

Start fixing the underside to the body using 2x AM01 screws on the fixing points at the front of the car.

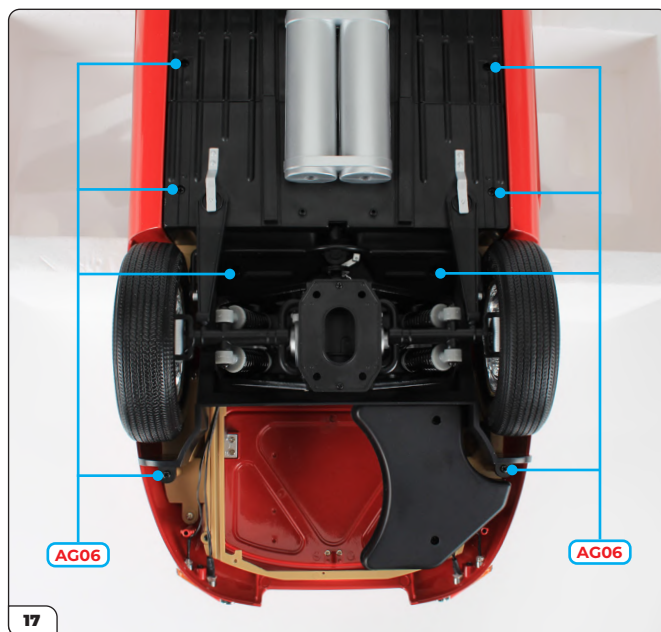

Finish fixing the underside by driving 8x AG06 screws into the fixing points at the rear of the car.

## Stage 97: Attaching the Front Bumper and Underside

---

STAGE COMPLETE



## Stage 98: Rear End Panel

There's no assembly at this stage, unpack the parts and move straight on to the next stage.



### STAGE 98 PARTS LIST

Name
Rear end panel
Left screw cover
Right screw cover



## Stage 99: Fitting the Rear End Panel

You'll now fit the last piece of the beautiful E-type body, adding the bumpers, license plate and other details onto the rear end panel.



### STAGE 99 PARTS LIST

Name
Rear left bumper
Rear right bumper
Reverse lamp
Rear license plate lamp (left and right)
Spare wheel clamp
Tank sump
Reverse lamp lens
Rear license plate
Screws type AG03 x5
Screws type AM15 x7



## Stage 99: Fitting the Rear End Panel

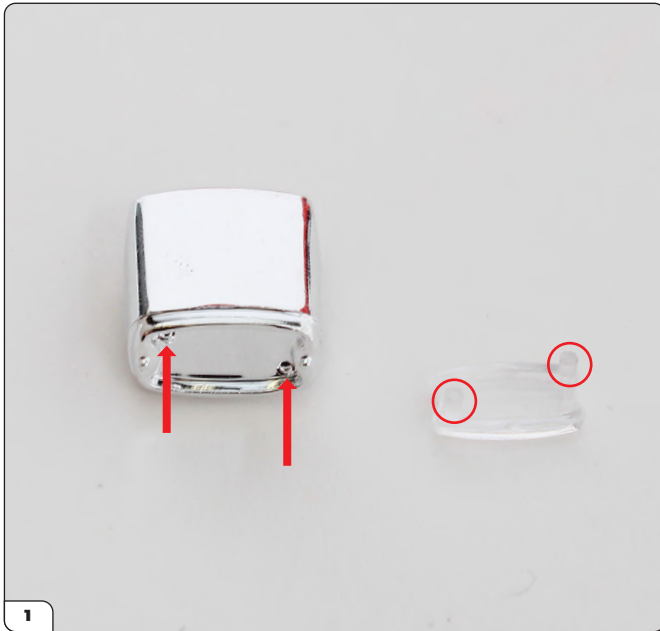

Take the reverse lamp and its lens. Note the holes on the lamp (arrows) and the pegs on the lens (circled) for fitting the parts together.

You may need to use a sharp knife to remove excess paint from inside the holes of the lamp.



Firmly press the lens into the reverse lamp using the pegs and holes as a guide.



Align the reverse lamp with the three holes on the rear end panel from Stage 98 as shown. Fit the lamp in place (inset).



Holding the lamp in place, turn the panel over and secure the parts together using an AG03 screw.

## Stage 99: Fitting the Rear End Panel



5  
Next take the tank sump and fit it into place in the D-shaped hole on the rear end panel.



6  
Hold the sump in place and secure it to the panel by driving an AG03 screw through from underneath.

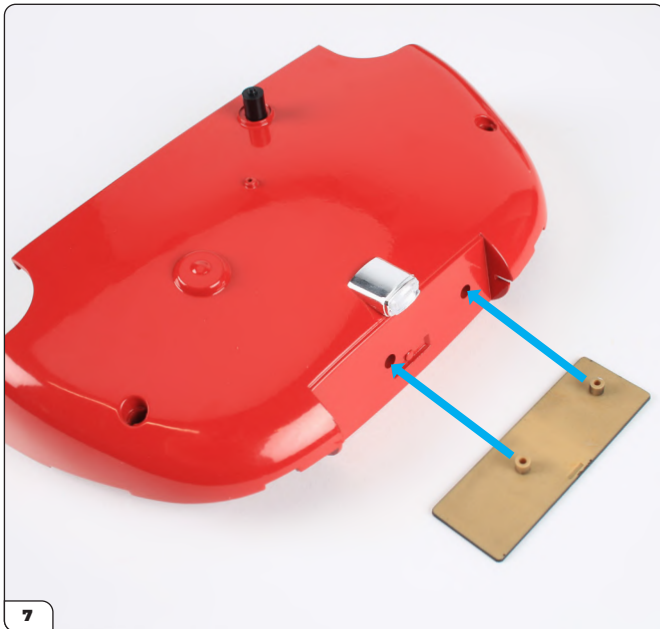

7  
Now take the license plate and align the two screw holes on the back with the rear end panel as shown.



8  
Fit the license plate onto the rear end panel then secure it in place using 2x AG03 screws.

## Stage 99: Fitting the Rear End Panel



The rear end panel should now look like this with the reverse lamp, sump tank and license plate attached.



Turn the rear end panel upright and align the right rear license plate lamp. Test fit the two lamps to tell them apart. When fitted, the rounded end should face inwards, with the flat end pressed against the license plate. The inset shows the right lamp pressed into the slot.

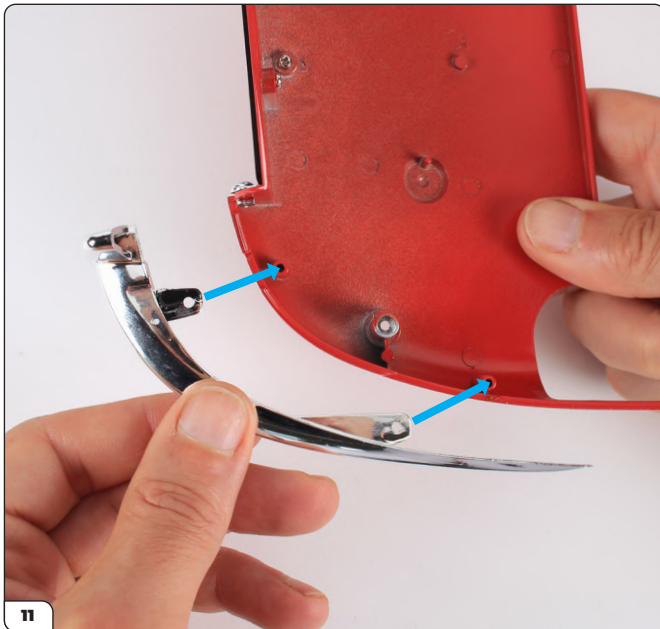

Now align the rear right bumper with the end panel.



Fix the rear right bumper to the end panel using 2x AM15 screws.



## Stage 99: Fitting the Rear End Panel



Fit the left license plate lamp into the slot in the same manner.



Press the rear left bumper into place then fix it using 2x AM 15 screws.



The spare wheel from Stage 25 fits onto the holder indicated by the blue arrow. Fit the centre of the wheel over the holder.

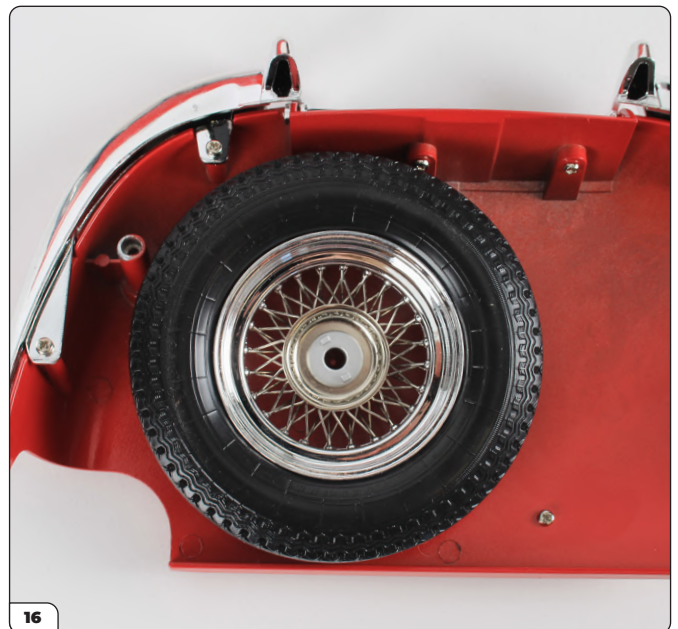

You may wish to fit the wheel once you have completed assembly of this stage, as it can make attaching the panel a bit more difficult.

## Stage 99: Fitting the Rear End Panel



Press the spare wheel clamp through the centre to secure the wheel.



Mount the body on a protective surface. Locate the fixing points for the rear end panel (arrows).



Press the rear panel into position, then secure it using 2x AM15 screws driven through the holes.

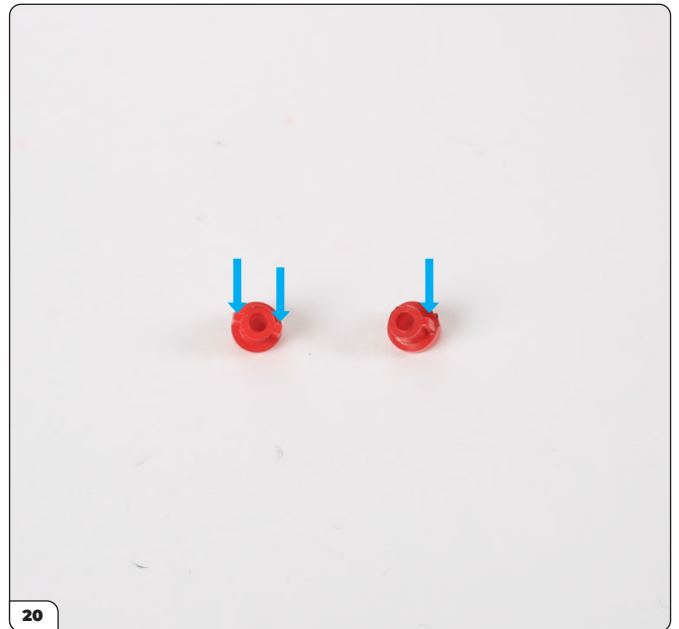

Take the two screw covers from Stage 98. Note they have different fittings, one with a single bar and the other with two bars (arrows).

## Stage 99: Fitting the Rear End Panel

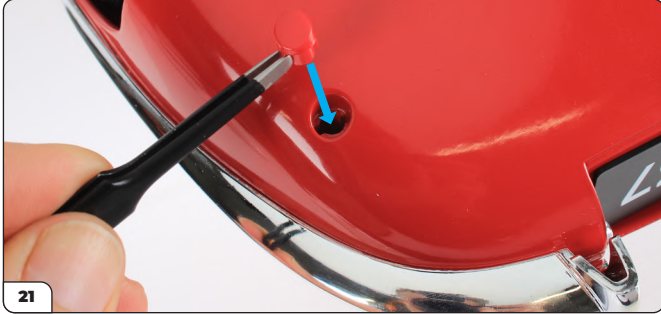

21

Fit the covers into the corresponding holes on the rear end panel.



22

The screw covers should be flush with the panel when fitted.

STAGE COMPLETE



# Stage 100: Installing the Exhaust Pipes

For the final stage of your build, all that's left is to install the exhaust on the underside of the Jaguar E-type, then it's build complete!



## STAGE 100 PARTS LIST

Name
Exhaust line
Exhaust line top part
Front pipe (1)
Front pipe (2)
Screws type AG02 x5
Screws type AM03 x2



## Stage 100: Installing the Exhaust Pipes

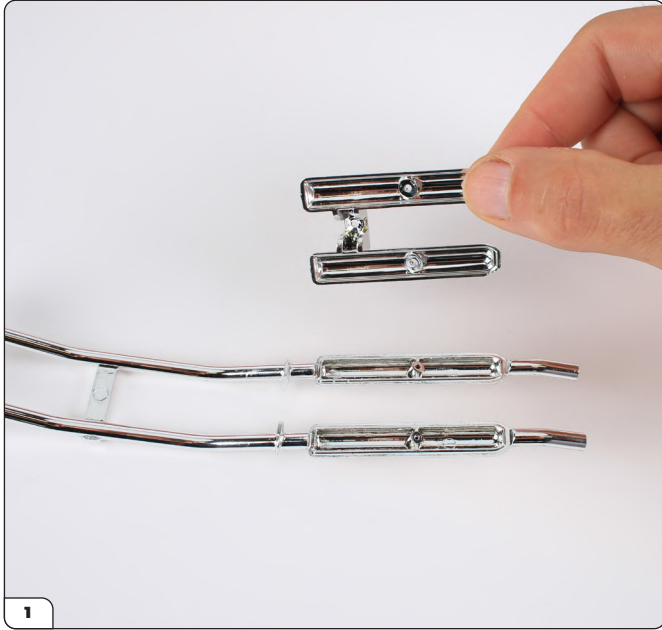

Align the top part with the exhaust line as shown.

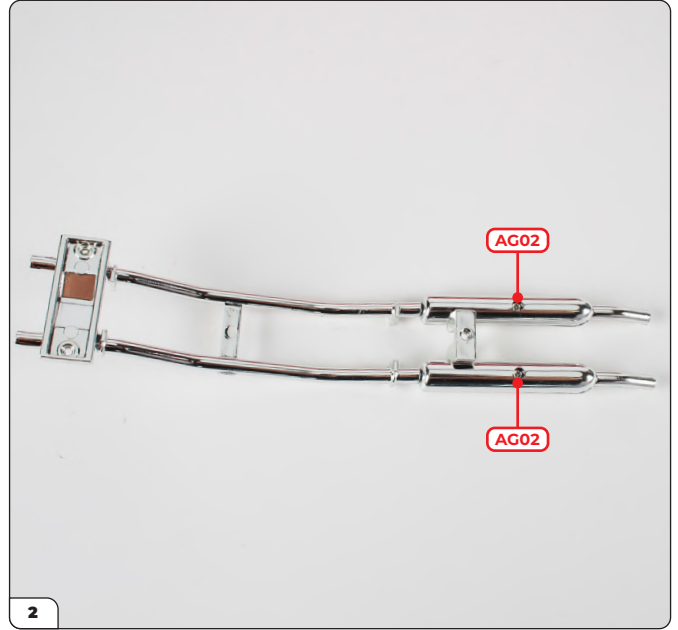

Place the top onto the exhaust line and secure together using 2x AG02 screws.

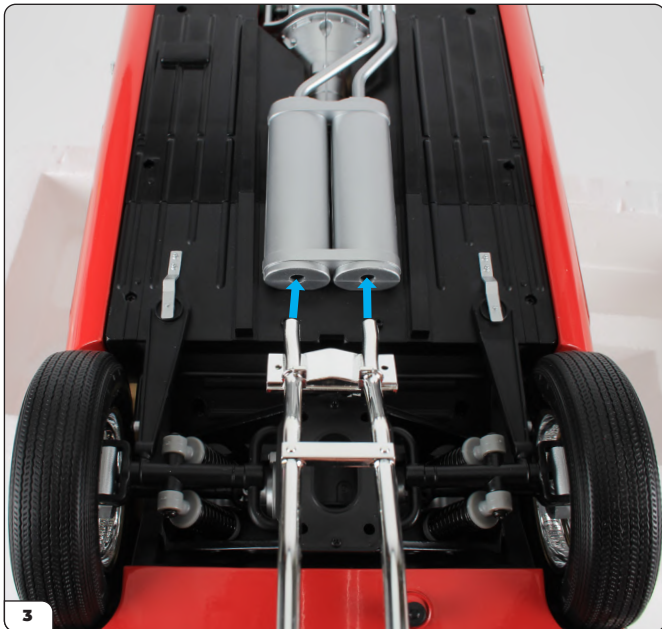

Push the ends of the exhaust line into the silencer as shown.

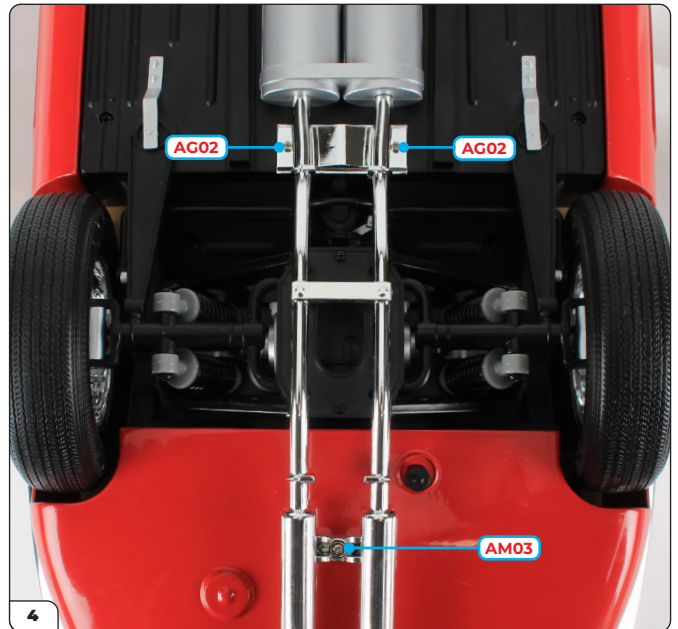

Adjust the exhaust line until the screw holes are in place, then secure using 1x AM03 and 2x AG02 screws.

## Stage 100: Installing the Exhaust Pipes

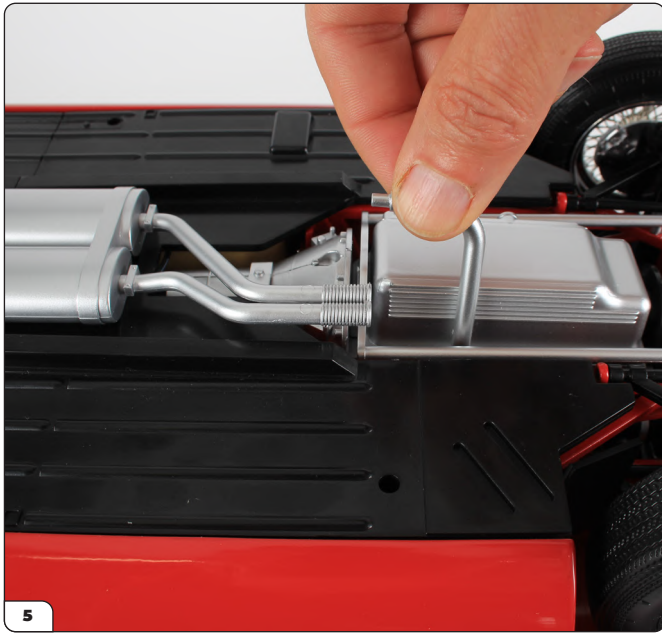

Next, take the shorter front pipe (2) and push the end onto a lug located beside the sump tank.



Plug the other end of the shorter front pipe (2) into the silencer as shown.



Take the longer front pipe (1) and plug it into another lug located beside the sump tank, furthest from the silencer.



Finally, plug the other end into the silencer in the same manner.

## Stage 100: Installing the Exhaust Pipes

---

STAGE COMPLETE



### Build Complete!

We hope you have enjoyed building your Jaguar E-type. Don't forget, when you choose your next model the first Pack is absolutely free! Go to [agoramodels.com](http://agoramodels.com) for more details.

Display cases for your model are also available at [agoramodels.com](http://agoramodels.com).

**!** Warning: to keep your model in pristine condition please keep out of direct sunlight.

# Batteries for the Jaguar E-Type

---

Your model of the Jaguar E-Type uses 3x **LR44** batteries to power the headlights, taillights and hazard lights. These are not included and will need to be purchased separately.

The following instructions show how to install or replace the batteries on your model. The compartment is located underneath the sump of the model, which is push-fit to allow access once the model has been fully assembled.

You will need to place the model upside down while removing the sump – make sure to use a protective surface so the model is not damaged while working on it. We have used two large pieces of foam to mount the model, which allows room for the windscreen while supporting the body.

We recommend having a pair of angled tweezers (such as those supplied with Stage 24) or a similar tool to hand, as this makes it easier to lever two of the push-fit connections while removing the sump.



# Installing or Replacing the Batteries



Carefully lay the model on a protective surface so that the underside is easily accessible.



Start by removing the two front pipes located next to the sump. Pull the pin of each pipe out of the exhaust (circled) then lift the pipe up to remove it.

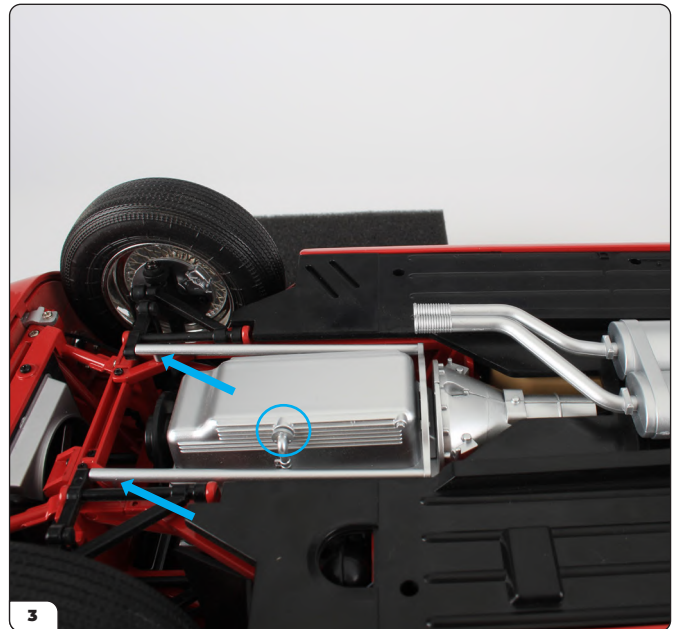

Removing the pipes will make it easier to take the sump out. Note the following connection points: the filter hose (circled) that is fitted into the side of the sump, along with the two points of the torsion bar at the front (arrows).

# Installing or Replacing the Batteries

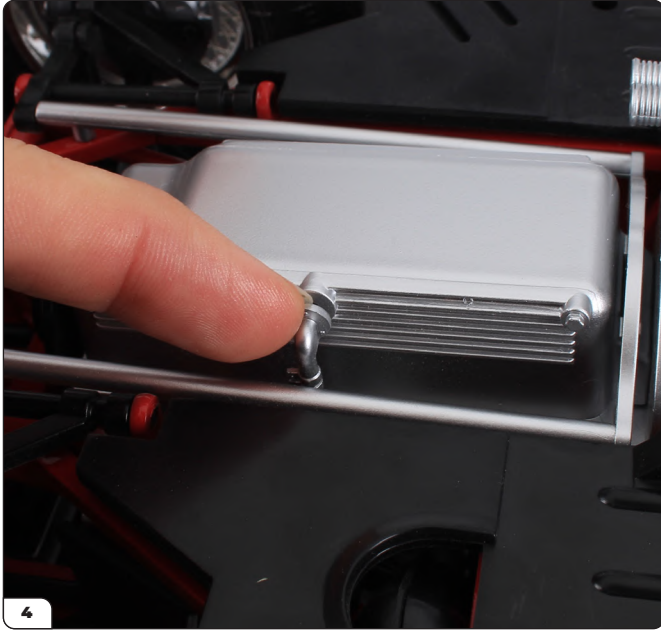

Pull the filter hose out of the sump.

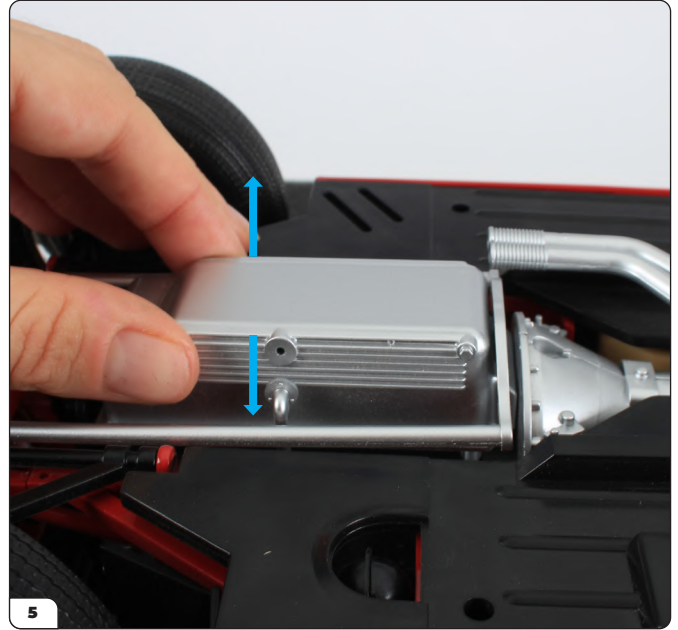

Move the sump back and forth (arrows) to begin loosening the connections to the frame. This will remove the tension in the bars for the next step.

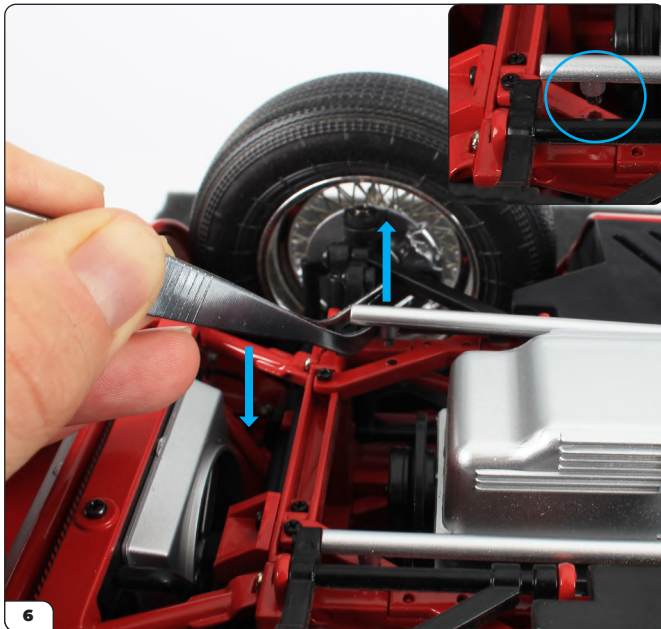

Carefully start lift the first torsion bar from the model. You can use a pair of angled tweezers to lever the bar by inserting it as shown underneath the bar and pushing the tweezers down (arrows). Repeat this for the second torsion bar on the opposite side (inset, circled).



Continue to move the sump back and forth as you did in step 5 then lift it out to reveal the battery compartment.

# Installing or Replacing the Batteries

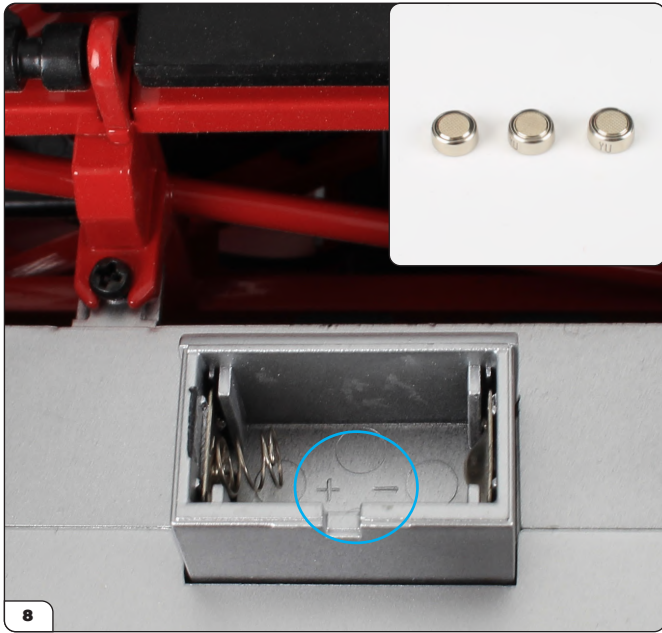

The three batteries are type LR44 (inset). The battery compartment is marked with a positive and negative symbol (circled).

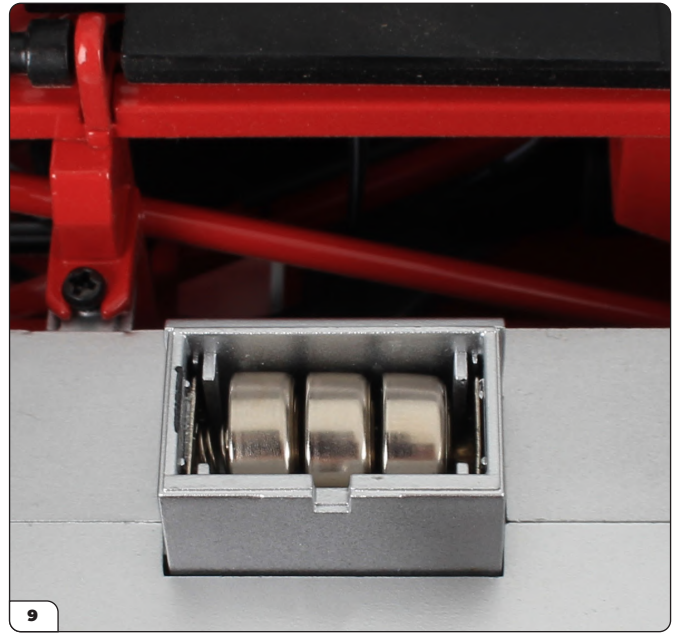

Insert the batteries into the compartment so that the positive and negative sides are facing the correct way.

With the batteries installed, fit everything back into place by reversing the steps. Push the sump back in by pressing the six pins back into the relevant connections, then reattach the filter hose and insert the two front pipes back into position.